

The background of the lower half of the page is a complex geometric pattern. It features a network of black lines forming irregular polygons. Overlaid on this are several semi-transparent shapes: a large red polygon, a smaller blue polygon nested within it, and a green outline that follows the perimeter of the red polygon. Scattered throughout the pattern are numerous circles of varying sizes and shades of gray, some of which have a small red dot in their center.

Intelligent solutions for complex problems

Annual Research Report 2020

Cover figure: Every stationary random open set can be covered by a Voronoi tessellation with the cell centers inside the set and positive minimal distance to the boundary. The distribution of the diameters of the Voronoi cells follows the same law as the radial distribution of the cell centers. This distribution is called the mesoscopic regularity of the geometry and plays a crucial role in the theory of extension operators for stochastic homogenization (WIAS Preprint no. 2849).

Photo Credit Page 47: © tostphoto – stock.adobe.com

Edited by Weierstraß-Institut für Angewandte Analysis und Stochastik (WIAS)
Leibniz-Institut im Forschungsverbund Berlin e. V.
Mohrenstraße 39
D – 10117 Berlin
Germany

ISSN 2198-5898
Berlin 2020

Fax: + 49 30 20372 303
E-Mail: contact@wias-berlin.de
World Wide Web: <https://www.wias-berlin.de/>

The Weierstrass Institute for Applied Analysis and Stochastics, Leibniz Institute in Forschungsvereinigung Berlin e. V. (WIAS, member of the Leibniz Association), presents its Annual Report 2020. It gives a general overview of the scientific life, as well as an account of the scientific progress made in 2020.

The year 2020 will perhaps enter our institute's annals as one of the more challenging ones. While we started out with many activities ranging from research to workshops to several other agendas at the beginning of the year, from March onwards the pandemic required numerous adjustments and changes in our workflows and still does. Many of us are still working from home.

WIAS continues to be among the five cooperation partners of the Cluster of Excellence Berlin Mathematics Research Center MATH+, with its Director one of its three spokespersons. The reporting year brought WIAS 8.5 new MATH+ projects, ranging from microfluidics for lab-on-a-chip applications to the mathematics of deep neural networks.

The new Leibniz Junior Research Group won in 2020 by Dr. Benedikt Jahnel in the Leibniz Competition 2021 on the topic "Probabilistic Methods for Dynamic Communication Networks" aims to understand and predict the influence of device mobility in realistic environments on the system performance.

The Secretariat of the International Mathematical Union (IMU), permanently based at WIAS, is now led by the head of WIAS Research Group 4 *Nonlinear Optimization and Inverse Problems* and IMU Treasurer Prof. Dietmar Hömberg.

Our *work and family* team led our Institute very successfully through the re-audit for the consolidation phase in the *audit berufundfamilie*, documenting our commitment to a sustainable family- and life-phase-conscious personnel policy for making our Institute a highly attractive workplace.

WIAS's primary aim remains unchanged: to combine fundamental research with application-oriented research, and to contribute to the advancement of innovative technologies through new scientific insights.

Again we hope that funding agencies, colleagues, and partners from industry, economy, and sciences will find this report informative and will be encouraged to cooperate with us. Enjoy reading.

Berlin, in March 2021

M. Hintermüller



Prof. Dr. Michael
Hintermüller, Director

Scientific Advisory Board

Chairperson: Prof. DI

Dr. Barbara Kaltenbacher Universität Klagenfurt, Institut für Mathematik
Universitätsstr. 65–67, 9020 Klagenfurt, Austria

Vice-Chairperson:

Prof. Dr. Ulisse Stefanelli Universität Wien, Fakultät für Mathematik
Oskar-Morgenstern-Platz 1, 1090 Wien, Austria

Prof. Dr. Silke Christiansen Fraunhofer-Institut für Keramische Technologien und Systeme IKTS, Head of Korrelative Mikroskopie & Materialdaten
Äußere Nürnberger Straße 62, 91301 Forchheim

Dr.-Ing. Stephan Fell Opel Automobile GmbH, Vehicle CAE
IPC S-1-01, 65423 Rüsselsheim

Prof. Dr. Andreas Greven Universität Erlangen-Nürnberg, Department Mathematik
Cauerstr. 11, 91058 Erlangen

Prof. Dr. Matthias Heinkenschloss Rice University, Department of Computational and Applied Mathematics, P.O. Box 1892, Houston, TX 77005, USA

Prof. Dr. Stefan Kurz Bosch Center for Artificial Intelligence (BCAI)
Robert Bosch GmbH, CR/PJ-AI-R, Renningen, 70465 Stuttgart

Prof. Dr. Markus Reiß Humboldt-Universität zu Berlin, Institut für Mathematik
Unter den Linden 6, 10099 Berlin

Prof. Dr. Robert Scheichl Universität Heidelberg, Institut für Angewandte Mathematik
Im Neuenheimer Feld 205, 69120 Heidelberg

Prof. Dr. Angela Stevens Universität Münster, Angewandte Mathematik Münster
Einsteinstr. 62, 48149 Münster

1	Scientific Highlights	7
1.1	Phase Transitions of Condensation Type in Interacting Particle Systems	8
1.2	Self-consistent Modeling and Simulation of Dynamics in High-power Semiconductor Lasers	14
1.3	Pressure-robust Flow Discretizations on General Polyhedral Meshes	19
1.4	Learning-enriched Differential Equation Models in Optimal Control and Inverse Problems	25
1.5	Numerical Methods for Innovative Semiconductor Devices – An Outlook	31
1.6	Thematic Einstein Semester “Energy-Based Mathematical Methods for Reactive Multiphase Flows”	36
1.7	Stochastic Optimal Control by Reinforced Regression	42
2	WIAS in 2020	47
2.1	Profile	48
2.2	Structure and Scientific Organization	49
2.2.1	Structure	49
2.2.2	Main Application Areas	51
2.2.3	Contributions of the Groups	51
2.3	Equal Opportunity Activities	56
2.4	Grants	58
2.5	Participation in Structured Graduation Programs	58
2.6	Scientific Software	59
3	IMU@WIAS	61
3.1	<i>IMU@WIAS</i>	62
3.2	IMU and its Secretariat in 2020	64
3.3	Ad hoc Committee on Diversity	65
3.4	ICMI: An unusually challenging year	66
3.5	Overview of Events 2020 and Beyond	68
4	Research Groups’ Essentials	71
4.1	RG 1 <i>Partial Differential Equations</i>	72
4.2	RG 2 <i>Laser Dynamics</i>	77
4.3	RG 3 <i>Numerical Mathematics and Scientific Computing</i>	81
4.4	RG 4 <i>Nonlinear Optimization and Inverse Problems</i>	85
4.5	RG 5 <i>Interacting Random Systems</i>	90
4.6	RG 6 <i>Stochastic Algorithms and Nonparametric Statistics</i>	94
4.7	RG 7 <i>Thermodyn. Modeling and Analysis of Phase Transitions</i>	100
4.8	RG 8 <i>Nonsmooth Variational Probl. and Operator Equations</i>	104
5	Flexible Research Platform	109
5.1	WG 1 <i>Bulk-Interface Processes</i>	110
5.2	LG 5 <i>Numerical Methods for Innovative Semiconductor Devices</i>	113

A	Facts and Figures	117
A.1	Offers, Awards, Ph.D. Theses, Supervision	118
A.1.1	Offers of Professorships	118
A.1.2	Awards and Distinctions	118
A.1.3	Defenses of Ph.D. Theses	118
A.1.4	Supervision of Undergraduate Theses	119
A.2	Grants	121
A.3	Membership in Editorial Boards	129
A.4	Conferences, Colloquia, and Workshops	131
A.4.1	Oberwolfach Workshops co-organized by WIAS	134
A.5	Membership in Organizing Committees of non-WIAS Meetings	135
A.6	Publications	136
A.6.1	Monographs	136
A.6.2	Editorship of Proceedings and Collected Editions	136
A.6.3	Outstanding Contributions to Monographs	136
A.6.4	Articles in Refereed Journals	137
A.6.5	Contributions to Collected Editions	146
A.7	Preprints, Reports	149
A.7.1	WIAS Preprints Series	149
A.7.2	Preprints/Reports in other Institutions	155
A.8	Talks and Posters	157
A.8.1	Main and Plenary Talks	157
A.8.2	Scientific Talks (Invited)	157
A.8.3	Talks for a More General Public	162
A.8.4	Posters	162
A.9	Visits to other Institutions	164
A.10	Academic Teaching	165
A.11	Visiting Scientists	169
A.11.1	Guests	169
A.11.2	Scholarship Holders	170
A.11.3	Doctoral Candidates and Post-docs supervised by WIAS Collaborators	170
A.12	Guest Talks	171
A.13	Software	174

1 Scientific Highlights

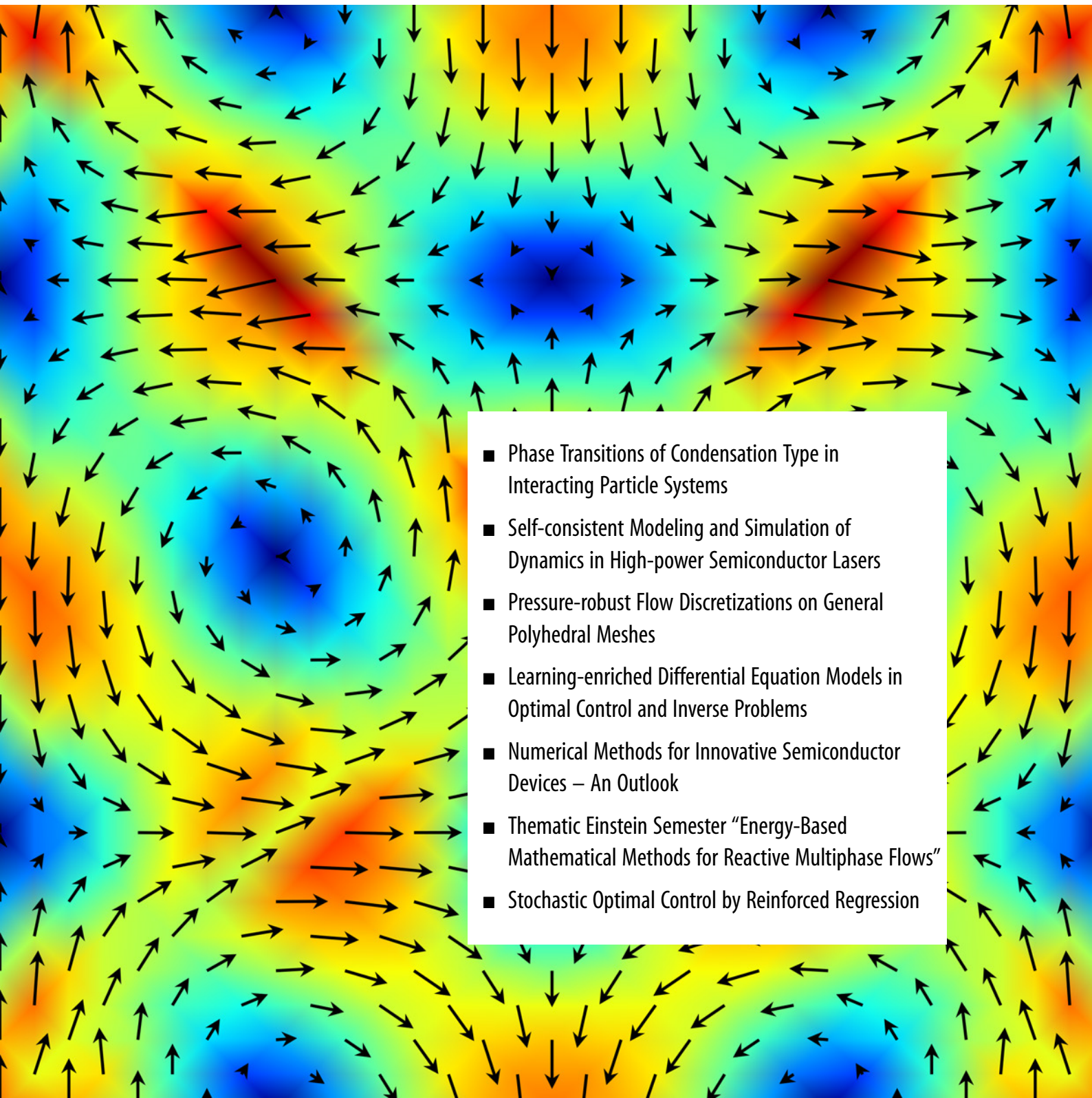
- 
- Phase Transitions of Condensation Type in Interacting Particle Systems
 - Self-consistent Modeling and Simulation of Dynamics in High-power Semiconductor Lasers
 - Pressure-robust Flow Discretizations on General Polyhedral Meshes
 - Learning-enriched Differential Equation Models in Optimal Control and Inverse Problems
 - Numerical Methods for Innovative Semiconductor Devices – An Outlook
 - Thematic Einstein Semester “Energy-Based Mathematical Methods for Reactive Multiphase Flows”
 - Stochastic Optimal Control by Reinforced Regression

1.1 Phase Transitions of Condensation Type in Interacting Particle Systems

Benedikt Jahnel, Wolfgang König, and Alexandra Quitmann

One of the greatest unsolved problems in contemporary mathematical physics is a mathematical understanding of the famous *Bose–Einstein condensation (BEC)* phase transition. In 1924, the young and then unknown Indian mathematical physicist Satyendra Nath Bose kindly asked the already famous Albert Einstein to help publishing his achievement, a new calculation method for the free energy of a simple model (i.e., without particle interactions) for a large particle system at very low temperatures. Einstein helped him, but also noticed that this new method even had detected a previously unknown and very weird phase transition, in particular, a new kind of condensation phase of an ensemble of undistinguishable particles. In this state of matter, a positive fraction would remain in the same quantum mechanical state, a kind of “super atom” having strange properties. He predicted that this effect would arise also at positive, but very low temperature and under realistic conditions, i.e., with some interaction between the particles.

For a long time, this prediction did not lead to much research activity, since the anticipated phase transition was seen mostly as a kind of curiosity, a mathematical foundation seemed to represent a major undertaking, and an experimental verification was far out of reach. Nevertheless, a few theoretical physicists started developing some preliminary modeling in the 1940s and triggered the interest of the physics community. By the 1990s, the opinion emerged that an experimental realization would be a hot candidate for a Nobel Prize. In 1992, a team of experimental physicists created a temperature of 10^{-6} Kelvin for some ten thousands of particles, which did not suffice for obtaining the condensation, but led to the Physics Nobel Prize being awarded for the year 1997. In 1995, finally, two teams reached a temperature of 10^{-9} Kelvin and did obtain the condensation phase experimentally. As expected, three members of the two teams were awarded jointly the Physics Nobel Prize for the year 2001 for this success. This development triggered substantial activity by mathematical physicists and later probabilists searching for a rigorous mathematical understanding of BEC. Since then, for many simplified models, this phase transition has been successfully analyzed mathematically, but not in the situation that is considered the most realistic and important one, namely the thermodynamic limit of the canonical model at positive temperature with some pair interaction between the particles, the *interacting quantum Bose gas*.

The interacting quantum Bose gas

There is a generally acknowledged model for the description of the predicted condensation effect. It is given via an ensemble of many interacting Brownian bridges (Brownian motions conditioned on terminating at their initial site) of various lengths of their time intervals, where the number of particles carried by a bridge is proportional to this length. The condensation effect is seen in the emergence of a positive fraction of the particles that sit in cycles of lengths that tend to infinity as the total particle number diverges. This positive fraction is—in this model—equal to the Bose–Einstein condensate. The famous conjecture is that it exists in dimensions larger or equal to three

at sufficiently low temperatures (or equivalently at sufficiently large particle densities), but not in dimensions less than or equal to two. More precisely, this phase transition is expected to be a *saturation effect*, i.e., up to a certain critical particle density, all particles should be organized in microscopic structures (i.e., in cycles of finite lengths), and if this threshold is exceeded, then the condensate emerges, and the microscopic structures remain essentially unchanged if the particle density is further increased. Each of the long cycles corresponds to an above said “super atom”, the novel aggregate state of matter that fascinated Einstein and Bose.

Let us give a more precise description of the model. We consider a canonic interacting bosonic many-body system in a large box in \mathbb{R}^d at positive temperature $1/\beta \in (0, \infty)$ with fixed particle density $\rho \in (0, \infty)$ and kinetic energy in the thermodynamic limit, i.e., N particles in a large box Λ_N of volume N/ρ . We denote by

$$\mathcal{H}_N = - \sum_{i=1}^N \Delta_i + \sum_{1 \leq i < j \leq N} v(|x_i - x_j|), \quad x_1, \dots, x_N \in \Lambda_N,$$

the N -particle *Hamilton operator* with kinetic energy given by the Laplace operator and mutual energy given by a pair-interaction function $v: [0, \infty) \rightarrow \mathbb{R}$. There is no particular canonical choice of v in view of the Bose gas, but a typical requirement is a short-distance repulsion (i.e., $v(r) \rightarrow \infty$ as $r \downarrow 0$) and a strong decay at infinity. Otherwise, one requires v often to be nonnegative or of *Lennard-Jones-type*, i.e., with some attraction at moderate distance (i.e., a strict negative minimum at some positive point). We are interested in *bosons* and introduce a symmetrization, i.e., we project \mathcal{H}_N on the set of symmetric, i.e., permutation-invariant, wave functions. For this, we consider the trace of the operator $e^{-\beta \mathcal{H}_N}$ in Λ_N with symmetrization,

$$Z_N(\beta, \Lambda_N) = \text{Tr}_{\Lambda_N, +}(e^{-\beta \mathcal{H}_N}), \tag{1}$$

where the index $+$ indicates the symmetrization. This trace is the *partition function* of the model, the integral over all realizations of the system of N indistinguishable particles in Λ_N , equipped with the two energies. The kinetic energy is expressed in terms of an expectation with respect to N Brownian bridges (cycles) on the time interval $[0, \beta]$, and the symmetrization appends each bridge at the end of another, according to some uniformly-at-random-picked permutation of the N bridges. Since every permutation decomposes into cycles, these bridges are glued together to bridges of various time lengths, by the virtue of the Markov property. This is summarized in terms of a well-known variant of the *Feynman–Kac formula*, which we formulate now.

For $k \in \mathbb{N}$, we put $q_k = \frac{1}{k}(4\pi\beta k)^{-d/2}$ and pick the starting sites of all the bridges of length k (i.e., with time interval $[0, \beta k]$) as the points of a *Poisson point process* with intensity q_k ; hence they are uniformly distributed over Λ_N , and their number is Poisson distributed with expectation $q_k |\Lambda_N|$. Each bridge B of length k has exactly k particles $B_0, B_\beta, B_{2\beta}, \dots, B_{(k-1)\beta}$ and has k legs $(B_t)_{t \in [(j-1)\beta, j\beta]}$ with $j = 1, \dots, k$. All these families of cycles are independently superposed over $k \in \mathbb{N}$, and the total number of all the motions is put equal to N . The interaction of the ensemble is equal to a sum over all pairs of any two legs of any of the bridges and given by the

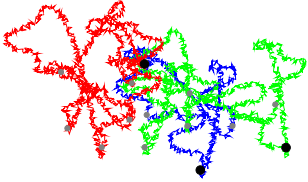

Fig. 1: Illustration of three Brownian cycles (red, blue, green) attached to Poisson points (black) and carrying particles (gray)

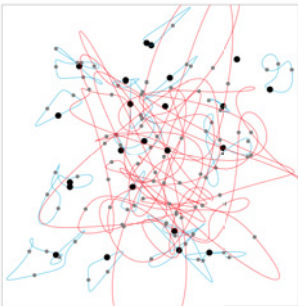
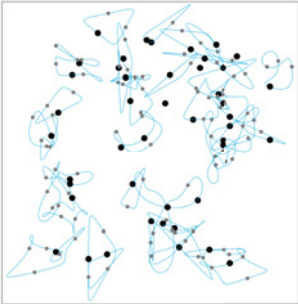

Fig. 2: Up: Illustration of a cycle ensemble without emergence of a condensate. Down: Illustration of a cycle ensemble with a very long cycle (red), interpreted as condensate

functional

$$(f, g) \mapsto \int_0^\beta v(f(t) - g(t)) dt. \quad (2)$$

Let us denote the ensemble by $\mathfrak{B} = (B^{(k,i)})_{k,i}$ with corresponding expectation \mathbb{E} and the total interaction by \mathfrak{V} , then the announced trace formula reads

$$Z_N(\Lambda_N) = \mathbb{E} \left[e^{-\mathfrak{V}} \mathbb{1}\{L(\mathfrak{B}) = N\} \right], \quad (3)$$

where $L(\mathfrak{B})$ denotes the total number of particles in the system, i.e., the sum of all the lengths of the cycles. We have arrived at a probabilistic description of the trace in terms of an interacting ensemble of many random cycles (in this case, Brownian bridges) of various, unbounded lengths, with a pair interaction for each pair of legs and a total number of N legs. In particular, this is a spatial distribution of N indistinguishable particles in terms of a marked Poisson point process in the box Λ_N , see Figure 1.

The main goal is to prove that, in the limit as $N \rightarrow \infty$, in dimension $d \geq 3$ (but not in $d \leq 2$) and for all sufficiently large particle densities ρ , the main contribution to this expected value comes from those configurations that have a *positive fraction of particles* (i.e., of legs) in “very long” cycles, i.e., cycles of lengths that depend on N and diverge as $N \rightarrow \infty$, see Figure 2. The totality of all these long cycles is then interpreted as the *condensate*. The occurrence of such a macroscopic structure at sufficiently large particle density is supposed to be a *condensation phase transition*, i.e., there should be a critical threshold $\rho_c \in (0, \infty)$ such that long cycles occur for $\rho > \rho_c$, but not for $\rho < \rho_c$. The idea is that, if ρ grows, i.e., when adding more and more particles to the container Λ_N , then first the particles are organized in finite-length cycles until *saturation* is reached, and if the threshold ρ_c is exceeded, then all additional particles condensate, and the density of the finite-cycle particles does not change anymore.

Large deviations ansatz

One familiar ansatz for deriving large- N asymptotics for the partition function is based on the idea to derive a *characteristic variational formula* for its large- N exponential rate, i.e., for the *free energy* per unit volume, given by

$$f(\rho) = - \lim_{N \rightarrow \infty} \frac{1}{|\Lambda_N|} \log Z_N(\Lambda_N).$$

This formula should be able to express the contributions of the decisive quantities like energy, entropy, and particle density in terms of an infimum over all the three random ingredients (cycle lengths, locations of Poisson points, cycle trajectories), to distribute all the random cycles. A decisive step towards this aim was made in [1], where, for all sufficiently small ρ , it was proved that

$$f(\rho) = \inf \{ I(P) + \Phi(P) : P \in \mathcal{M}_1^{(s)}, \mathcal{N}(P) = \rho \}, \quad (4)$$

where $\mathcal{M}_1^{(s)}$ is the set of (distributions P of) translation-invariant marked point processes in \mathbb{R}^d (the marks being the random cycles starting and ending at the points); furthermore, $I(P)$ is the *relative entropy density* of P with respect to the above reference Poisson point process, $\Phi(P)$ the

energy of P , and $\mathcal{N}(P)$ the *effective particle density* of P , i.e., the number of particles that P puts on an average into a unit volume. It should be noted that P is able to express only microscopic structures, not the condensate.

The methods employed in [1] failed to extend this statement to all particle densities ρ , nor to say anything about the existence nor non-existence of minimizers P in that formula. The latter question is conjectured to be decisive for the question about occurrence of BEC. Indeed, if the formula admits a minimizer, then this should be interpreted as the non-existence of a condensate, while a lack of a minimizer should indicate that there is something in the system that cannot be expressed in terms of such processes P – this should be the condensate. It is conjectured by the WIAS team that there is a critical value ρ_c (which is finite in dimensions $d \geq 3$) such that a minimizer P exists for $\rho < \rho_c$, but not for $\rho > \rho_c$. Mathematically, much of the problem stems from the fact that the map $P \mapsto \mathcal{N}(P)$ is lower semicontinuous, but not continuous.

In order to solve a problem of this kind, a WIAS team worked in 2020 on a slightly simplified model, where \mathbb{R}^d is replaced by the lattice \mathbb{Z}^d and the (random) Brownian cycles are replaced by (deterministic) grids, see Figure 3 for an illustration. The team is about to finish the derivation of a characteristic variational formula that features a serious extension of (4): an extended probability space that is able to encode also the macroscopic structure:

$$f(\rho) = \inf_{\rho_1 \in [0, \rho]} \inf_{\psi \in \mathcal{M}_1(\mathbb{N}_0)} \inf_{\sum_{a \in \mathbb{N}_0} a \psi(a) = \rho - \rho_1} \inf \{ I(P_\psi) + \Phi(P_\psi) : P_\psi \in \mathcal{M}_1^{(s)}, \mathcal{N}(P_\psi) = \rho_1 \}.$$

Here, $\psi(a)$ is the percentage of the area in which precisely a macroscopic grids overlap (this defines something like an environment of condensates), and P_ψ is the distribution of the microscopic grids given the spatial distribution of the condensate and $\Phi(P_\psi)$ its total expected energy (within and between all microscopic and macroscopic particles), and $\mathcal{N}(P_\psi)$ is the number of microscopic particles that P_ψ puts on an average at one site. Then ρ_1 is the particle density in microscopic grids, and $\rho - \rho_1$ is the density of particles in the condensate.

This formula admits a minimizer for any value of ρ and a clear distinction between the mass of microscopic particles and the condensate. Standard variational techniques give criteria for existence of minimizers with a non-trivial value of $\rho - \rho_1$. The WIAS team is working on a proof that, as long as $\sum_k k q_k$ is finite (recall that q_k is the spatial *a priori* density of cycles of length k), this criterion is satisfied for any sufficiently large ρ , i.e., a proof of the occurrence of BEC in this model. We are confident of addressing the original interacting quantum Bose gas with an extension and adaptation of this methodology in the future.

Reflection positivity ansatz

A second approach, which is currently explored by another WIAS team, consists of an application of reflections to the family of random cycles and the deduction of useful correlation inequalities. This technique has previously produced good results in models of random cycles (often called *random loops* in this connection) in the spatially and temporally discrete setting, and offers good perspectives for extensions to the interacting quantum Bose gas in the future. Currently, there is a high interest in the study of models of interacting random loops in large boxes of various types,

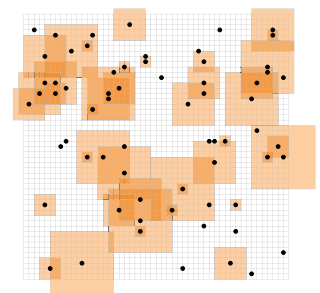

Fig. 3: Illustration of a realization of the simplified quantum Bose gas in a finite box. Poisson points on \mathbb{Z}^d carry marks given by finite grids of varying size

written in terms of random geometric permutations in the spirit of the formulation of the trace in (1) above; see [2].

The model to which this technique was applied in 2020 at WIAS is the following. We work in a large box in \mathbb{Z}^d with nearest-neighbor edges (and periodic boundary conditions). On each edge in the box, there is a random number of links connecting the two vertices, satisfying the constraint that the number of links connecting any vertex is even. Each link connecting a vertex is paired to precisely one other link connecting that vertex. As a result, we obtain a random collection of closed loops as in Figure 4. We denote by m_e the number of links on the edge e and by n_x the number of pairings at the vertex x . A given configuration obtains a weight proportional to

$$\left(\prod_{\text{edges } e} \frac{\gamma^{m_e}}{m_e!} \right) \left(\prod_{\text{vertices } x,y} e^{-v(|x-y|)n_x n_y} \right) K^{\# \text{ loops}}, \quad (5)$$

where $v: [0, \infty) \rightarrow \mathbb{R}$ is an interaction function like in (2), and $\gamma, K \in (0, \infty)$ are two parameters. The parameter γ controls the number of links and, hence, also the number of particles, i.e., it plays the role of the particle density (called ρ above). Large values of the parameter K favor a large number of loops, i.e., suppress their lengths. This random loop model is defined in the spirit of the interacting quantum Bose gas; however, the precise relation between the two models is not clear yet.

For this model the team is in progress to prove the existence of a regime of occurrence of macroscopic loops for all sufficiently large values of γ . The central technique uses a special property of the random loop measure, which is a correlation inequality called *reflection positivity*. For an arbitrary plane through edges that is orthogonal to one of the Cartesian axes, we consider a bilinear form defined on the set of functions that depend only on the configuration on one half of the box. It is given by the expected value of the product of two such functions, where one of them is reflected at the plane. Reflection positivity means that this bilinear form is symmetric and positive semidefinite, giving us a Cauchy–Schwarz-type inequality. The first step is to prove that the random loop measure (5) indeed enjoys this property, which is due to the particular form of its weights and to the periodic boundary conditions.

The by far more serious part is to use this correlation inequality to derive, for sufficiently large γ , a positive lower bound on the expected length of the loops, uniformly in the volume of the box. (This part is too involved to be explained here.)

The technique of reflection positivity was developed in the late 1970s by Fröhlich, Simon and Spencer who employed it for establishing the occurrence of a phase transition in lattice spin models. In [3], this property was used to prove a phase transition in a modified version of the above model, in which the “loop” containing the origin is open, i.e., it starts at the origin and ends at an arbitrary vertex of the box that differs from the origin.

For $K = 2$, the team is convinced that they will obtain a connection with the spatially discrete and temporally continuous version (i.e., with continuous-time random walks in \mathbb{Z}^d) of the interacting quantum Bose gas, at least in the grand canonical ensemble (where the particle number is not fixed, but a Poisson random number).

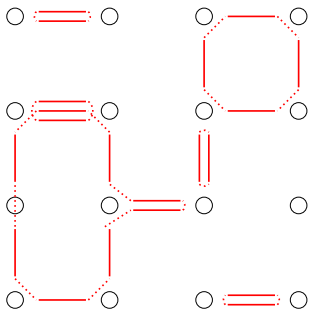

Fig. 4: Representation of a link and pairing configuration with six closed loops. The circles represent the vertices of the graph. Paired links are connected by a dotted line

References

- [1] S. ADAMS, A. COLLEVECCHIO, W. KÖNIG, *A variational formula for the free energy of an interacting many-particle system*, *Ann. Probab.*, **39**:2 (2011), pp. 683–728.
- [2] V. BETZ, *Random permutations of a regular lattice*, *J. Statist. Phys.*, **155** (2014), pp. 1222–1248.
- [3] L. TAGGI, *Uniformly positive correlations in the dimer model and phase transition in lattice permutations in Z^d , $d > 2$* , WIAS Preprint no. 2647, 2019, to appear in: *Commun. Pure Appl. Math.*

1.2 Self-consistent Modeling and Simulation of Dynamics in High-power Semiconductor Lasers

Mindaugas Radziunas and Uwe Bandelow

High-power (HP) broad-area edge-emitting semiconductor lasers (BALs) are compact, cheap, and reliable devices used in many modern applications. These devices have a relatively simple geometry, see Figure 1(a), allowing efficient energy pumping through a broad electric contact on the top of the device, and they can operate at high power (tens of watts) regimes. In many applications, BALs receive delayed optical feedback from external cavities (EC), see Figure 1(b), which can be used to improve the emission properties or to couple several BALs into a single system [1, 2].

Fig. 1: Scheme of a high-power broad-area laser (a), top view (with EC) (b), and transverse cross section with optically active zone (AZ) (c). The computational domains of model components are indicated in (b) and (c), whereas the diagram (d) illustrates the coupling of these models.

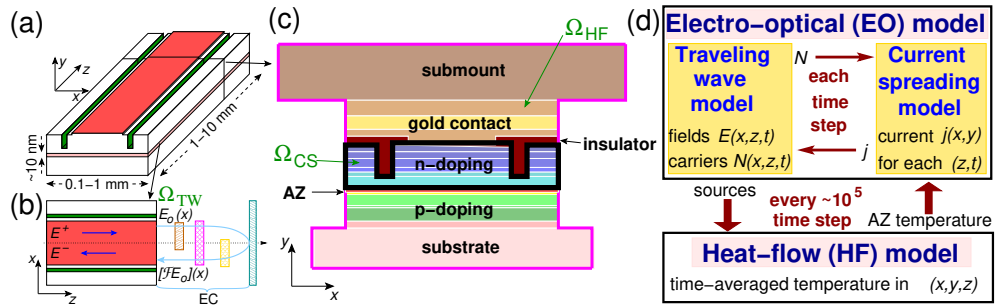

However, operated at high power, many nonlinear processes take over, such as heating, multimode dynamics, and optical filamentation [3], [4], see Figure 2(a). As a result, the emitted optical beam is irregular, has undesirable broad optical spectra, and a large divergence. A deep understanding of the spatiotemporal dynamics in HP-BALs is needed for improving devices and novel design concepts. We model these effects at different levels of complexity [5], analyze the hierarchy of models mathematically [4], create and implement efficient and robust numerical algorithms [5, 6] into the WIAS software kit `BALaser` together with `RG 3 Numerical Mathematics and Scientific Computing`, and simulate the models typically in close collaboration with physicists and engineers in the frame of research projects [2, 3, 6].

Models, their coupling, and numerical solution strategy

Our dynamical model of HP-BALs is composed of several self-consistently coupled model components [4, 6], each operating in its own computational domain, see Figure 1(b,c,d).

Electro-optical model. The core is the traveling wave (TW) model for the envelopes E^+ and E^- of the counterpropagating optical fields, and the carrier density N within the active zone (AZ) [5]:

$$\partial_t E^\pm = [-i\partial_{xx} \mp \partial_z - ik_0(n_N(N) + n_T(T)) - \alpha + G(N, |E|) - \mathcal{D}] E^\pm + i\kappa E^\mp + F_{sp}^\pm \quad (1a)$$

$$\frac{1}{\epsilon} \partial_t N = \partial_x(d_N(x, z)\partial_x N) + j(x, z) - R(N) - \Re \sum_{\nu=\pm} E^{\nu*} (G - \mathcal{D}) E^\nu. \quad (1b)$$

n_N and n_T model the carrier and heat dependence of the refractive index, α , G , and \mathcal{D} are the loss, the net optical gain, and its dispersion. The coupling coefficient κ accounts for the presence of Bragg gratings, and the Langevin noise term F_{sp} models spontaneous emission. In the diffusion equation for the carriers (1b), j is the injected current density, R the spontaneous recombination, and the last term the stimulated carrier recombination. At the laser facets, $z = 0$ and $z = l$, the field equations in (1a) are supplemented with reflecting-reinjecting boundary conditions:

$$E^+(x, 0, t) = r_0 E^-(x, 0, t), \quad E^-(x, l, t) = r_l E^+(x, l, t) + (1 - |r_l|^2) [\mathcal{F}E^+(\cdot, l, \cdot)](x, t), \quad (2)$$

with reflection coefficients r_0 and r_l . The nonlocal linear operator \mathcal{F} represents optical feedback, see Figure 1(b), the derivation of which for specifically designed external cavities, and its efficient numerical evaluation for dynamically varying emission is a nontrivial task by itself [1, 2].

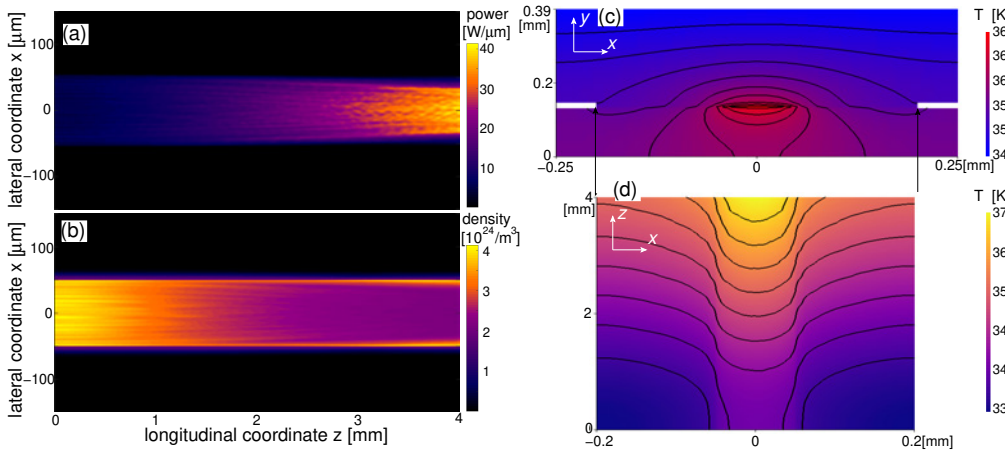

Fig. 2: (a) and (b): Time-averaged field intensity $|E(x, z)|^2$ showing filaments, and carrier density $N(x, z)$ in the active zone, calculated by the electro-optical solver. (c) and (d): Time-averaged temperature $\bar{T}(x, y, z)$ within a transverse cross section and corresponding distribution $\bar{T}_{AZ}(x, z)$ along the active zone, provided by the heat-flow solver.

The traveling wave model (1), (2) was extensively used for the analysis of BAL devices over the last decade, where it provided information on the main characteristics of the emission and details on the internal field and carrier distributions, Figure 2(a),(b)¹. It is the computationally most demanding part of the coupled model; see Figure 1(d). The numerical method relies on finite differences and a split-step method for the field equations. The algorithm was parallelized using a distributed-memory paradigm. Depending on the domain's size, discretization, and the number of parallel processes, typical calculations take between a few minutes up to several hours for 1-ns long transients [5].

Simultaneously with the traveling wave model (1), (2), we calculate the current spreading (CS) in multiple cross-sections Ω_{CS} of the BAL, see thick-black framed domain in Figure 1(c) [3]:

$$\nabla_{x,y} \cdot (\sigma(x, y; z) \nabla_{x,y} \phi(x, y)) = 0, \quad \forall z \in (0, l), \quad (x, y) \in \Omega_{CS}. \quad (3)$$

The electrical conductivity σ together with the calculated Fermi potential ϕ define the injection current density j and diffusion d_N that enter (1b). Together with the traveling wave model, the current spreading problem (3) completes the electro-optical (EO) model, see Figure 1(d). When treating (3), we exploit finite volume schemes and the WIAS software toolkit pdelib. The traveling

¹On this level, thermal effects have been included only by a static, z -independent function $n_T(x)$ [5].

wave equations and current spreading problem solvers should exchange data during each time iteration. For the acceleration of calculations, we precalculate elementary solutions, use the current spreading problem's linearity and a Green-function-like approach [6].

Heat flow model. Due to the significant heating of the devices, we have extended the EO model above by a heat-flow (HF) model, which replaces earlier considered static contributions to the refractive index [5] by self-consistent heating-induced corrections of several parameters of the EO model. Instead of solving the classical macroscopic (1+3)-D heat-flow equation, we decompose the temperature distribution $T = \bar{T} + \Delta_T(t)$ and heat generation rate $h = \bar{h} + \Delta_h(t)$ in a time-average mean and a time-fluctuating part with zero average. With further approximations [4], the dynamic heat-flow equation splits into

$$c_h(x, y, z) \frac{\partial \Delta_T(x, y, z, t)}{\partial t} = \Delta_h(x, y, z, t), \quad \forall z \in (0, l), \quad (x, y) \in \Omega_{\text{HF}}. \quad (4)$$

$$\nabla_{x,y} \cdot (\kappa_L(x, y; z) \nabla_{x,y} \bar{T}(x, y; z)) = -\bar{h}(x, y; z),$$

The first equation represents sub-ns scale fluctuations of the temperature, which can be important in high-power or in pulsed injection regimes [4]. The second equation in (4) is involved in data exchange between the EO and HF solvers, see Figure 1(d), giving the time-averaged three-dimensional distribution $\bar{T}(x, y, z)$, Figure 2(c), which has to be updated according to changes of the heat sources, typically on the ns-scale. After averaging, we obtain the mean temperature $\bar{T}_{AZ}(x, z)$ in the active zone, Figure 2(d), needed to update the EO model parameters consistently. The heat sources on the right-hand side of this equation, Figure 2(a),(b), are obtained in preceding calculations with the EO solver. For the numerical solution of this problem, we use finite-volume schemes and the pdelib toolkit [6]. For typical lasers, the calculation time required by the HF solver does not exceed a few minutes and, usually, is much smaller than the time required by the EO solver.

The EO and HF solvers are self-consistently coupled using the iterative procedure [6]. From initial transient calculations with the dynamic EO solver, time-averaged heat source distributions are obtained. Next, with these heat sources the static HF problem is solved. From the resulting temperature profile, the parameters of the EO problem are updated, in particular, the thermally induced index distribution, for the next step in this iteration. Usually, the algorithm converges already after a few iterations, see Figure 3. There, time-averaged far-field distributions are displayed on the left, corresponding refractive index profiles on the right, obtained for subsequent iteration steps. Initially, the temperature is constant, resulting in unrealistic narrow far fields (top black curve). The second iteration provides already a quite realistic far field and corrected profile of n_T . The following iterations change the far fields only little around $\pm 6^\circ$ as well as n_T (see inset of the right panel). After approximately the seventh iteration (35 ns transient simulations after switching on the laser), no more significant changes can be observed.

Example: Beam combining by a filtering external cavity

Below, we present a brightness- and power-scalable polarization beam-combining setup for HP-BALs. To achieve a beam combination, which preserves spectral, angular, and spatial characteristics of the individual emitters, we exploit Lyot-filtered optical reinjection from an external cavity. It forces the diodes to emit on interleaved frequency combs with overlapping envelopes and en-

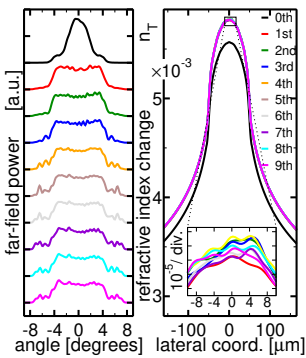

Fig. 3: Far fields (left) and thermal corrections to the refractive index at the facet (right) during iterations of EO and HF solvers

ables a high optical coupling efficiency. Repeatedly introduced new stages of the external cavity, see Figure 4, allow efficient coupling of 2^n emitters. Properly arranged polarization beam splitters and birefringent crystals form Lyot filters, which exploit an interplay of orthogonally polarized field components and provide wavelength-periodic filtering of the propagating fields.

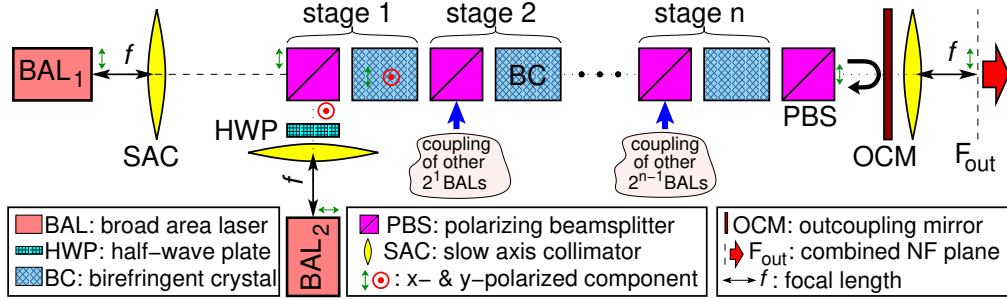

Fig. 4: Coupling of 2^n emitters by an n -staged cascaded external cavity containing various properly located optical elements. The coupling of the first two diodes within Stage 1 is shown explicitly.

The external cavity causes differently filtered optical re-injections $\mathcal{F}_j E^+$ to each emitter BAL_{*j*}, which can be incorporated into the traveling wave model by specific boundary conditions (2):

$$[\mathcal{F}_j E^+(\cdot, l, \cdot)](x, t) = \sum_{k=1}^{2^n} [M_{[j,k]} E_k^+(\cdot, l, \cdot)](x, t).$$

Operators $M_{[j,k]}$ transfer the emission of BAL_{*k*} to BAL_{*j*}. The combined beam behind the outcoupling mirror at the plane F_{out} , see Figure 4, is a sum of 2^n fields E_k^c , which are emissions of individual diodes translated along the external cavity, $E_k^c(x, t) = [M_{[k]} E_k^+(\cdot, l, \cdot)](x, t)$, by means of operators $M_{[k]}$. For properly constructed external cavities, $M_{[j,k]}$ and $M_{[k]}$ are sums of several telescope-type operators, each introducing a different time delay, a phase shift, and a coordinate swap [1, 2]. Being local in time and space, the translation operators could be efficiently integrated into our solver.

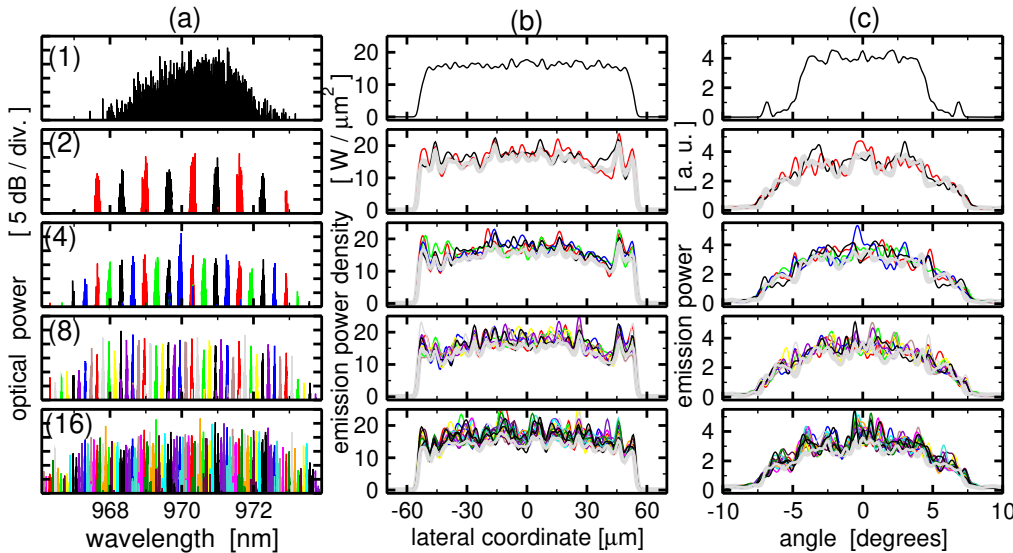

Fig. 5: Simulations of a single diode without feedback (1) and 2/4/8/16 coupled BALs (corresponding lower rows). Optical spectra (a), near-field intensities of the individual diode emission at their front facets (b), as well as corresponding far-field distributions (c). The combined beam (divided by the number of emitters) behind the outcoupling mirror is indicated by the thick grey line in (b) and (c).

We have simulated a single and 2/4/8/16 coupled diodes, each emitting ~ 12 W [2]. Individual interleaving optical spectra, near- and far-field distributions, as well as (scaled) combined beams of

these laser configurations are shown in Figure 5. The coupling scheme induces only a slight broadening of the spectral, spatial, and angular characteristics of the combined beam, compared to the single BAL characteristics (upper diagrams in Figure 5). The combined beam power up-scales with the number of diodes and is proportional to the coupling efficiency, which was 92.7, 89.3, 88.8, and 86.5% for 2, 4, 8, and 16 coupled BALs. The efficiencies calculated for idealized lossless external cavities are well above those of 75–80% reported for two coupled laser bars in experiments [2]. We have repeated simulations introducing 4% intensity loss within each coupling stage. The efficiency dropped to 89% and 72% in two- and sixteen-coupled-diode cases, respectively. Thus, minimization of the field losses in the external cavities is a big demand for the design of such systems.

Conclusions and outlook

We reported on a self-consistent model and software that simulates spatial-temporal dynamics in high-power broad-area edge-emitting semiconductor lasers under the impact of optical feedback and self-heating effects. The current spreading and the heat-flow models have been developed in close collaboration with our partners from Ferdinand Braun Institute, Berlin, in the frame of the BMBF-EffiLas projects. Our modeling and software tool was successfully used to optimize existing lasers and design novel high-power laser setups. For example, our modeling, simulations, and analysis performed in the frame of Eurostars project HIP-Lasers have identified the main challenge arising during the construction of cascaded beam-combining schemes of 2^n emitters, which is the minimization of field losses at the optical elements within the external cavity.

References

- [1] M. RADZIUNAS, J. MONTIEL-PONSODA, G. GARRE-WERNER, V. RAAB, *Simulation of cascaded polarization-coupled systems of broad-area semiconductor lasers*, in: Proc. 20th Int. Conf. on Numerical Simulation of Optoelectronic Devices — NUSOD 2020, J. Piprek, K. Hinzer, eds., IEEE Conf. Publ. Management Group, Piscataway, 2020, pp. 97–98.
- [2] C. BREE, V. RAAB, J. MONTIEL-PONSODA, G. GARRE-WERNER, K. STALIUNAS, U. BANDELOW, M. RADZIUNAS, *Beam-combining scheme of high-power broad-area semiconductor lasers with Lyot-filtered reinjection: Modeling, simulations, and experiments*, J. Opt. Soc. Amer. B Opt. Phys., **36** (2019), pp. 1721–1730.
- [3] A. ZEGHUZI, M. RADZIUNAS, H.-J. WÜNSCHE, J.-P. KOESTER, H. WENZEL, U. BANDELOW, A. KNIGGE, *Traveling wave analysis of non-thermal far-field blooming in high-power broad-area lasers*, IEEE J. Quantum Electron., **55** (2019), pp. 2000207/1–2000207/7.
- [4] U. BANDELOW, M. RADZIUNAS, A. ZEGHUZI, H.-J. WÜNSCHE, H. WENZEL, *Dynamics in high-power diode lasers*, Proc. SPIE, Semiconductor Lasers and Laser Dynamics IX, **11356** (2020), pp. 113560W/1–113560W/14.
- [5] M. RADZIUNAS, *Modeling and simulations of broad-area edge-emitting semiconductor devices*, Int. J. High Perform. Comput. Appl., **32** (2018), pp. 512–522.
- [6] M. RADZIUNAS, J. FUHRMANN, A. ZEGHUZI, H.-J. WÜNSCHE, T. KOPRUCKI, C. BREE, H. WENZEL, U. BANDELOW, *Efficient coupling of dynamic electro-optical and heat-transport models for high-power broad-area semiconductor lasers*, Opt. Quantum Electron., **51** (2019), pp. 69/1–69/10.

1.3 Pressure-robust Flow Discretizations on General Polyhedral Meshes

Derk Frerichs, Alexander Linke, and Christian Merdon

Computational fluid dynamics and quality meshes

Computational fluid dynamics (CFD) is a key technology of our modern society: It is of fundamental economic importance in weather forecasts for agriculture, air transportation, and emergency management, and can give substantial theoretical insight in various scientific disciplines like medicine, climate research, or astrophysics. Even hot topics like the spread of the Corona virus in aerosols or stability investigations of the gulf stream in relation to climate change are covered. What CFD simulations have in common is that they are based on a translation process: Physics describes the motion of fluids, e.g., water or air, by balance laws for their mass and momentum distribution. These laws are formulated in the language of mathematics, leading to the famous *Navier–Stokes equations*, which has continued to trigger challenging research questions since their discovery in the early nineteenth century. And finally, CFD translates these equations by a process called *discretization* into a language that is understood by modern computers. Like any translation process, also *discretization* is error-prone. And what makes the discretization even more challenging is that a reduction of the complexity, i.e., a *compression of information*, of the original problem is needed in order to make simulations computationally feasible in practice. In particular, a lack of *pressure-robustness* as discussed in this contribution can be a very important potential error source during this compression of information.

A starting point for the discretization of any CFD simulation is the availability of a *mesh*. A mesh serves several purposes. Basically, it delivers a partition called *triangulation* of the flow domain of interest, e.g., the outer space of an airplane. In every *control volume* of the mesh, a certain kind of *discrete physics* has to hold, which approximates the original balance laws for the mass and momentum distribution in the fluid. These control volumes are key for the simulation: On the one hand, the more control volumes are spent in the mesh, the more accurate the simulation results are. On the other hand, more control volumes mean more computing time and memory, hence, more electricity and money. But not only the pure number of control volumes, also the shape of the control volumes may help to approximate the physics of the flow. Thus, the availability of *quality meshes* is fundamental for CFD. Such quality meshes allow for appropriate unstructured, adaptive and anisotropic control volumes delivering an appropriate *compression of information*.

In the past, numerical mathematics required certain assumptions on the structure of the underlying mesh: Meshes should be built from simple geometrical objects like tetrahedra or hexahedra in three space dimensions, resp. triangle or quadrilaterals in two space dimensions, facilitating the algorithmic construction and the theoretical investigation of CFD considerably. In recent years, these assumptions have been questioned, though. Instead, *polyhedral meshes* have been proposed, where the flow domain of interest is decomposed into a partition of polyhedra in 3D, resp., general polygons in 2D, which has a great potential to simplify quality mesh generation; see Figures 1–2 for examples.

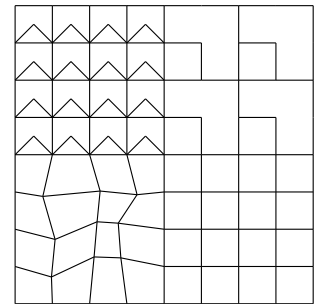

Fig. 1: A square divided into various convex and non-convex polygons with hanging nodes showing the flexibility of polygonal meshes

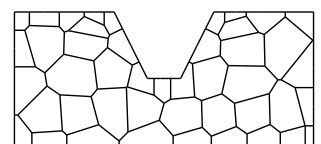

Fig. 2: A Voronoi–Delaunay mesh as used, e.g., in WIAS electrochemistry simulations

Indeed, *polyhedral meshes* facilitate:

- efficient local *mesh refinement*, wherever the physics of the flow locally requires a higher resolution, since *hanging nodes* can be incorporated naturally;
- anisotropic meshes, since anisotropic prismatic control volumes for challenging multiscale phenomena — like the resolution of boundary layers — are allowed;
- multi-physics, i.e., coupling with simulators for other subprocesses with specific mesh requirements is simplified, e.g., with WIAS electrochemistry finite volume solvers on Voronoi–Delau­nay meshes.

However, a major challenge still remains: The *translation process of discretization* for challenging flow problems is much more error-prone on polyhedral and quality meshes than on simple (structured) grids. Especially, for incompressible flow problems recent WIAS research has recognized that only so-called *pressure-robust* flow solvers can be accurate and efficient in general. Thus, this article describes recent progress on the construction of *pressure-robust* flow solvers for *polyhedral grids*.

The incompressible Navier–Stokes equations

CFD as described above consists in the approximate solution of the Navier–Stokes equations (NSE). Mathematically, they form a challenging system of *partial differential equations*, whose solutions, i.e., *the output* of the simulation, are whole functions that model the mass density ρ of the fluid and the velocity distribution in the fluid \mathbf{u} . Since the physical quantities ρ and \mathbf{u} depend on time and space, these functions depend actually on four variables: the time t and the position in space x , y , and z . It is important here to mention that the velocity $\mathbf{u} = (u, v, w)$ is represented as a *vector* of velocities, where u models the velocity of the fluid in x -direction at any point in the domain at any given time t , and v and w model the velocities in y - and z -direction.

Physically, the Navier–Stokes equations are a model that is based on classical Newtonian physics and a few simplifying assumptions valid for many relevant flows. These simplifications allow for a certain *compression of information* as mentioned above: i) in the absence of sources and sinks, *mass is conserved*, and ii) *momentum* changes only by the action of forces. Especially, the Navier–Stokes equations incorporate the *pressure gradient* as a driving force of the fluid and the *friction* force, which tends to decelerate and to homogenize the fluid velocity distribution as a whole. As a rule of thumb, high speed flows, so-called *high Reynolds number flows*, where the friction forces are negligible in large parts of the flow domain, are more difficult to simulate than low-speed flows, where comparably stronger friction forces simplify the simulations.

In the past, research at WIAS has focused on fluid flow in liquids as opposed to fluid flow in gases. Fluid flow in liquids is one — and not the only one — extreme case in fluid mechanics: Such flows are called *incompressible*, since the density of a liquid is practically independent of the pressure. Therefore, the balance law of *mass conservation* for the fluid mass *degenerates* to a *geometric constraint* for the velocity field: The velocity field \mathbf{u} is *divergence-free*, i.e., at every time t , what flows into an arbitrary control volume has to flow out of the control volume, elsewhere. This geometric constraint is very strong and has some important consequences. Here, it matters most that the incompressible Navier–Stokes equations are truly vector-valued. Neither do they make much sense in a one-dimensional setting — under reasonable boundary conditions, the only one-dimensional,

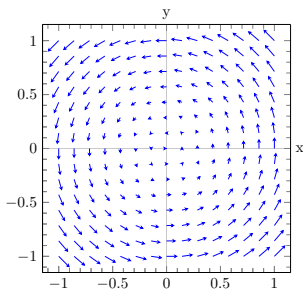

Fig. 3: A divergence-free vector field. Thus, the streamlines of the flow field, indicating the path a fluid parcel will take, are closed loops.

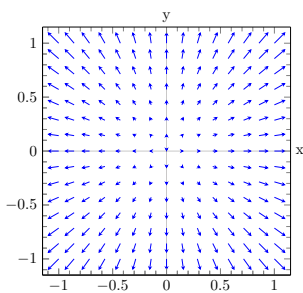

Fig. 4: A gradient vector field. All streamlines start in the origin of the plot; hence, it is non-divergence-free.

divergence-free velocity field is $\mathbf{u} = \mathbf{0}$, nor is it reasonable to decouple the equations for the velocity $\mathbf{u} = (u, v, w)$ into three, separate *scalar* equations for the velocity components u , v , and w .

Some history and WIAS research on pressure-robustness

According to the Helmholtz–Hodge decomposition, all the various forces of the vector-valued incompressible Navier–Stokes equations like the pressure gradient, the viscous forces, and the material derivative can each be split into sums of only two basic type of forces: *divergence-free forces* (closed streamlines as depicted in Figure 3) and *gradient field forces* (streamlines start and end in sources and sinks or at the boundary of the flow domain as shown in Figure 4), which is a remarkable difference to the one-dimensional case, where every force is a gradient, according to the fundamental theorem of calculus. It holds an important orthogonality property: Divergence-free vector fields \mathbf{w} whose streamlines do not leave the flow domain and arbitrary gradient fields $\nabla\phi$ are perpendicular in the following sense:

$$\int \nabla\phi \cdot \mathbf{w} \, dx = 0. \quad (1)$$

The WIAS research on *pressure-robustness* is essentially based on an improved understanding of how the orthogonality relation (1) can be exploited in a CFD algorithm. The term pressure-robustness indicates that the role of the pressure gradient is very special in the incompressible NSE: Only the divergence-free parts of forces like the friction force and the material derivative drive the flow; the gradient field parts of forces in the Navier–Stokes momentum balance are always balanced completely by the pressure gradient, which instantaneously adapts itself all the time for this purpose. This strange behavior of the pressure gradient is due to the degeneracy introduced by the divergence constraint.

Physically, this behavior leads to strong and complicated pressure gradients in fast and challenging vortex-dominated, e.g., hurricane-like, flows at high Reynolds numbers, since the centrifugal force, i.e., the nonlinear material derivative, in a rotating flow is nearly completely balanced by the pressure gradient. Recent WIAS research confirmed that *pressure-robustness* allows for more accurate simulation of such vortex-dominated flows at high Reynolds numbers [5].

Furthermore, the notion of *pressure-robustness* emanates from an improved understanding of the classical *theory of mixed methods* from the 1970ies, which is commonly viewed as a complete theory. This theory allows to construct CFD algorithms for the incompressible Navier–Stokes equations that converge to the exact flow solution if the mesh gets finer and finer. It proposes to relax the cumbersome divergence constraint in order to facilitate the construction of CFD algorithms. To this end, it introduces *discretely divergence-free* vector fields, for which (1) only holds in a certain *discrete sense*, i.e., not for arbitrary smooth ϕ . Unfortunately, this relaxation causes a lack of *pressure-robustness*, resulting in large discretization errors in case of high Reynolds number flows.

In a sense, the numerical analysis of partial differential equations since the 1970ies can be understood as the history of attempts to construct CFD algorithms that have less and less unnecessary constraints. On the one hand, these attempts concern the meshes, where first simplicial and hex-

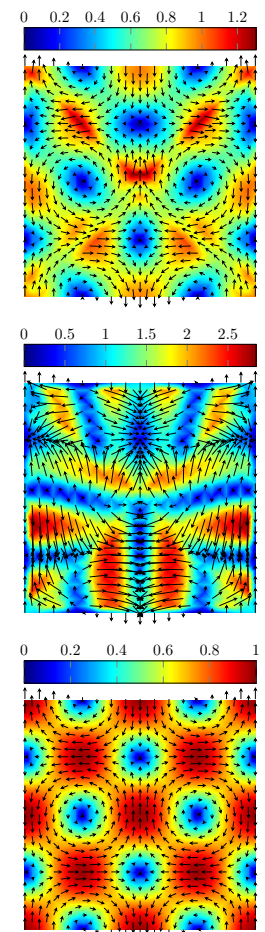

Fig. 5: Velocity fields and their absolute values for a planar lattice flow for $\nu = 10^{-4}$ at time $t = 1$ (transient Stokes equations with exact convection term) calculated with different methods on the same mesh. The classical Taylor–Hood (top, 4771 unknowns) and Bernardi–Raugel (middle, 3682 unknowns) methods show large errors, whereas the pressure-robust Bernardi–Raugel method (bottom, 3682 unknowns) resolves the velocity better.

ahedral meshes were used and nowadays polyhedral meshes are exploited. On the other hand, they concern different kinds of continuity and differentiability constraints for the ansatz and test functions used in a CFD algorithm (H^1 -conforming finite elements, nonconforming finite element schemes, L^2 -conforming Discontinuous Galerkin and finite volume schemes, ...).

In this context, past WIAS research on CFD algorithms on simplicial meshes has demonstrated that the sophisticated and efficient use of so-called $\mathbf{H}(\text{div})$ -conforming finite element schemes allows to fulfill the orthogonality relation (1) exactly, leading to accurate simulation results for time-dependent vortex-dominated high Reynolds number flows [5]. At WIAS, researchers have revealed that pressure-robustness comes from divergence-free and $\mathbf{H}(\text{div})$ -conforming discrete test functions, and not from trial functions [6].

As an outcome, novel pressure-robust low-order schemes like the pressure-robustly modified first-order Bernardi–Raugel scheme can be competitive, or on coarse unstructured meshes even superior, to higher-order schemes like a second-order Taylor–Hood method. An illustration with a time-dependent planar lattice flow $\mathbf{u}(x, y, t) = e^{-8\pi^2 \nu t} [\sin(2\pi x) \sin(2\pi y), \cos(2\pi x) \cos(2\pi y)]$ simulated in the time interval $(0, 1)$ is depicted in Figure 5. This illustration indicates that schemes of (formal) higher order are not enough for an efficient and accurate CFD simulation. Likewise, physical fidelity like pressure-robustness is important for the *translation process of discretization*.

In search for more flexible CFD algorithms, the extension of pressure-robust schemes to polyhedral meshes by exploiting $\mathbf{H}(\text{div})$ conformity has naturally emerged as a research topic.

Pressure-robustness on polyhedral meshes

Methods allowing for polyhedral and polygonal meshes that were drawing enormous attention in the last decade are *hybrid high-order methods* (HHO) and *virtual element methods* (VEMs), besides, e.g., *discontinuous Galerkin methods*, *extended finite element methods*, or *mimetic finite difference methods*. HHO and VEMs work on general polyhedral meshes, but also give the possibility to respect physically relevant properties such as mass conservation.

In the case of VEMs, the divergence constraint mentioned above can be satisfied *exactly* and not only discretely by the design of the ansatz functions in the underlying discrete velocity and pressure space. However, here not only polynomials, but also other non-polynomial basis functions in the velocity space are required. Those basis functions are only defined implicitly, which is why the method is called *virtual* and, hence, have to be treated with care during the design of the discrete equations.

In general, exactly divergence-free methods are also pressure-robust since exactly divergence-free test functions are orthogonal in the sense of (1) to the gradient part of the force. However, this is not the case for the classical VEM, since the virtual test functions need to be projected to suitable polynomial functions that can be evaluated everywhere. Unfortunately, the *classically used* L^2 *best-approximation* does not preserve the divergence, i.e., the projection and the gradient part of the force are not orthogonal in the sense of (1). Therefore, gradient forces in the momentum balance might have a possibly enormous impact on the approximation of the velocity.

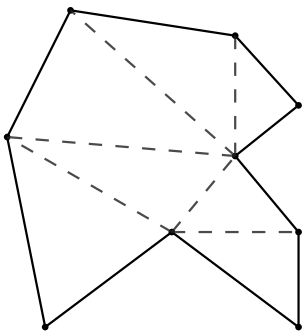

Fig. 6: A polygon (solid lines) and a possible subtriangulation (dashed lines)

To repair the lack of pressure-robustness for the VEM in the spirit of the WIAS approach, another projection has to be used that preserves the divergence. This new and carefully designed *pressure-robust projection* is based on a subtriangulation of the polygons as in Figure 6, and thereon uses well-established ideas of $\mathbf{H}(\text{div})$ -conforming interpolations. It ensures the continuity of the normal flux along the triangle boundaries and, hence, the divergence of the function is preserved, but now can be evaluated pointwise everywhere [4]. The superiority of the new pressure-robust variant compared to the classical VEM can also be seen in Figure 7 in practice for a high Reynolds number flow.

It can be noted that the subtriangulation is used only locally and that the total number of degrees of freedom stays the same. To conclude, this new *pressure-robust* VEM benefits from less computational cost and more flexibility due to polygonal meshes compared to simplicial methods on the corresponding subtriangulations, and reduces the computational cost dramatically in case of strong gradient field forces or high Reynolds number flows compared to the classical VEM.

Outlook

Future research at WIAS on pressure-robust schemes has the following three main goals:

A first goal is to tap the full potential of pressure-robust methods on quality meshes. This goal concerns multi-physics and multi-scale real-world applications as in Czochralski crystal growth and in electro- or magneto-hydrodynamics. And it concerns the construction of CFD algorithms that deliver provably robust and accurate results on anisotropic three-dimensional meshes. First steps towards this goal for simplicial three-dimensional meshes can be found in [3].

A second goal is the construction of novel convection stabilizations for high Reynolds number flows that do not interfere with pressure-robustness. As a first result, the recent WIAS preprint [1] constructs the first \mathbf{H}^1 -conforming, convection-stabilized (LBB-stable) mixed method for the incompressible Oseen model problem that delivers provably optimal velocity convergence rates. Pressure-robustness is decisive to obtain the result.

Third, pressure-robustness extends nicely to novel well-balanced schemes for the compressible Navier–Stokes equations, where dominant gradient-field forces may also excite numerical errors at low Mach numbers [2]. In the future, WIAS research will investigate the case of compressible high Reynolds number flows at low — up to extremely low — Mach numbers.

References

- [1] N. AHMED, G. BARRENECHEA, E. BURMAN, J. GUZMÁN, A. LINKE, C. MERDON, *A pressure-robust discretization of Oseen’s equation using stabilization in the vorticity equation*, WIAS Preprint no. 2740, 2020.
- [2] M. AKBAS, T. GALLOUËT, A. GASSMANN, A. LINKE, C. MERDON, *A gradient-robust well-balanced scheme for the compressible isothermal Stokes problem*, *Comput. Methods Appl. Mech. Engrg.*, **367** (2020), 113069/1–113069/25.

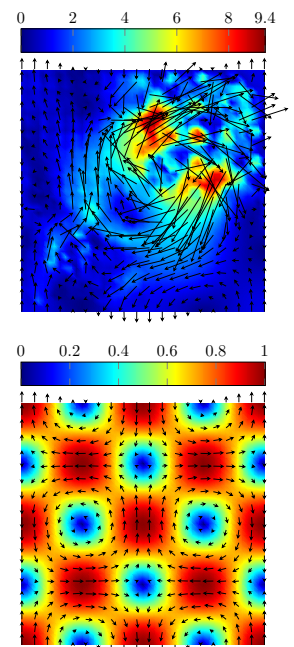

Fig. 7: Velocity fields and their absolute values of the same velocity as in Figure 5 at fixed time $t = 0$ and $\nu = 10^{-4}$ (steady Stokes with exact convection term and exact time derivative) computed by different VEMs with 3426 unknowns. The classical VEM (top) shows large errors, whereas the pressure-robust VEM (bottom) resolves the velocity better.

- [3] T. APEL, V. KEMPF, A. LINKE, C. MERDON, *A nonconforming pressure-robust finite element method for the Stokes equations on anisotropic meshes*, WIAS Preprint no. 2702, 2020, appeared online in: IMA J. Numer. Anal., <https://doi.org/10.1093/imanum/draa097>.
- [4] D. FRERICHS, C. MERDON, *Divergence-preserving reconstructions on polygons and a really pressure-robust virtual element method for the Stokes problem*, WIAS Preprint no. 2683, 2020, appeared online in: IMA J. Numer. Anal., <https://doi.org/10.1093/imanum/draa073>.
- [5] N. GAUGER, A. LINKE, P. SCHRÖDER, *On high-order pressure-robust space discretisations, their advantages for incompressible high Reynolds number generalised Beltrami flows and beyond*, SMAI J. Comput. Math., **5** (2019), pp. 89–129.
- [6] V. JOHN, A. LINKE, C. MERDON, M. NEILAN, L. REBHOLZ, *On the divergence constraint in mixed finite element methods for incompressible flows*, SIAM Review, **59** (2017), pp. 492–544.

1.4 Learning-enriched Differential Equation Models in Optimal Control and Inverse Problems

Guozhi Dong, Michael Hintermüller, and Kostas Papafitsoros

Differential equations, ordinary (ODEs) or partial (PDEs), that is, equations that involve functions and their (partial) derivatives, have been essential tools in many fields of science. They describe the dynamics of the physical world phenomena allowing scientists to get useful insights and make predictions. Very often in applications, it is desirable to focus on specific constituents of the differential equations, for instance, some *parameters* or otherwise called *controls*, that significantly affect how the solution will look like. This need leads to the widely applicable field of *optimal control of differential equations*, where one is seeking for suitable values of these parameters that result in the solution being close to some desirable *state*, e.g., a specific temperature distribution in a room or a specific configuration of a fluid flow. In certain medical applications, these parameters can be some tissue-specific biophysical variables, whose precise value can tell clinicians more about the nature of the tissue, e.g., tumor vs. healthy tissue. Applied mathematicians play a vital role in developing techniques that facilitate these diagnoses. A first key step is to identify as precisely as possible the differential equations related to a given imaging technique whose solutions depend on these parameters. By obtaining measured data that are related to these solutions and correspond to a specific small tissue area, one is able to make a link to some specific biophysical parameter values, and achieve a precise classification of that tissue area. This workflow is done, for instance, in *quantitative magnetic resonance imaging* (MRI); see Figure 1, [4], and the corresponding Scientific Highlights article of the Annual Research Report 2019 of the Weierstrass Institute.

However, very often a differential equation is merely a simplification of a far more complex ground-truth physical process. This physical process can be unknown or too complicated to be precisely modeled. Nevertheless, experimental data can provide some glimpse into the true process itself. One can achieve that, for instance, by considering a family of the differential equations parameters, the *input data*, and experimentally measuring the response of the system, the *output data*, that corresponds to each one of these parameters. It is then desirable to have a tool — a *learned map* — that generalizes this input-output relation to input data that have not been used in this experiment and eventually approximates the physical process. With regard to the optimal control problems, this learned map will substitute the *control-to-state* map. It turns out that this versatile learning from input-output data can be realized via *artificial neural networks* (ANNs). The use of ANNs and the general field of *deep learning* — one of the cores of *artificial intelligence* (AI) — is nowadays ubiquitous. Their remarkable versatility and good approximation properties that are the result of being trained in a set of data, generalizing well in “unseen” data, have made them a powerful tool essentially in any area that involves some type of data classification and interpolation.

There has, therefore, been a need for the introduction, analysis, and application of versatile data-driven frameworks for learning totally or partially unknown physical models via ANNs. This was recently realized in [1] within the EF3 project “Direct reconstruction of biophysical parameters using dictionary learning and robust regularization” in the frame of MATH+, the Berlin Mathematics Re-

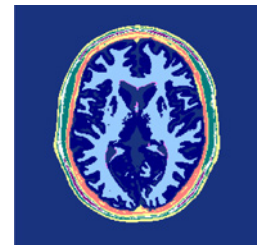

Fig. 1: Quantitative imaging techniques aim to measure precise values of biophysical quantities of fixed units associated to different types of tissues (here color-coded)

MATH+



search Center, which is a cross-institutional and interdisciplinary Cluster of Excellence. ANNs were employed either to learn some unknown nonlinearity in physical models or to represent the complex parameter-to-solution maps of differential equations and subsequently be embedded into optimal control problems. For example in the case of qMRI, the dynamics that map certain tissue-dependent biophysical parameters to the acquired signal, are learned and incorporated into the reconstruction process, yielding more accurate values for the tissue parameter maps with the obvious benefits for clinicians and patients.

As it is a case for any new mathematical framework, it needs to be shown to be mathematically sound and viable. Important questions arise, such as in what degree the approximation quality of a given ANN (stemming from the quantity and quality of the available data) affects the final solution of the optimal control problem. It is also vital to design and develop robust numerical methods for the solution of these learning-informed differential equations and their corresponding optimal control problems. The recent work [1] also addressed these challenges and showed the versatility of the framework in key applications, such as qMRI and the modeling of phase transitions in fluids.

Deep learning and artificial neural networks in brief

Mathematically, a neural network is a function $\mathcal{N} : \mathbb{R}^r \rightarrow \mathbb{R}^s$, with a feed-forward architecture, in the sense that the input is successively propagated into L layers. Every layer consists of a series of *neurons* that perform weighted averages of their inputs that have been fed from the neurons of the previous layer. An activation function σ then decides if the output of each neuron will be passed to the neurons of the next layer, by assigning relatively large values to it. For a more precise example, a standard feed-forward ANN with one hidden layer has the following form:

$$\mathcal{N}(x) = W_0 \sigma(W_1 x + b_1) + b_0, \quad x \in \mathbb{R}^r, \quad (1)$$

where $W_1 \in \mathbb{R}^{l \times r}$, $W_0 \in \mathbb{R}^{s \times l}$ are weight matrices and $b_1 \in \mathbb{R}^l$, $b_0 \in \mathbb{R}^s$ are bias vectors. In that case, we say that the hidden layer has l neurons. A visual example of a 4-hidden layer network is shown in Figure 2, with the neurons in hidden layers depicted as blue nodes. The activation function $\sigma : \mathbb{R} \rightarrow \mathbb{R}$ is some nonlinear map that acts component-wise on a vector in \mathbb{R}^l . Popular activation functions are Sigmoid-type functions, e.g., $\sigma(z) = \arctan(z)$, and the rectified linear unit (ReLU), $\sigma(z) = \max(0, z)$,

Given some data pairs $\{(x_i, f_i) \in \mathbb{R}^r \times \mathbb{R}^s, i = 1, \dots, N\}$, one of the main tasks of deep learning is to identify suitable choices for weight matrices and bias vectors, collectively denoted by θ , such that the corresponding neural network \mathcal{N}_θ satisfies $\mathcal{N}_\theta(x_i) \simeq f_i, i = 1, \dots, N$. In other words, the target is for \mathcal{N}_θ to *learn* a map that corresponds to the input-output data pairs. This learning is typically achieved via the so-called *supervised learning approach*, essentially by solving a minimization problem (*network training*) with respect to θ .

The success of deep learning in several applications is mainly due to the fact that, given enough training data, the resulting parameters θ^* lead to a network \mathcal{N}_{θ^*} that tends to behave well also in other points outside the training set, that is, they have good approximation and interpolation capabilities. Mathematically, this fact is also corroborated by the *universal approximation theorem* for

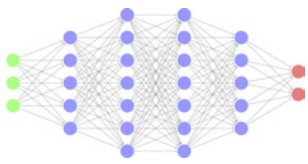

Fig. 2: Visual example of a 4-hidden layer network

neural networks [3], which states that if the activation function σ is a continuous non-polynomial function, then every family of neural network functions of a fixed number of layers is dense to the set of continuous functions $C(\mathbb{R}^r, \mathbb{R}^s)$, in the topology of uniform convergence in compact sets.

Main framework of learning-informed optimal control

Inspired by key applications on optimization models with physical laws constraints, such as quantitative magnetic resonance imaging (qMRI), a versatile data-driven framework was proposed and mathematically analyzed in [1]. The starting point is a general optimal control problem of the form

$$\begin{aligned} & \underset{(y,u)}{\text{minimize}} && \frac{1}{2} \|Ay - g\|_H^2 + \frac{\alpha}{2} \|u\|_U^2, && \text{over } (y, u) \in (Y \times U), \\ & \text{subject to} && e(y, u) = 0, && \text{and } u \in \mathcal{C}_{ad}. \end{aligned} \tag{2}$$

Here, Y, U are some appropriate function spaces, $\alpha > 0$, \mathcal{C}_{ad} is a constraint set for the control u , A is a linear operator — for instance, in the case of inverse problems, it can be regarded as the forward operator of the problem —, and g denotes some given data. The term of focus in (2) is the equation $e(y, u) = 0$, a differential equation describing a physical process, with y being the solution variable (state). Assuming uniqueness of solutions for (2), we write $y = \Pi(u)$ to define the well-defined control-to-state map. We focus on the case where the precise form of the physical process e is unknown, (i) either as a whole or (ii) with respect to a specific constituent. For the latter, consider, for example, the following semilinear partial differential equation:

$$-\Delta y + f(x, y) = u, \quad \text{in } \Omega \subseteq \mathbb{R}^d, \tag{3}$$

where f is a completely unknown nonlinear function. In that case, any calculation of $y = \Pi(u)$ is out of reach. Nevertheless, given the availability of a data pair set $\{(u_i, y_i) : i = 1, \dots, N\}$, such that $y_i \sim \Pi(u_i)$, one can train a neural network \mathcal{N} and use it to approximate the overall unknown control-to-state map. In the case of (3), the neural network \mathcal{N} aims to approximate only the unknown constituent f arriving in the following *learning-informed* PDE

$$-\Delta y + \mathcal{N}(x, y) = u, \quad \text{in } \Omega, \tag{4}$$

In general, we end up with a learning-informed control-to-state map, denoted by Π_N , that can then be embedded into the optimal control problem. A schematic illustration of this framework is shown in the diagram of Figure 3.

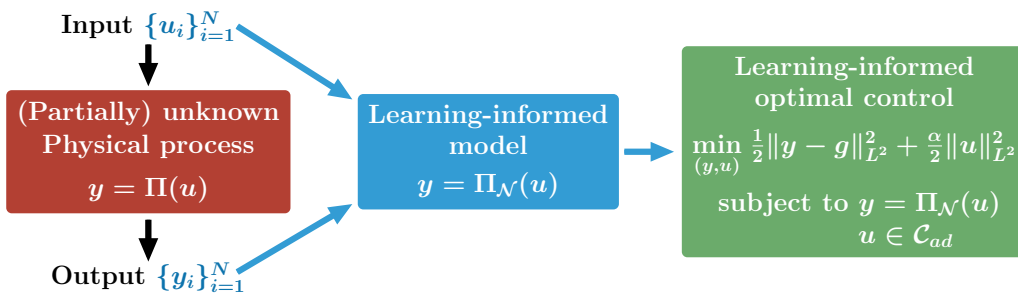

Fig. 3: Schematic illustration of the learning-informed optimal control framework

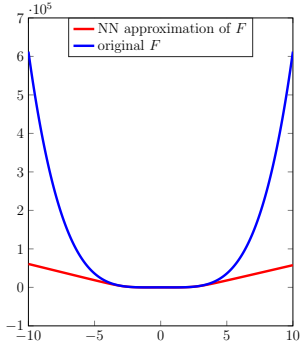

Fig. 4: Approximation of a double-well potential F by a neural network

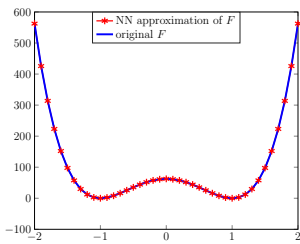
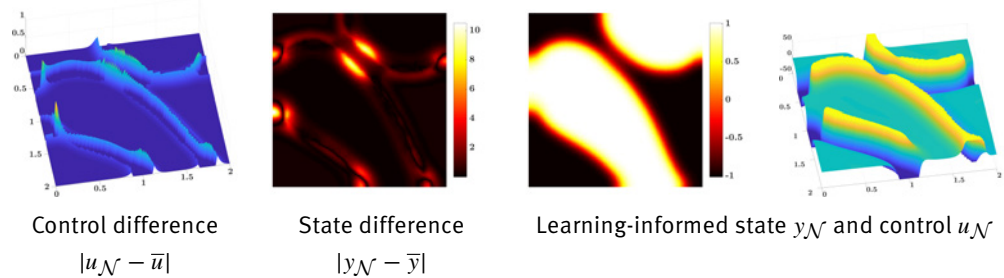

Fig. 5: Detail of Figure 4

Fig. 6: Comparison of the solutions of the learning-informed and ground-truth optimal control problems of the stationary Allen–Cahn equation with the double-well potentials shown in Figure 4



The versatility and applicability of this approach was established in [1] by its validation in two key applications, discussed next.

Optimal control of semilinear partial differential equations. The following general optimal control problem of learning-informed semilinear PDEs was studied in [1]

$$\begin{aligned} & \underset{(y,u)}{\text{minimize}} && \frac{1}{2} \|y - g\|_{L^2(\Omega)}^2 + \frac{\alpha}{2} \|u\|_{L^2(\Omega)}^2, && \text{over } (y, u) \in (H^1(\Omega) \times L^2(\Omega)), \\ & \text{subject to} && -\Delta y + \mathcal{N}(x, y) = u, && \text{in } \Omega, \quad \partial_\nu y = 0 \text{ on } \partial\Omega, \\ & && \text{and } \underline{u}(x) \leq u(x) \leq \bar{u}(x), && \text{for a.e. } x \in \Omega. \end{aligned} \quad (5)$$

Here, $\mathcal{N} : \Omega \times \mathbb{R} \rightarrow \mathbb{R}$ is an ANN that has been sufficiently trained offline in order to approximate an unknown function f in its domain. By formulating the PDE as a first-order optimality condition of a variational problem, existence of solutions to the PDE and further to the optimal control problem were shown. Note that uniqueness for the PDE solution can only be guaranteed if \mathcal{N} is strictly monotone in the second variable, which cannot be reasonably assumed if f is not strictly monotone. In [1], a particular example of a stationary Allen–Cahn equation has been tested as a benchmark problem. There, the nonlinearity f is associated to the derivative of a double-well potential function F , which models the separation of a fluid into two states and whose precise form has traditionally been a matter of modeling choice rather than data driven. In Figures 4 and 5, we show an example where the (derivative of the) ground potential F is learned by a neural network using some local data. Despite the fact that the learned potential looks globally quite different – recalling that the network approximation is good only in a compact set – the important double-well part is well approximated. Indeed, the solution $(y_{\mathcal{N}}, u_{\mathcal{N}})$ of (5) ends up being close to the corresponding solution of the ground-truth model (\bar{y}, \bar{u}) , Figure 6.

Inverse problems on quantitative imaging. It turns out that the task of quantitative MRI, a high-level description of which we have already given, can be formulated as a special case of the general optimal control problem (2). This formulation reads as follows:

$$\begin{aligned} & \underset{(y,u)}{\text{minimize}} && \frac{1}{2} \|P\mathcal{F}(y) - g^\delta\|_{L^2(\Omega)}^2 + \frac{\alpha}{2} \|u\|_{H^1(\Omega)}^2, && \text{over } (y, u) \in [L^2(\Omega)]^{3L} \times [H^1(\Omega)]^3 \\ & \text{s.t.} && \frac{\partial y}{\partial t}(t) = y(t) \times \gamma B(t) - \left(\frac{y_1(t)}{T_2}, \frac{y_2(t)}{T_2}, \frac{y_3(t) - \rho m_e}{T_1} \right), && t = t_1, \dots, t_L, \\ & && \text{and } y(0) = \rho m_0, \quad u := (\rho, T_1, T_2) \in \mathcal{C}_{ad} \subset ([L^\infty(\Omega)]^+)^3. \end{aligned} \quad (6)$$

The goal is to estimate the physical unit values of (T_1, T_2) , the tissue-dependent magnetic relaxation parameters, as well as the proton spin density ρ , with the ultimate target being the classification of a given tissue slice Ω . These biophysical quantities are inserted into the physical dynamics, via the *Bloch equations*, the above ODE system, which describes the evolution of the magnetization y in a tissue volume unit (voxel). In an MRI experiment, subsamples of the Fourier coefficients ($P\mathcal{F}$) of y are measured at specific times t_1, \dots, t_L , resulting in possibly noisy data g^δ . This ill-posed *inverse problem* is modeled in the first line of (6), where additional H^1 regularization is imposed on the unknown parameter maps $T_1, T_2 : \Omega \rightarrow \mathbb{R}$ as well as ρ . If the parameter-to-solution map of the Bloch equations $y = \Pi(T_1, T_2)$ is explicitly known, then it can be embedded into the minimization problem (6), resulting in the following least-squares formulation:

$$\underset{(\rho, T_1, T_2)}{\text{minimize}} \quad \frac{1}{2} \|P\mathcal{F}(\rho \Pi(T_1, T_2)) - g^\delta\|_{L^2(\Omega)}^2, \quad \text{s.t. } (\rho, T_1, T_2) \in \mathcal{C}_{ad}. \quad (7)$$

This approach was introduced in our previous work [2] where (7) was solved with a Levenberg–Marquadt method, giving superior results compared to some of the current state-of-the-art methods in qMRI [4]. Nevertheless, explicit formulas of the Bloch map are only available in certain special choices of the external magnetic field B . However, numerical methods or some elaborate targeted experiments can provide data that facilitate a neural network approximation $\Pi_{\mathcal{N}}$ that can take the role of Π in (7). It was shown in [1] that this learning-informed model can achieve similar results to the “ground-truth” one; see Figure 7. Furthermore, the approach is more flexible and it has the capability to learn some potential perturbation of the initially believed to be accurate model. Finally, there is a significant reduction in the computational load, since a repetitive solution of the exact physical model is avoided.

Mathematical challenges

In terms of the problem (2) and its learned counterpart, many mathematical questions arise. For instance: *Do the learning-informed PDEs admit solutions? Will the optimizers associated to the learning-informed model be close to the one associated to the ground-truth one?* These and similar questions were also addressed in [1]. For instance, focusing on the semilinear PDEs (3) and (4), and under some standard assumption on f (e.g., continuity and certain polynomial growth rates), it was shown that for every $\epsilon > 0$ there exists a neural network $\mathcal{N} \in C^\infty(\mathbb{R}^d \times \mathbb{R})$ such that

$$\sup_{\|y\|_{L^\infty(\Omega)} \leq K} \|f(\cdot, y) - \mathcal{N}(\cdot, y)\|_{L^2(\Omega)} < \epsilon \quad (8)$$

with the corresponding learning-informed PDE (4) admitting a weak solution. The constant $K > 0$ is associated to a uniform bound of the type $\|y\|_{H^1(\Omega)} + \|y\|_{C(\bar{\Omega})} \leq K$ satisfied for every solution of the original PDE uniformly for all controls $u \in \mathcal{C}_{ad}$, with the solutions of the learning-informed PDE satisfying similar estimates. Indeed, we observed that the uniform boundedness of the range of the input and output data (state variable) played a crucial role in these proofs, stemming from the fact that the density of neural networks holds in the topology of uniform convergence on compact sets. Analogous estimates are shown for the control-to-state maps

$$\|\Pi(u) - \Pi_{\mathcal{N}}(u)\|_{L^2(\Omega)} \leq C\epsilon, \quad \text{for all admissible } u \in L^2(\Omega) \quad (9)$$

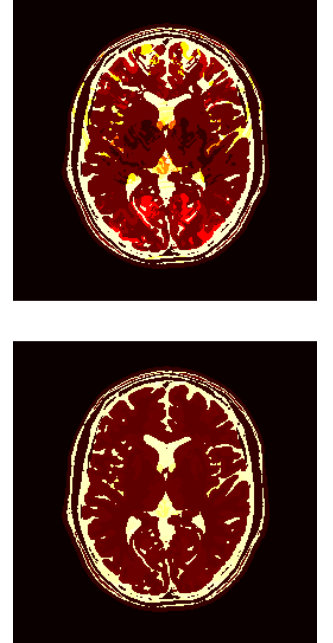

Fig. 7: T2 reconstructed by a dictionary-based method [4] (top) and by the proposed learning-informed method [1] (bottom)

as well as their derivatives.

Regarding the corresponding optimal controls, quantitative convergence results were also proven, showing that under certain conditions, the solution of the learning-informed problem $u_{\mathcal{N}}$ will converge to the solution \bar{u} of (2), with specific rates

$$\|u_{\mathcal{N}} - \bar{u}\|_U \leq C (L_0 \epsilon_1 + \epsilon_1 \epsilon_2 + \epsilon_2 \|Q(\bar{u}) - g\|_H).$$

Here, C is some constant depending on the parameter α , the Lipschitz constant L_0 of the operator $Q := A\Pi$ and its derivative Q' , and ϵ_1 and ϵ_2 are error bounds between Q and $Q_{\mathcal{N}} := A\Pi_{\mathcal{N}}$ and their derivatives, respectively.

Finally, a common numerical algorithmic framework using a sequential quadratic programming (SQP) approach combined with semismooth Newton, was used to tackle both problems (5) and (6), while the numerical algorithm for learning was executed in a separate offline phase before the SQP algorithm.

Conclusions and outlook

We introduced a general optimal control framework that incorporates physical processes that are enriched through data-driven components, and we showed its feasibility in two key applications. This idea combines the power of both traditional mathematical modeling with machine learning methods, and is able to deliver more accurate physical models. The latter can finally serve as data-faithful constraints in optimization tasks. In the future, we expect that such approaches will be used to learn small but systematic deviations from previously well-established physical models. Finally, we note that several mathematical challenges arise from this work. For instance, the use of nonsmooth neural networks, stemming from the incorporation of nonsmooth activation functions, has become prevalent due to certain approximation and trainability advantages. For our set-up, this nonsmoothness poses difficulties in establishing rigorous first-order optimality systems for the learning-informed optimal control problems. Future studies should also focus on incorporating the architecture and the training of the networks into the overall minimization process to further robustify the new technique.

References

- [1] G. DONG, M. HINTERMÜLLER, K. PAPAITSOROS, *Optimization with learning-informed differential equation constraints and its applications*, WIAS Preprint no. 2754, 2020.
- [2] ———, *Quantitative magnetic resonance imaging: From fingerprinting to integrated physics-based models*, SIAM J. Imaging Sci., **12**:2 (2019), pp. 927–971.
- [3] M. LESHNO, V. LIN, A. PINKUS, S. SCHOCKEN, *Multilayer feedforward networks with a nonpolynomial activation function can approximate any function*, Neural Networks, **6**:6 (1993), pp. 861–867.
- [4] D. MA, V. GULANI, N. SEIBERLICH, K. LIU, J. SUNSHINE, J. DUERK, M. GRISWOLD, *Magnetic resonance fingerprinting*, Nature, **495** (2013), pp. 187–192.

1.5 Numerical Methods for Innovative Semiconductor Devices – An Outlook

Patricio Farrell

Introduction

Few discoveries have shaped our modern society like semiconductors. They are the backbone of every electronic device. A world without semiconductors would be one without television, pacemakers, satellites, solar cells, cell phones, air planes, computers – and, by extension, a world without the Internet, social media, and online communication. Semiconductors have made come true what our ancestors would have considered magic. The numbers corroborate this: The global semiconductor industry is huge – world-wide sales topped \$400 billion in 2017 for the first time.

Semiconductors are electronic materials that can act as either conductors (like copper) or insulators (like glass). The conductivity may be controlled, for example, by temperature, intentionally introduced impurities (the *doping*) or even sunlight. This special feature of sometimes resembling metal and sometimes insulators is exploited by practically all electronic components. For this reason it is fundamentally important to model, analyze, and simulate semiconductors correctly. In the past decades, many researchers have worked on models, their analysis and simulations.

How charge carriers (electrons and holes) flow in a semiconductor is modeled by the basic semiconductor equations, also known as the *van Roosbroeck system* [1]. It consists of three nonlinearly coupled partial differential equations (PDEs): one self-consistent equation for the electrostatic potential and two continuity equations for electrons and holes, respectively. The model incorporates two types of movements. Charge carriers drift because the electric field pushes them and diffuse from areas of high to areas of low concentrations.

Since usually no analytic solution is known, one has to solve the continuous PDE system numerically. Any numerical solution shall preserve as many physical properties from the continuous van Roosbroeck system as possible. The finite volume method accomplishes this task in many ways. However, to avoid instabilities (the inevitable impact of rounding errors), a correct approximation of the charge carrier fluxes within the finite volume framework is crucial. The Scharfetter–Gummel flux scheme [2] is well-established for *linear* diffusion.

Unfortunately, in practice, linear diffusion is often a severe oversimplification. In physically challenging situations, such as very low temperatures, highly doped areas, or organic semiconductors (e.g., organic light-emitting diodes (OLEDs)), the diffusion becomes *nonlinear*, meaning that electrons and holes diffuse several orders faster when highly concentrated. Due to this *diffusion enhancement*, it is no longer possible to use the simplifying Boltzmann approximation. Instead, one has to resort to the more complicated Fermi–Dirac statistics. Finding physically correct (in particular, thermodynamically consistent) flux approximations for nonlinear diffusion is of extreme importance to avoid unphysical behavior. Yet several flux approximations proposed in the literature do not consider nonlinear diffusion. Recently, we constructed several such flux approximations

and analyzed how they perform [3, 4, 5, 6]. These methods are needed in several cutting-edge applications, which drive the development of new numerical techniques and computational tools.

Accurate models and physically precise numerical techniques for semiconductor applications – such as the ones described in the preceding paragraph – were the very starting point for the new Leibniz Group LG 5 *Numerical Methods for Innovative Semiconductor Devices*, which was successful within the Leibniz competition. In this article, we give an overview of the group's different thematic key aspects, namely

- innovative applications,
- physical and computational challenges,
- and methodologies.

Applications

Innovative materials, devices and designs. Several promising technological and electronic innovations require to extend the PDE models presented in the introduction:

1. About ten years ago, engineers showed for the first time that low-cost **perovskites** could be used to convert sunlight into electricity. Since then, their efficiency has greatly improved, giving hope to replace or modify (via *tandem solar cells*) less efficient yet widely used silicon-based solar cells soon; see Figure 1 for a simplified perovskite-based solar cell (PSC). Perovskites are not only a novel alternative to silicon in solar cells, but have also many additional useful properties. They can store energy (leading to *photo batteries*, which may generate and store electric charge generated by solar energy), act as magnets or lasers, and are investigated for data storage.

Simulating perovskite solar cells is extremely challenging due to stiffness. Apart from electrons and holes, a third ionic species has to be considered that moves about twelve orders of magnitude more slowly. This means that different time scales are present in the model, which leads to numerical difficulties. While initial attempts have been undertaken to simulate perovskite solar cells, the group plans together with researchers from Imperial College London to combine existing ideas with a Scharfetter–Gummel-type finite volume discretization as well as Fermi–Dirac statistics to account for nonlinear diffusion. Our partners at Helmholtz-Zentrum Berlin will enrich our simulations with experimental data and relevant research questions from applications.

2. **Nanowires** have the potential to greatly reduce the amount of bulk silicon needed in established solar cells, thus enabling cheaper and more resource-efficient solar cells. Useful electronic properties of these thin wires can be controlled via elastic strain. For example, bending nanowires changes the band gap. The Paul Drude Institute for Solid State Electronics (PDI) studies novel techniques to produce bent nanowires. However, deformation-related, piezoelectric, and, in particular, flexoelectric contributions create a complicated potential landscape, which is poorly understood and leads to unexpectedly slow charge carrier transport. In experiments, electrons and holes drift about three orders of magnitude slower than expected. Careful simulations are needed to explain the cause. In addition to charge transport (via the van Roosbroeck system), the strain of the material must also be modeled. Since experiments are often

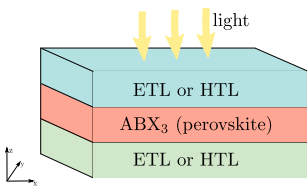

Fig. 1: The perovskite between electron (ETL) and hole transport layers (HTL) consists of two cations A and B as well as anions X

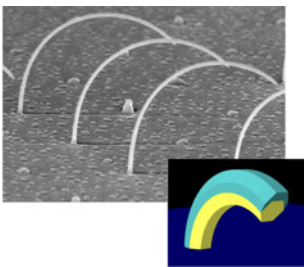

Fig. 2: Scanning electron microscopy (SEM) and schematic image of a nanowire. Source: Lewis et al., *Nano Letters*, vol. 18, pp. 2343–2350, 2018

conducted at very low (cryogenic) temperatures, our techniques for nonlinear diffusion are indispensable.

3. **Semiconductor lasers** are needed in many areas: For example, our collaborators at the Ferdinand-Braun-Institut für Höchstfrequenztechnik study semiconductor-based LiDAR (light detection and ranging) sensors that are expected to improve autonomous driving, since they are accurate, comparatively small, and thus mass-market friendly. Moreover, high precision lasers are needed in quantum metrology and quantum computing. Since building new laser prototypes is costly, it is important to understand for all these cases how a new setup works *before* production. Thus, simulations of semiconductor lasers will not only provide scientific insights, but also help to reduce development costs. To this end, the group will extend the van Roosbroeck model to incorporate more than two charge-carrier species and include additional physical effects (heterostructures, heat transport, and light emission). New physics-preserving numerical methods will be developed to account for these extensions. For efficiency different physical effects need to be resolved on different scales.
4. The **lateral photovoltage scanning** (LPS) method helps to reconstruct tiny fluctuations within a semiconductor crystal such as silicon. This knowledge is important because it provides insight into how the temperature field is distributed during the growth of a semiconductor crystal. Given that silicon melts at 1687K, it is impossible to measure the temperature directly. Therefore, the crystal growth community tries to infer the temperature distribution post mortem from these fluctuations, so-called *striations*, within the crystal. The idea is that within an inhomogeneous material a laser hitting the surface of a crystal sample will generate a voltage that can be measured. After scanning the sample at various laser spot positions, one may use the data to predict the distribution of the fluctuations without having to slice and thus destroy the expensive crystal. The LPS setup is shown in Figure 4.

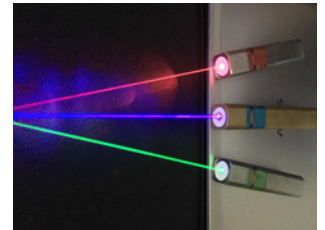

Fig. 3: Different lasers.
Source: Pang Kakit (CC BY-SA 3.0)

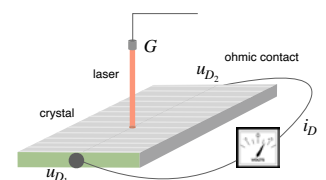

Fig. 4: The lateral photovoltage scanner

Mathematical, physical and computational challenges

In summary, these innovative applications call for several extensions of the van Roosbroeck system on many different levels that the group will be focusing on:

- Diverse **additional physical effects** (such as heat transport, elastic strain, and light emission) will be modeled consistently, investigated numerically and simulated efficiently.
- New types of charge carriers, such as heavy holes or ions, which may move at a considerably slower speed than electrons and holes, will be modeled and incorporated in a simulation tool (**multispecies aspect**).
- Different spatial resolutions for different physical effects (**multiscale aspect**) as well as layers of various types of materials will be considered (**heterostructures**).
- We allow that some parameters in the original PDE model, e.g., the doping, are not known a priori, changing the character of the original model entirely (**inverse problem**).

To advance these applications, mathematical, numerical, and computational challenges need to be overcome. We discuss our methodologies with which we want to tackle these challenges in the next section.

Methodologies

Physics preserving numerical methods. For a given application, the corresponding models need to be converted into a language that computers can interpret. This process is called *discretization*, which turns a continuous problem into a discrete one. The discrete problems are associated with a discrete version of the domain (the mesh). *Finite volume methods* have the advantage that for vanishing source terms they preserve electron and hole fluxes discretely from one region to another – just as physics dictates. On the one hand, with a *Voronoi* mesh, they can be used efficiently. On the other hand, they lead to stable discretizations, which means that inevitable rounding errors do not easily corrupt the solution. This fact allows to develop new numerical methods that correctly preserve the physics – also when, in addition to nonlinear diffusion, other physical effects or additional charge carriers cannot be neglected.

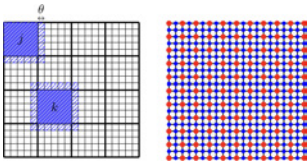

Fig. 5: One type of preconditioning: domain decomposition

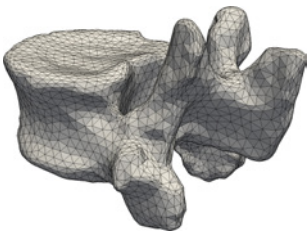

Fig. 6: Anisotropic meshes are problem specific

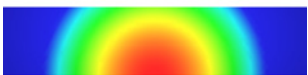

Fig. 7: Simulation of a generation profile created by a laser

Computational efficiency. Once the continuous models are discretized, it is imperative that a simulation program produces a solution as fast as possible. Carefully tailored preconditioning and meshing strategies help to achieve this task.

- Preconditioners help to reduce the computational cost by converting the discretized problem into a more suitable form for numerical computations. They are widely applied in numerical mathematics and indispensable for three-dimensional calculations, where it is no longer possible to employ direct solvers, since they scale highly unfavorably. Instead, one has to use iterative techniques, which adequate preconditioners speed up considerably. Unfortunately, preconditioners always have to be tailored to the specific numerical problem and cannot be used generically.
- To make the computations accurate *and* efficient, the mesh needs to be highly anisotropic, meaning that in areas where the solution varies strongly, we have to use more nodes to resolve the fluctuations. In areas where it varies slowly, we may use fewer nodes to reduce the size of the problem and thus the computational cost. This is especially important for boundary layers and multiscale effects. The aim is to let the computer as far as possible automatically decide where to refine the mesh and where to coarsen it. Despite its practical importance, automatic anisotropic mesh generation is still an open problem.

User-friendly, fast, and open-source simulations. When designing code, one often experiences the conundrum to write fast-running as well as user-friendly code. While established low-level languages like C/C++ are very fast, they are often not easy to use, require considerable experience, and the output is difficult to interpret. Other languages like MATLAB are intuitive and easy to learn, yet do not run very fast in comparison. MATLAB, in particular, is also proprietary software. Hence, an open-source simulation tool, which combines both advantages (fast run time and user-friendliness), is needed. Furthermore, the discrete systems are highly nonlinear. An established way to solve these systems is via Newton's method with parameter embedding. However, deriving the derivatives for the Jacobian takes time and is error-prone. Thus, ways to circumvent setting up the Jacobian are needed to save development time, lines of code, and possible sources of error. We will investigate new software solutions for automatic differentiation that programming languages such as Julia have to offer.

The future

The group has now until December 2024 to work out the details of the presented research program. First results can be found on page 113. It will collaborate with different research groups within WIAS that have already contributed significantly to the mathematics behind semiconductors such as RG 1 *Partial Differential Equations*, RG 2 *Laser Dynamics*, and RG 3 *Numerical Mathematics and Scientific Computing*. Apart from that, LG 5 will work together with Paul Drude Institute for Solid State Electronics, Ferdinand-Braun-Institut für Höchstfrequenztechnik, and Helmholtz-Zentrum Berlin für Materialien und Energie as well as with international partners from the University of Milano-Bicocca, Imperial College, and the University of Strathclyde. Future scientific interests include biosensors and physics-informed data-driven methods.

References

- [1] W. VAN ROOSBROECK, *Theory of the flow of electrons and holes in germanium and other semiconductors*, Bell System Tech. J., **29**:4 (1950), pp. 560–607.
- [2] D. SCHARFETTER, H. GUMMEL, *Large-signal analysis of a silicon read diode oscillator*, IEEE Trans. Electron Devices, **16**:1 (1969), pp. 64–77.
- [3] P. FARRELL, T. KOPRUCKI, J. FUHRMANN, *Computational and analytical comparison of flux discretizations for the semiconductor device equations beyond Boltzmann statistics*, J. Comput. Phys., **346** (2017), pp. 497–513.
- [4] P. FARRELL, D. PESCHKA, *Nonlinear diffusion, boundary layers and nonsmoothness: Analysis of challenges in drift-diffusion semiconductor simulations*, Comput. Math. Appl., **78** (2019), pp. 3731–3747.
- [5] M. PATRIARCA, P. FARRELL, J. FUHRMANN, T. KOPRUCKI, *Highly accurate quadrature-based Scharfetter–Gummel schemes for charge transport in degenerate semiconductors*, Comput. Phys. Comm., **235** (2018), pp. 40–49.
- [6] D. ABDEL, P. FARRELL, J. FUHRMANN, *Assessing the quality of the excess chemical potential flux scheme for degenerate semiconductor device simulation*, Opt. Quantum Electron., **53** (2021), pp. 163/1–163/10, Open Access: <https://link.springer.com/article/10.1007/s11082-021-02803-4>.

1.6 Thematic Einstein Semester “Energy-Based Mathematical Methods for Reactive Multiphase Flows”

Matthias Liero, Alexander Mielke, Dirk Peschka, Marita Thomas, and Barbara Wagner

Berlin Mathematics Research Center

MATH+

Research thrives on scientific exchange and discussion. To foster communication between different groups of mathematicians and to develop new ideas and topics, the Berlin Mathematics Research Center MATH⁺ created *Thematic Einstein Semesters*, funded by the Einstein Foundation Berlin. This program usually runs for one semester and is organized by members of the MATH⁺ faculty, Postdocs, Ph.D. students, as well as external colleagues from mathematics or other fields. The main goal of the Thematic Einstein Semesters is to initiate subsequent activities, such as new research collaborations between seemingly distant mathematical fields, the generation of novel research ideas that provide a basis for a potential new *Emerging Field* within MATH⁺, or an external project proposal such as DFG *Research Training Groups* or projects with industry.

The Thematic Einstein Semester *Energy-Based Mathematical Methods for Reactive Multiphase Flows* in the winter term 2020/2021 is the fourth in the series and planning began with the proposal in February 2019. As the coronavirus pandemic worsened in 2020, the original concept was gradually transformed from an on-site event to a hybrid event, and finally to the following online events:

- Student Compact Course “Variational Methods for Fluids and Solids”, October 12–23, 2020,
- Kick-Off Conference “Energy-Based Mathematical Methods for Reactive Multiphase Flows”, October 26–30, 2020,
- Workshop “Mathematical Analysis for Mechanics (MA4M)”, November 23–25, 2020,
- Weekly Seminar “Energy-Based Mathematical Methods and Thermodynamics”,
- Final Conference “Structures in Evolution – Theory and Applications”, February 23–25, 2021.

Since the early works of Lagrange and Hamilton for classical mechanics and Rayleigh and Helmholtz for dissipative processes, energetic variational methods for fluids and solids have been developed extensively. The relation to underlying microscopic stochastic models was pioneered by Onsager, leading to his celebrated reciprocal relations. However, most systematic developments concerned either purely conservative Hamiltonian systems or purely dissipative gradient systems. In the last two decades, a unification of these two extremes was addressed by developing frameworks for combining both conservative and dissipative dynamics. More recently, these topics evolved into mathematical theories such as GENERIC (*General Equations for Non-Equilibrium Reversible Irreversible Coupling*) and port-Hamiltonian structures.

Over the last decades, different communities have developed own languages and specific mathematical methods that are not always accessible to outsiders. Thus, the central aim of this Thematic Einstein Semester was to bring together scientists from different communities and to develop synergies between the different approaches and to contribute to the structural analysis of complex problems in materials science.

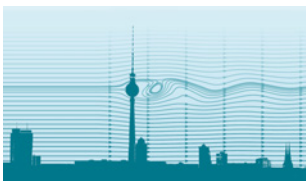

Fig. 1: The Thematic Einstein Semester was jointly organized by Matthias Liero, Volker Mehrmann, Alexander Mielke, Dirk Peschka, Marita Thomas, and Barbara Wagner

Topics and trends of the Thematic Einstein Semester

Applied mathematics in Berlin and especially at the Weierstrass Institute has a long tradition of linking application-oriented modeling with fundamental mathematical research. Mathematical modeling is a cornerstone of applied and interdisciplinary research with scientific and industrial partners and is prominent in the WIAS application areas *Flow and Transport*, *Materials Modeling*, *Nano- and Optoelectronics*, and *Quantitative Biomedicine*. In the Thematic Einstein Semester, we have seen contributions related to applications in thermohydrodynamics, magnetohydrodynamics, electrochemistry, hydrogels, suspensions, and granular media in the context of engineering, biological, physical, and geophysical applications. In particular, for complex coupled systems, the extension to interface thermodynamics was identified as an important research task. Variational modeling and the further development of corresponding mathematical analysis will also enable us in the future to build a bridge for mathematics to new scientific applications in these exciting topics.

The contributions and lectures in the Thematic Einstein Semester showed that the following topics will be most relevant in the context of energetic variational mathematical methods:

- Variational approaches are regarded as advantageous to investigate model hierarchies, scaling limits, and problems with different spatial or temporal scales. While the last point has been treated mathematically rigorously for gradient flows, corresponding results for Hamiltonian, damped Hamiltonian, port-Hamiltonian, and GENERIC systems have yet to be established.
- To put the formal beauty of variational structures into practice, many researchers investigate how to exploit them for rigorous mathematical analysis and how to develop structure-preserving space- and time-discretization schemes for the corresponding partial differential equations (see Figures 2 and 3).
- Control and optimization, inclusion of constraints, parameter identification, and aspects of Big Data are obviously relevant and hot topics in the context of materials modeling.
- While modeling often focuses on the important aspect of consistently coupling physical, chemical, or biological effects, the issue of bulk-interface coupling and the framework for considering open versus closed systems are usually neglected but imperative for realistic materials.

In the following, some WIAS specific aspects of the Einstein Semester are presented.

Energetic variational modeling approaches. The GENERIC framework was introduced by Grmela & Öttinger (1997) to combine reversible (Hamiltonian) dynamics, obtained via a skew-symmetric Poisson operator $\mathbb{L} = -\mathbb{L}^*$ and an energy functional \mathcal{E} , and irreversible (gradient) dynamics, obtained via a symmetric Onsager operator $\mathbb{K} = \mathbb{K}^* \geq 0$ and an entropy functional \mathcal{S} . Denoting by $X \in \mathcal{X}$ the state, the abstract evolution equation for the GENERIC system $(\mathcal{X}, \mathcal{E}, \mathcal{S}, \mathbb{L}, \mathbb{K})$ reads

$$\dot{X} = \mathbb{L}(X)D\mathcal{E}(X) + \mathbb{K}(X)D\mathcal{S}(X).$$

While the skew-symmetric operator induces a Poisson bracket $\{\cdot, \cdot\}_{\mathbb{L}}$, the symmetric and positive (semi-)definite operator induces a gradient structure with $\nabla_{\mathbb{K}}\mathcal{S} = \mathbb{K}D\mathcal{S}$, defining the gradient of \mathcal{S} . The central additional assumptions of the GENERIC framework are the noninteraction conditions $\mathbb{L}D\mathcal{S} \equiv 0$ and $\mathbb{K}D\mathcal{E} \equiv 0$ that imply conservation of total energy and a nonnegative entropy

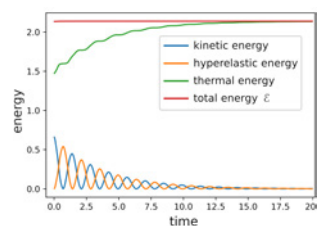
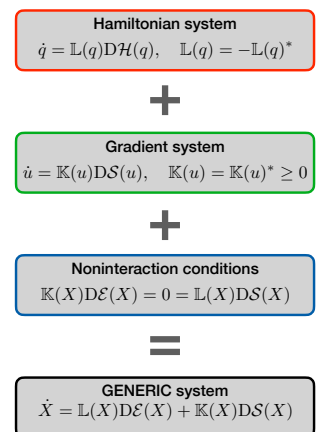

Fig. 2: Evolution of energy $\mathcal{E} = \mathcal{E}_{kin} + \mathcal{E}_{elast} + \mathcal{E}_{therm}$ for a closed thermo-visco-elastic system shows energy conservation and increasing thermal energy over time

production, i.e., $\frac{d}{dt}\mathcal{E}(X(t)) = 0$ and $\frac{d}{dt}\mathcal{S}(X(t)) \geq 0$, as shown in Figure 2. Additional modeling concepts that were discussed during the Einstein Semester are port-Hamiltonian systems, gradient flows, Hamiltonian structures, Lagrangian approaches, and classical nonequilibrium thermodynamics.

Currently, at WIAS the research groups RG 1 *Partial Differential Equations*, RG 3 *Numerical Mathematics and Scientific Computing*, RG 4 *Nonlinear Optimization and Inverse Problems*, RG 7 *Thermodynamic Modeling and Analysis of Phase Transitions*, RG 8 *Nonsmooth Variational Problems and Operator Equations*, and WG 1 *Modeling, Analysis and Scaling Limits for Bulk-Interface Processes* are actively working on coupling continuum mechanics of fluids and solids with the smooth and nonsmooth evolution of state variables such as entropy (thermal effects), concentrations (phase transitions), phase fields (damage or plasticity), and vectors or tensors (anisotropy, electromagnetism). Continuum models coupling thermal effects and elasticity with GENERIC are based on a description using the state $X = (\mathbf{u}, \mathbf{p}, s, z)$ representing displacement \mathbf{u} , linear momentum \mathbf{p} , entropy s , and further variables z to describe inelastic effects. For this one writes the Hamiltonian and entropy of the system as

$$\mathcal{E}(X) = \int_{\Omega} \frac{1}{2\ell} |\mathbf{p}|^2 + U(\mathbf{u}, \nabla \mathbf{u}, s, z) dx, \quad \mathcal{S}(X) = \int_{\Omega} s dx,$$

where the internal energy U features a thermal and a hyperelastic energy contribution, and additional coupling to the internal variable; see Figure 3. Depending on the material system, different choices of the internal energy are possible and can also be derived from the underlying statistical interpretation. In a Lagrangian description, for functionals $\mathcal{F}(X) = \int F dx$ and $\mathcal{G}(X) = \int G dx$ the corresponding Poisson structure can, not always, but often be considered to have the simple form

$$\langle \mathcal{F}, \mathcal{G} \rangle_{\mathbb{L}}(X) = \langle D\mathcal{F}(X), \mathbb{L}(X)D\mathcal{G}(X) \rangle = \int_{\Omega} \sum_{i=1}^d \left(\frac{\delta F}{\delta \mathbf{u}_i} \frac{\delta G}{\delta \mathbf{p}_i} - \frac{\delta G}{\delta \mathbf{u}_i} \frac{\delta F}{\delta \mathbf{p}_i} \right) dx$$

to satisfy the noninteraction condition. Thus, most of the nontrivial structure of coupled multi-physics descriptions for continuum mechanics is incorporated in the noninteraction conditions and in the irreversible operator $\mathbb{K}(X)$. While it is far from obvious how this can be done, in the past it has been well studied how different choices of $\mathbb{K}(X)$ generate mass-action-type reactions, diffusion, heat conduction, internal mechanical dissipation, and corresponding cross-coupling effects. More recent research has shown different ways to add further complexity to the range of GENERIC models studied at WIAS. For example, operators of the form

$$\langle \eta, \mathbb{K}(X)\eta \rangle = \int_{\Omega} a(X)\nabla \eta \cdot \nabla \eta dx + \int_{\Gamma} b(X)|\eta|^2 ds$$

give rise to certain force balances on interfaces and similarly at contact lines. In order to explain normal pressures observed in mixtures of liquids with solid particles (suspensions), the Onsager operator \mathbb{K} is replaced with the subdifferential of the nonsmooth dual dissipation potential

$$\mathcal{R}^*(X, \eta) = \int_{\Omega} W(X, \eta, \nabla \eta) dx, \quad W(X, y, \mathbf{z}) = \mu(X) |\mathbf{z}|^2 + \gamma(X) |\text{tr}(\mathbf{z})| |\mathbf{z}| + M(X)|y|^2.$$

Similar ideas are currently extended to material systems spanning the whole range from soft matter to living materials, such as for models of hydrogels. The latter have been developed in RG 7

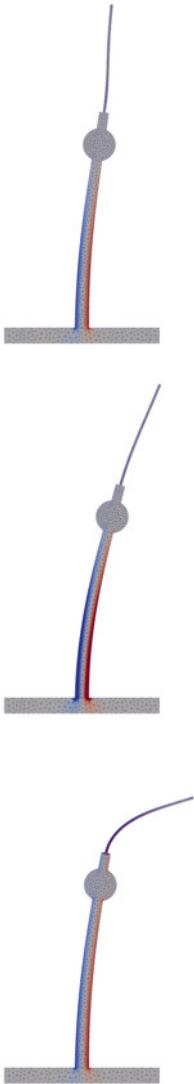

Fig. 3: Evolution of deformation (mesh) and density (shading) using structure-preserving discretization of damped-Hamiltonian visco-elasto-dynamics. The numerical scheme was extended to GENERIC in a student project.

and open the door to a multitude of biomedical applications such as tissue regeneration, or the development of biologically inspired materials. Furthermore, a central topic in cellular biology is mean-field material models that describe fundamental biological processes such as liquid-liquid phase separation to model the formation of subcellular structures, e.g., organelles. In the Einstein Semester, we saw many contributions related to variational modeling of complex material systems.

Multiscale problems and variational methods. Solutions of nonlinear partial differential equations often exhibit oscillations and concentration effects on multiple temporal or spatial scales; see, e.g., Figure 4. Let us consider a family of evolution equations $\dot{u}_\varepsilon = \mathcal{V}_\varepsilon(u_\varepsilon)$, where $\varepsilon > 0$ is a small parameter arising as the ratio between macro- and microscopic scales. A central question is the derivation of effective equations on the macroscale that fully take into account the effects on the microscale such that a limit u_0 of solutions u_ε satisfies the effective model $\dot{u}_0 = \mathcal{V}_0(u_0)$. If the evolution equations additionally have a geometric structure, e.g., via Hamiltonian, gradient, or GENERIC systems, it is natural to ask for a suitable notion of convergence of the systems to an effective limit system, thus providing additional information about the effective equation.

In particular, for generalized gradient systems the evolution is described in terms of two functionals, namely the energy functional \mathcal{E}_ε and the dissipation potential \mathcal{R}_ε . Then, the evolution can be written in the doubly nonlinear form $\partial_{\dot{u}} \mathcal{R}_\varepsilon(u, \dot{u}) + D\mathcal{E}_\varepsilon(u) \ni 0$. However, using the Legendre–Fenchel equivalences and the chain rule $\frac{d}{dt} \mathcal{E}_\varepsilon(u(t)) = \langle D\mathcal{E}_\varepsilon(u(t)), \dot{u}(t) \rangle$, we arrive at an equivalent formulation of the evolution via the so-called *energy-dissipation principle* (EDP)

$$\forall t > 0 : \quad \mathcal{E}_\varepsilon(u_\varepsilon(t)) + \int_0^t \left\{ \mathcal{R}_\varepsilon(u_\varepsilon; \dot{u}_\varepsilon) + \mathcal{R}_\varepsilon^*(u; -D\mathcal{E}_\varepsilon(u_\varepsilon)) \right\} dt = \mathcal{E}_\varepsilon(u_\varepsilon(0)).$$

Since this scalar equation is written entirely in terms of functionals, Γ -convergence can be used. Naively, one would hope that Γ -limits of the functionals give rise to an effective gradient system for the limit problem. While this is true in many examples, there are problems with nontrivial interaction between energy and dissipation. Indeed, Dondl, Frenzel, and Mielke (2019) showed that for wiggly energies of the form $\mathcal{E}_\varepsilon(u) = \Phi(u) + \varepsilon A \cos(u/\varepsilon)$, the microscopic fluctuations in \mathcal{E}_ε “survive” in an effective dissipation potential \mathcal{R}_{eff} that satisfies $\mathcal{R}_{\text{eff}} \neq \Gamma\text{-lim } \mathcal{R}_\varepsilon$; see Figure 5.

Several notions of EDP convergence were introduced to better characterize this behavior: The *simple EDP convergence* demands Γ -convergence of \mathcal{E}_ε and of the dissipation functionals $\mathcal{M}_\varepsilon(u) = \int_0^T \mathcal{R}_\varepsilon(u, \dot{u}) + \mathcal{R}_\varepsilon^*(u, -D\mathcal{E}_\varepsilon(u)) dt$ to \mathcal{E}_0 and \mathcal{M}_0 , where the latter must have the same form $\mathcal{M}_0(u) = \int_0^T \mathcal{R}_{\text{eff}} \oplus \mathcal{R}_{\text{eff}}^* dt$. However, simple EDP convergence is often unsatisfactory as the effective limit \mathcal{R}_{eff} may depend on more than the microscopic behavior of the energy functionals \mathcal{E}_ε that disappears in their macroscopic limit. Thus, the effective energy and dissipation functional are not truly independent of each other. To solve this problem, the notion of *tilted EDP convergence* was introduced, where modified energy functionals $\mathcal{E}_\varepsilon^\eta(u) = \mathcal{E}_\varepsilon(u) - \langle \eta, u \rangle$ and modified total dissipation functionals $\mathcal{M}_\varepsilon^\eta(u) = \int_0^T \mathcal{R}_\varepsilon(u, \dot{u}) + \mathcal{R}_\varepsilon(u, -D\mathcal{E}_\varepsilon(u) + \eta) dt$ with arbitrary “tilts” η are considered. The crucial condition is that the Γ -limit of $\mathcal{M}_\varepsilon^\eta(u)$ is independent of η with an integrand $\mathcal{N}_0(u, \dot{u}, \eta)$, and an effective dual dissipation potential $\mathcal{R}_{\text{eff}}^*(u, \xi) = \mathcal{N}_0(u, 0, \xi + D\mathcal{E}_0(u))$ can be found. However, it turns out that the notion of tilted EDP convergence is too strong and many interesting examples are excluded. This issue is resolved in *contact EDP convergence*, which

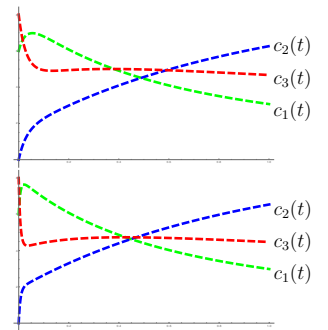

Fig. 4: Solution behavior of a fast-slow reaction system $\dot{c} = \mathbf{R}_{\text{slow}} + \frac{1}{\varepsilon} \mathbf{R}_{\text{fast}}$ for $\varepsilon = 1$ (top) and $\varepsilon = 0.2$ (bottom). Effective evolution is derived via EDP convergence.

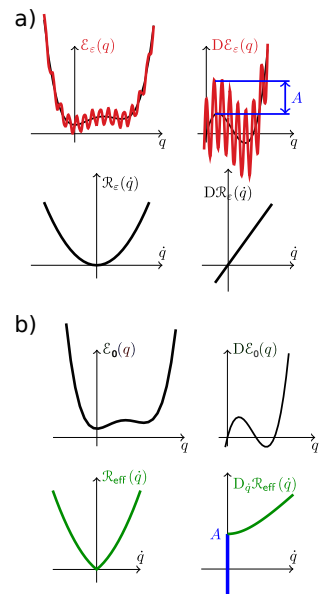

Fig. 5: Derivation of an effective wiggly-energy model. Microscopic fluctuations from energy in (a) survive in effective (nonsmooth) dissipation potential in (b).

requires only that \mathcal{R}_{eff} satisfies

$$\mathcal{R}_{\text{eff}}(u, v) + \mathcal{R}_{\text{eff}}^*(u, \xi) = \langle \xi, v \rangle \quad \Leftrightarrow \quad \mathcal{N}_0(u, v, \xi + \text{D}\mathcal{E}_0(u)) = \langle \xi, v \rangle.$$

The benefit of the intermediate concept of contact-EDP convergence lies in the combination of tilting, which allows the convergence of \mathcal{M}_ε to roam over all of (\dot{u}, ξ) space, and the restriction to the contact set. Thus, the connection between \mathcal{N}_0 and \mathcal{R}_{eff} is reduced to the case of contact, i.e., the kinetic relation $\xi \in \partial_{\dot{u}} \mathcal{R}_{\text{eff}}(u, \dot{u})$. Many interesting multiscale problems in connection to the various notions of EDP convergence were discussed during the Thematic Einstein Semester, ranging from slow-fast reactions to diffusion problems in thin structures to the discrete-to-continuous passage.

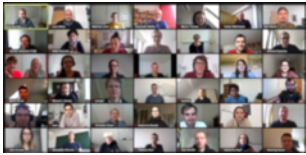

Fig. 6: 40–70 participants joined energetic interactive discussions during Zoom presentations, break-out sessions and round-table discussions

Thematic Einstein Semester: Online. The activities of the Thematic Einstein Semester were organized with different goals and audiences in mind. The focus was on the involvement of students in the semester and the further development of energetic variational mathematical methods in the context of applications. All online events were designed to create plenty of opportunities for interaction. Before the semester, we looked into different platforms to support online conferencing: The key criteria were data protection, user-friendliness, reliability, and scalability. With these aspects in mind, we compared BigBlueButton, Zoom, Jitsi, Remo, and ultimately found Zoom with customized settings the best compromise. We also tested, but then decided against Zoom Webinars, so that participants could better interact with each other. In addition to the public website, we used the platform Zulip for registered participants to distribute up-to-date sensitive information (Zoom links, lecture notes, and recordings) and to initiate further discussions. The platform was used by 40–60 of about 140 registered users on a daily basis during the following main events:

The two-week course *Variational Methods for Fluids and Solids* (October 12–23) was organized in collaboration with the DFG Collaborative Research Center SFB 1114 *Scaling Cascades in Complex Systems* for undergraduate and graduate students interested in mathematical aspects of energetic approaches. These topics were covered in daily mini-courses given by invited external speakers and by the organizers of the program. Longer breaks between lectures allowed students to discuss with the lecturers in break-out rooms. All the lectures were recorded and made available together with lecture notes on Zulip. Of the 109 registered participants (mostly students) from 14 countries, 81 were from Germany, 52 were from Berlin, and 34 were female. About 40–70 people followed the lectures each day.

The *Kick-Off Conference* (October 26–30) targeted experienced researchers and students. Complementing the usual discussion after talks, there were extensive discussions in break-out rooms. As additional elements of an online conference, the program also included round-table discussions, online polls, and poster-style parallel discussions. While the round-table discussions turned out to be driven by experienced researchers, there were many insights to be gained for younger participants. The parallel poster session is a flexible format suited for technical discussions. Most talks of the conference were recorded and made available to participants during the time of the conference. The conference had 148 registered participants from 13 countries, with 40–70 people attending on a daily basis. From these, 96 participants were from Germany, 63 were from Berlin, 31 were female, 36 were students. Parts of the program were in cooperation with the DFG Collaborative Research Center SFB 910 *Control of Self-organizing Nonlinear Systems: Theoretical Methods and Concepts of Application*.



Conclusion and Outlook

The various events and the involvement of the Berlin Collaborative Research Centers, MATH⁺, universities, and research institutes with over 320 local and international participants resulted in an inclusive event with the potential for many new collaborations in applied mathematics and interdisciplinary research. In particular, research on novel materials, scaling limits, bulk-interface coupling, and structure-preserving discretizations could be identified as hot topics. Despite all difficulties caused by the coronavirus, the Thematic Einstein Semester was a great success and contributed to the scientific discourse in these difficult times.

1.7 Stochastic Optimal Control by Reinforced Regression

Christian Bayer, Paul Hager, John G.M. Schoenmakers, and Vladimir Spokoiny

Stochastic optimal control

Stochastic optimal control problems form an important class of stochastic optimization problems that find applications in a wide variety of fields, see [2] for an overview. The general problem can be formulated as follows: How should a decision maker control a system with a stochastic component to maximize the expected reward?

Originally, optimal stochastic control problems were inspired by engineering problems in the continuous control of a dynamic system in the presence of noise. In the last decades, problems in mathematical finance (portfolio optimization, options with variable exercise possibilities) and economics inspired many new developments. Let us also mention the closely connected area of reinforcement learning with a plethora of applications in robotics, data science, and engineering; see [3].

To fix ideas, let us introduce a simple formal setting for stochastic optimal control problems in discrete time and discrete action space. Let $X = (X_j)_{j=0}^J$ denote a *Markov process* modeling the random *environment*. At time $0 \leq j \leq J$, we take an *action* a in some finite *action space* \mathcal{K} , which leads to a *reward* or *cash flow* $H(a, X_j)$, where the *control* Y_j encodes the effect of our previous actions (before time j) on the system (often as a *restriction* on the allowed actions), and X_j denotes the value of the random environment at time j . Indeed, there is an *admissible* subset $K_j(Y_j, X_j) \subset \mathcal{K}$ of the full action space, restricting the choices of the controller. Finally, the control is updated to $Y_{j+1} \equiv \varphi(a, Y_j)$ to reflect the action a taken at time j . The total reward is now the sum of all the individual rewards $\sum_{j=0}^J H(a_j, X_j)$. This framework can easily be generalized to cover more general examples: For instance, the reward H could depend on j and Y_j , too.

Example: Gas storage. The operator of a gas storage facility may try to exploit changes in gas prices by trading gas, ideally by buying at periods of low prices and selling at high prices. In this case, $X = (X_j)_{j=0}^J$ denotes the market price of gas, and the operator may, at any time, decide to either

- sell a volume b of gas from the storage at price bX_j ;
- buy a volume b of gas at price bX_j and store it;

or do nothing. Hence, the action space is given by $\mathcal{K} = \{+1, 0, -1\}$, noting that an action a results in a trade ab . Of course, the operator cannot sell gas if the storage is empty, and cannot buy additional gas if the storage is already completely full. Hence, our decisions are influenced by the fill level of the storage, which is our control Y_j . Given an action a , the control is updated by $Y_{j+1} = \varphi(a, Y_j) = Y_j + ab$, and only actions $a \in \mathcal{K}$ are admissible that lead to $0 \leq Y_{j+1} \leq L$ for some total capacity L of the storage. Finally, the cash flow at time j satisfies $H(a, X_j) \equiv abX_j$.²

²It should be noted that the example contains various idealizations and simplifications. For instance, we assume that the market is perfectly liquid (no transaction costs and no price impact), there is no leakage of pipes, and that the operator only trades in discrete quantities b .

Going back to our general setting, the controller chooses an *admissible strategy* $\mathbf{A} \in \mathcal{A}_0$, $\mathbf{A} = (A_0, \dots, A_J)$ ³. This not only means that $A_j \in K_j(Y_j, X_j)$, $j = 0, \dots, J$, but A_j may (and typically will) depend on the random environment as realized before (and including) time j , as well as on the actions taken before time j , but it may *not* depend on future realizations of the random environment, i.e., on $(X_\ell)_{\ell=j+1}^J$. Indeed, we note that $K_j(Y_j, X_j)$ explicitly depends on Y_j , which depends on the actions (A_0, \dots, A_{j-1}) . All of this is hidden in the notation \mathcal{A}_0 . The actual control problem can now be described as the task to compute

$$v_0^*(Y_0, X_0) := \sup_{\mathbf{A} \in \mathcal{A}_0} \mathbb{E} \left[\sum_{j=0}^J H(A_j, X_j) \right].$$

Dynamic programming

A popular method for solving such problems is based on Bellman's celebrated *dynamic programming*, which simplifies a complicated, dynamic decision problem by splitting it up into many, recursive but simpler sub-problems. Let $v_j^* = v_j^*(Y_j, X_j)$ denote the solution of the corresponding problem *started at time* j , meaning that we consider

$$v_j^*(Y_j, X_j) := \sup_{\mathbf{A}=(A_j, \dots, A_J) \in \mathcal{A}_j} \mathbb{E}_j \left[\sum_{\ell=0}^J H(A_\ell, X_\ell) \right], \quad (1)$$

where \mathbb{E}_j denotes the *expectation, conditional* on the whole history of the system until time j , and \mathcal{A}_j denotes the set of admissible strategies starting from time j – note that \mathcal{A}_j implicitly depends on X_j, Y_j . Given $Y_j = y$ and $X_j = x$, the dynamic programming principle links v_j^* to v_{j+1}^* , by

$$v_j^*(y, x) = \sup_{a \in K_j(y, x)} \left(H(a, x) + \mathbb{E}_j \left[v_{j+1}^*(\varphi(a, y), X_{j+1}) \right] \right). \quad (2)$$

As v_j^* is solution to a simple deterministic optimization problem, we can now solve the optimization problem by backward iteration, starting from $j = J$.

The biggest computational challenge for solving (2) is the computation of the conditional expectation \mathbb{E}_j , which is usually done by *least-squares Monte Carlo regression*. Given a fixed set of basis functions ψ_1, \dots, ψ_K , and given a control value z , we simulate M independent samples $(X_j^{(m)}, X_{j+1}^{(m)})$ from the distribution of (X_j, X_{j+1}) . Then we approximate the conditional expectation in (2) by

$$\mathbb{E}_j \left[v_{j+1}^*(z, X_{j+1}) \right] \approx \sum_{k=1}^K \gamma_k^*(z) \psi_k(X_j), \quad (3)$$

where the coefficients $\gamma_1^*(z), \dots, \gamma_K^*(z)$ are solutions to the least-squares problem

$$\sum_{m=1}^M \left(v_{j+1}^*(z, X_{j+1}^{(m)}) - \sum_{k=1}^K \gamma_k \psi_k(X_j^{(m)}) \right)^2 \rightarrow \min! \quad (4)$$

³We switch to capital letters A to reflect the possible *randomness* of the actions.

Reinforced regression

One problem of the standard regression algorithm is that its performance strongly depends on the choice and the number of basis functions. In [1], a *reinforced regression algorithm* was proposed in order to substantially reduce the number of (initial) basis functions. The initial regression basis is then reinforced at each step of the backward induction with the approximate value function obtained from the previous induction step. For the optimal stopping problem due to a reward process g_j , i.e.,

$$v_0^*(X_0) = \sup_{\substack{\tau \text{ stopping time,} \\ 0 \leq \tau \leq J}} \mathbb{E}[g_\tau(X_\tau)], \quad \text{where now the dynamic program principle reads}$$

$$v_j^*(x) = \max \left(g_j(x), \mathbb{E} \left[v_{j+1}^*(X_{j+1}) \mid X_j = x \right] \right),$$

the method in [1] comes down to the following backward algorithm:

Initialize $v_J = g_J$ at $j = J$. Then approximate the continuation function at step j by

$$c_j(x) := \sum_{k=1}^K \gamma_{j,k} \psi_k(x) + \gamma_{j,K+1} v_{j+1}(x) \approx \mathbb{E}_j \left[v_{j+1}^*(z, X_{j+1}) \mid X_j = x \right],$$

where the regression coefficients are the solution to the least-squares problem

$$\gamma_{j,1}, \dots, \gamma_{j,K+1} := \arg \min_{\gamma_1, \dots, \gamma_{K+1}} \sum_{m=1}^M \left| v_{j+1}(X_{j+1}^{(m)}) - \sum_{k=1}^K \gamma_k \psi_k(X_j^{(m)}) - \gamma_{K+1} v_{j+1}(X_j^{(m)}) \right|^2.$$

Next, set

$$v_j(x) := \max(g_j(x), c_j(x)). \quad (5)$$

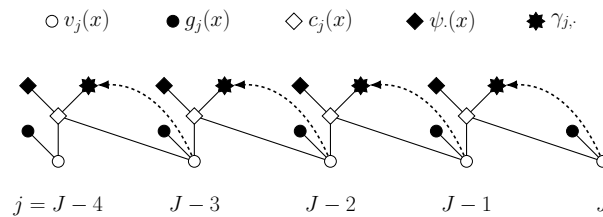

Fig. 1: The straight lines indicate the dependencies in the evaluation of c_j and v_j in (5). The dashed arrows start from the regression data v_{j+1} and symbolize the regression procedure.

The above procedure can be visualized by Figure 1.

The method in [1] is further extended to a *hierarchical reinforced regression (HRR) algorithm*; see WIAS Preprint no. 2792. In this algorithm, performed at level i , the initial basis is extended at times $j = J, \dots, 0$ with the functions $v_j^{i-1}(\cdot)$ obtained at level $i - 1$, respectively. As such, the HRR algorithm at level 0 comes down to the standard regression procedure, which goes back to [4].

Numerical examples

Bermudan max-call option. A popular benchmark example in the optimal stopping literature is the valuation of a Bermudan max-call option. This financial derivative is specified as follows: Given a basket of d assets with corresponding price process $(X^1(t), \dots, X^d(t))_{0 \leq t \leq T}$, the buyer can exercise the option right at any time τ within a predefined set of exercise dates $\{t_1, \dots, t_J\} \subset [0, T]$, upon which the pay off

$$e^{-r\tau} g_\tau(X_\tau) = (\max\{X_\tau^1, \dots, X_\tau^d\} - C)_+$$

will be received, where $(x)_+ := \max\{x, 0\}$, r is the interest rate, and $C > 0$ is called the *strike price* and is specified in the contract. The valuation of a Bermudan max-call option amounts to approximating the exercise rule maximizing the expected pay off and is thus an optimal stopping problem. Our framework covers more general types of contracts in which the buyer holds *multiple exercise rights*. The value of a Bermuda max-call option with L exercise rights is then given by

$$\sup_{0 \leq \tau_1 \leq \dots \leq \tau_L \leq T} \mathbb{E} \left[\sum_{i=1}^L g_{\tau_i}(X_{\tau_i}) \right],$$

where the \sup is taken over stopping times with respect to the filtration $(\mathcal{F}_j)_{j=1, \dots, J}$ of the system.

For the purpose of the benchmark example, a simple stochastic model for the evolution of the price process is chosen. More specifically, it is assumed that X has the following dynamics

$$dX^k(t) = (r - \delta) X^k(t) dt + X^k(t) \sigma dW^k(t), \quad X^k(0) = x_0, \quad 0 \leq t \leq T, \quad k \in \{1, \dots, d\},$$

where $(W^i)_{i=1, \dots, d}$ are independent Brownian motions, and $x_0, r, \delta, \sigma > 0$.

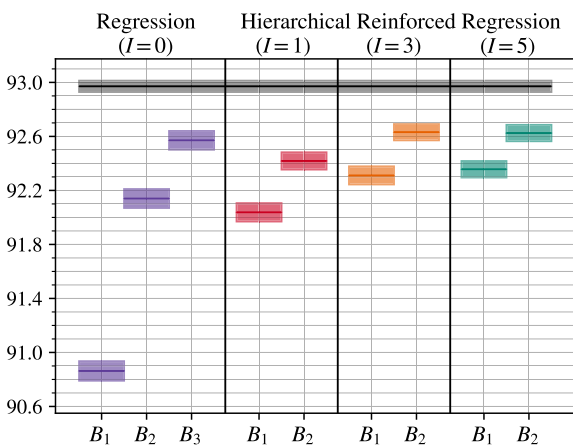

Fig. 2: Valuation of a Bermudan max-call option with multiple exercise rights. Comparison of lower bounds of the option's value obtained with the standard regression method and with the HRR method using basis functions of different complexity. The black horizontal line is an upper bound to the value, obtained by a dual method. The areas around the reported values represent the Monte Carlo errors.

Figure 2 presents lower approximations to the value of a Bermudan max-call option with $L = 4$ exercise rights. We compare values obtained with the standard regression method with values obtained with the HRR method. The regression basis functions B_1, B_2 , and B_3 are polynomials of degree 1, 2, and 3 respectively. Observe that the HRR with basis B_1 (resp. B_2) performs as

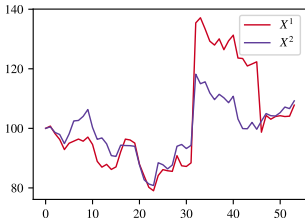

Fig. 3: Sample trajectory of the modeled weekly crude oil X^1 and natural gas X^2 prices

well as the standard regression method with the more complex basis B_2 (resp. B_3). Moreover, we see that increasing the recursion level I improves the lower bound; however, $I = 3$ seems to be sufficient.

Gas storage. We consider a gas storage problem of the kind introduced in the first section. In contrast to the example in the previous subsection, this optimal control problem is not of a multiple stopping type. It is reasonable to assume that the gas price is correlated with the oil price. We assume the following joint dynamics of the price of crude oil X^1 and the price of natural gas X^2

$$\begin{aligned} dX^1(t) &= \alpha_1(\beta - X^1(t))dt + \sigma_1 X^1(t)dW^1(t) + \left(J_{N(t^-)+1}^1 - X^1(t)\right)dN(t), \\ dX^2(t) &= \alpha_2(X^1(t) - X^2(t))dt + \sigma_2 X^2(t)dW^2(t) + \left(J_{N(t^-)+1}^2 - X^2(t)\right)dN(t), \end{aligned} \quad (6)$$

for $0 \leq t \leq T$, where $\beta, \alpha_i, \sigma_i > 0$ for $i = 1, 2$, W^1 and W^2 are correlated Brownian motions, N is a Poisson process, and $(J_k)_{k \geq 1}$ are independent and identically distributed normal random vectors. We approximate the stochastic differential equation (6) so that we obtain a discrete Markov chain $(X_j)_{j=1, \dots, J}$, representing the weekly prices over the course of one year.

I	Basis	Lower bounds
0	$B_1(X^2)$	70.489 (0.066)
	$B_1(X^1, X^2)$	70.635 (0.068)
	$B_2(X^2)$	71.253 (0.068)
	$B_2(X^1, X^2)$	71.402 (0.068)
	$B_3(X^1, X^2)$	71.333 (0.081)
	$B_4(X^1, X^2)$	71.498 (0.068)
1	$B_1(X^1, X^2)$	71.579 (0.070)

Table 1: Lower approximation to the value of a gas storage. We compare the values obtained with the HRR method ($I = 1$) to the values obtained with the standard regression method ($I = 0$) and basis functions of different complexity. Monte Carlo errors are reported in parentheses.

In Table 1, we present lower approximations to the value of the gas storage problem. In this example, we have assumed that the facility is initially loaded with half its capacity. Two types of regression bases were considered: polynomials of degree up to i only in the gas price denoted by $B_i(X^2)$, and polynomials up to degree i in both oil and gas price denoted by $B_i(X^1, X^2)$. In view of the lower bounds, we observe that the HRR ($I = 1$) method with the linear basis $B_1(X^1, X^2)$ outperforms the standard regression method ($I = 0$) with any of the considered basis functions, including polynomials up to degree four in both variables.

References

- [1] D. BELOMESTNY, J.G.M. SCHOENMAKERS, V. SPOKOINY, B. ZHARKYNBAY, *Optimal stopping via reinforced regression*, *Comm. Math. Sci.*, **16**:1 (2020), pp. 109–121.
- [2] H. PHAM, *Continuous-time Stochastic Control and Optimization with Financial Applications*, Springer-Verlag, Berlin Heidelberg, 2009.
- [3] R.S. SUTTON, A.G. BARTO, *Reinforcement Learning: An Introduction*, MIT Press, Cambridge, MA, 2018.
- [4] J. TSITSIKLIS, B. VAN ROY, *Regression methods for pricing complex American style options*, *IEEE Trans. Neural Netw. Learn. Syst.*, **12**:14 (2001), pp. 694–703.

2 WIAS in 2020

- Profile
- Structure and Scientific Organization
- Equal Opportunity Activities
- Grants
- Participation in Structured Graduation Programs
- Scientific Software

Profile
Structure
Activities
Grants
Participation
Software

2.1 Profile

The *Weierstrass Institute for Applied Analysis and Stochastics (WIAS)*, *Leibniz Institute in Forschungsverbund Berlin e. V. (FVB)* is one of eight (from 2021 onward: seven) scientifically independent institutes forming the legal entity FVB. All the institutes of FVB are individual members of the *Leibniz Association (WGL)*. The *Director of WIAS* is responsible for the scientific work at WIAS, the *Managing Director of the Common Administration of FVB* is in charge of its administrative business. The official German name of the institute is *Weierstraß-Institut für Angewandte Analysis und Stochastik, Leibniz-Institut im Forschungsverbund Berlin e. V.*

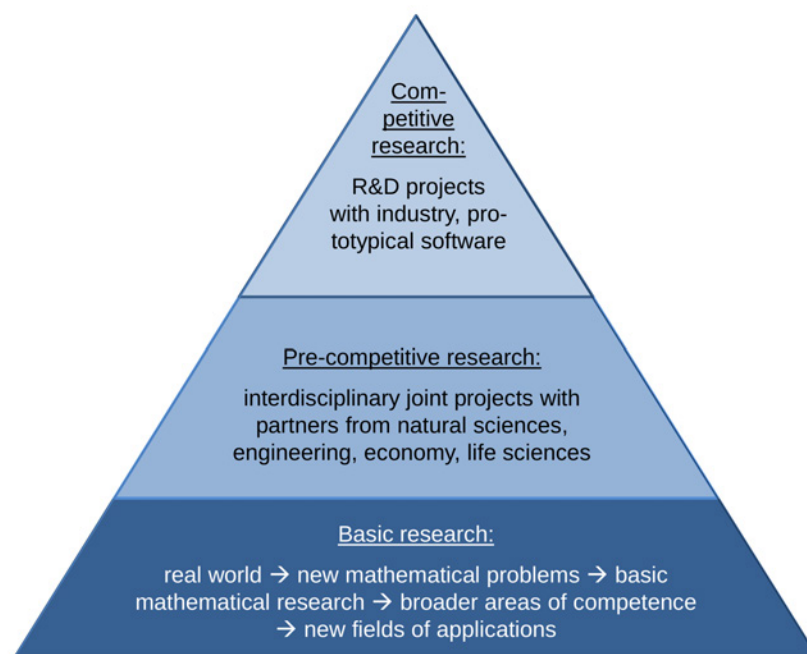

The mission of WIAS is to carry out *project-oriented* research in applied mathematics. WIAS contributes to the solution of complex economic, scientific, and technological problems of transregional interest. Its research is interdisciplinary and covers the entire process of problem solution, from mathematical modeling to the theoretical study of the models using analytical and stochastic methods, to the development and implementation of efficient and robust algorithms, and the simulation of technological processes. In its field of competence, WIAS plays a leading role in Germany and worldwide. WIAS's successful research concept is based on the above pyramid-shaped structure: Right at the bottom, basic mathematical research dedicated to new mathematical problems resulting from real-world issues as well as research for broadening mathematical areas of competence for developing new, strategically important fields of application. Based on this foundation, precompetitive research, where WIAS cooperates in interdisciplinary joint projects with partners from the natural sciences, engineering, economy, and life sciences. On top, cooperations with industry in R&D projects and the development of prototypical software. Close cooperations with companies and the transfer of knowledge to industry are key issues for WIAS.

A successful mathematical approach to complex applied problems necessitates a long-term multiply interdisciplinary collaboration in project teams. Besides maintaining the contact to the partners from the applications, which means, in particular, to master their respective technical terminologies, the WIAS members have to combine their different mathematical expertises and software engineering skills. This interdisciplinary teamwork takes full advantage of the possibilities available in a research institute.

The Weierstrass Institute is dedicated to university education on all levels, ranging from the teaching of numerous classes at the Berlin universities and the supervision of theses to the mentoring of postdoctoral researchers and to the preparation of, currently, two trainees to become “mathematical technical software developers”.

WIAS promotes the international collaboration in applied mathematics by organizing workshops and running guest programs. The institute is embedded in a dense network of scientific partners. In particular, it maintains various connections with Leibniz institutes and actively takes part in the forming and development of strategic networks in its fields. Thus, the WIAS coordinates the Leibniz Network “Mathematical Modeling and Simulation (MMS)” connecting 31 partners from all sections of the Leibniz Association. Modern methods of MMS are imperative for progress in science and technology in many research areas. The activities of the network are supported by a grant from the Strategic Fund of the Leibniz Association. Unfortunately, the “5th Leibniz MMS Days”, scheduled to take place at the end of March 2020 at the Potsdam Institute for Climate Impact Research, as well as the “3rd MMS Summer School” (on Mathematical Aspects of Machine Learning) had to be postponed due to the pandemic. Instead, new formats like the Leibniz MMS Online Symposium have been introduced.

WIAS has a number of cooperation agreements with universities. The main joint project with the Berlin universities is MATH+, the Berlin Mathematics Research Center, an interdisciplinary Cluster of Excellence and cross-institutional venture of Freie Universität Berlin, Humboldt-Universität zu Berlin, Technische Universität Berlin, WIAS, and Zuse Institute Berlin (ZIB), which has been funded since January 2019. The WIAS Director, Michael Hintermüller, is a founding member (PI) of MATH+, one of three co-speakers of the center, and a Scientist-in-Charge of MATH+’ Emerging Field *Model-based Imaging*. The structure of MATH+ integrates and merges the Research Center MATHEON, which was funded from 2002 to 2014 by the DFG and subsequently by the Einstein Center for Mathematics ECMath, the Berlin Mathematical School (BMS), and others.



2.2 Structure and Scientific Organization

2.2.1 Structure

In 2020, WIAS was organized into the following divisions for fulfilling its mission: Eight research groups, one Leibniz group, one Weierstrass group, and one Focus Platform¹ form the scientific body of the institute. In their mission, they are supported by the departments for technical and administrative services.

¹In the following, the terms “research group” will often be abbreviated by “RG”, “Leibniz group” by “LG”, Weierstrass group by “WG”, and Focus Platform by “FP”.

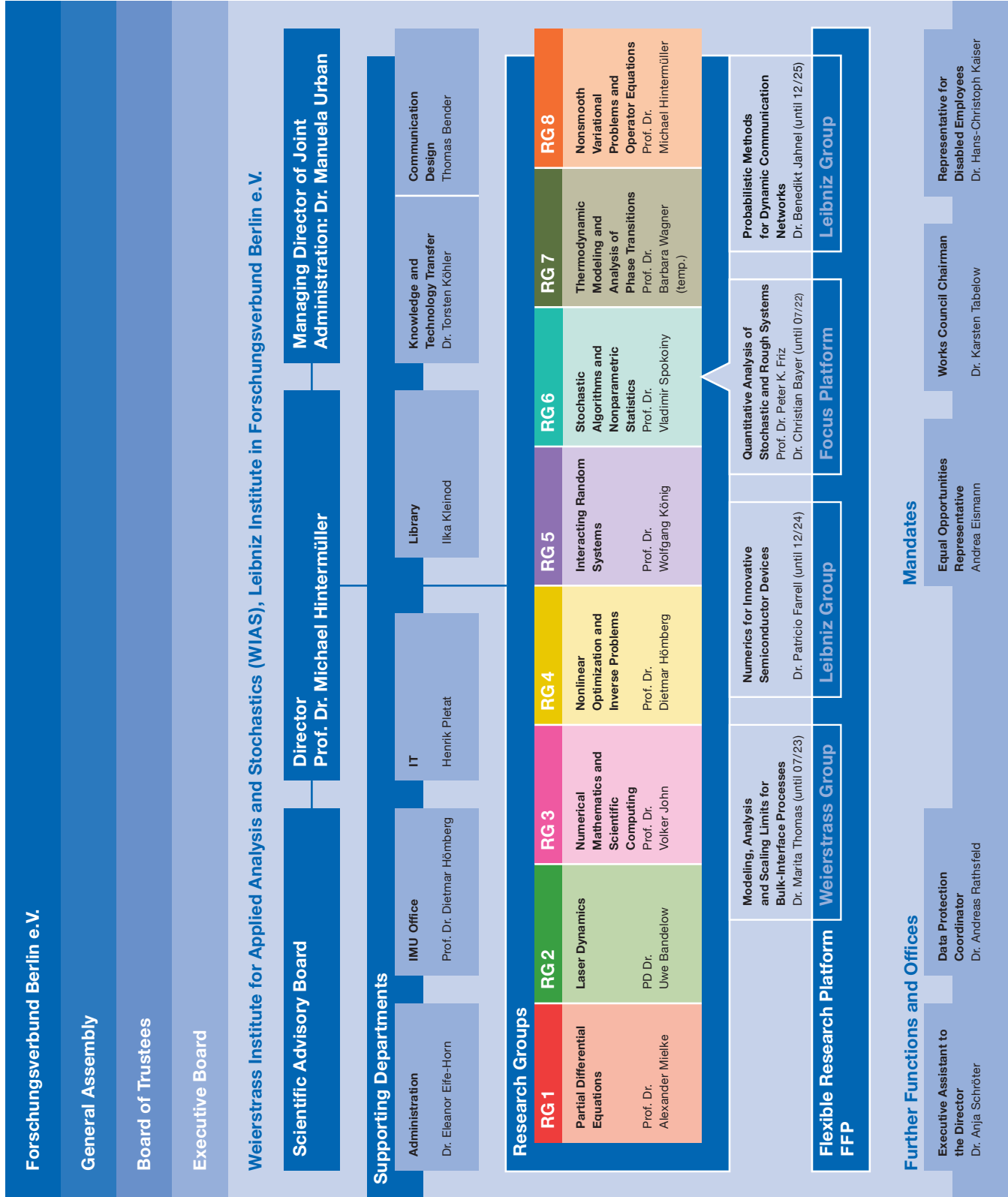

The Secretariat of the International Mathematical Union (IMU, see page 62), hosted by WIAS, is a supportive institution for the international mathematical community. Moreover, WIAS hosts the German Mathematics Association DMV and the Society of Didactics of Mathematics GDM.

Research Groups:

RG 1. Partial Differential Equations

RG 2. Laser Dynamics

RG 3. Numerical Mathematics and Scientific Computing

RG 4. Nonlinear Optimization and Inverse Problems

RG 5. Interacting Random Systems

RG 6. Stochastic Algorithms and Nonparametric Statistics

RG 7. Thermodynamic Modeling and Analysis of Phase Transitions

RG 8. Nonsmooth Variational Problems and Operator Equations

Flexible Research Platform:

LG 5. Numerical Methods for Innovative Semiconductor Devices

WG 1. Modeling, Analysis, and Scaling Limits for Bulk-Interface Processes

FP 1. Quantitative Analysis of Stochastic and Rough Systems

The organization chart on page 50 gives an overview of the organizational structure of WIAS in 2020.

2.2.2 Main Application Areas

The research at WIAS focused in 2020 on the following *main application areas*, in which the institute has an outstanding competence in modeling, analysis, stochastic treatment, and simulation:

- **Conversion, Storage, and Distribution of Energy**
- **Flow and Transport**
- **Materials Modeling**
- **Nano- and Optoelectronics**
- **Optimization and Control in Technology and Economy**
- **Quantitative Biomedicine**

To these areas, WIAS made important contributions in the past years that strongly influenced the directions of development of worldwide research.

2.2.3 Contributions of the Groups

The eight Research Groups, the Leibniz Group, and the Weierstrass Group form the institute's basis to fully bring to bear and develop the scope and depth of its scientific expertise. A Focus Platform,

on the other hand, represents an interesting topical focus area in its own right and operates under the umbrella of one or more Research Groups. The mathematical problems studied by the groups originate both from short-term requests arising during the solution process of real-world problems, and from the continuing necessity to acquire further mathematical competence as a prerequisite to enter new fields of applications, calling for a well-directed long-term *basic research in mathematics*.

The table gives an overview of the main application areas to which the groups contributed in 2020 in the interdisciplinary solution process described above (dark color: over 20% of the group's working time, light color: up to 20% of the group's working time, blue: no contribution).

Main Application Areas	RG 1	RG 2	RG 3	RG 4	RG 5	RG 6	RG 7	RG 8	WG 1	LG 5
Conversion, Storage, and Distribution of Energy	Light	Light	Light	Light	Light	Light	Dark	Dark	Light	Dark
Flow and Transport	Light	Light	Light	Light	Light	Light	Dark	Light	Dark	Light
Materials Modeling	Dark	Light	Light	Light	Light	Light	Dark	Light	Dark	Light
Nano-/Optoelectronics	Dark	Dark	Light	Light	Light	Light	Light	Light	Light	Dark
Optimization & Control in Technology and Economy	Light	Light	Light	Light	Light	Light	Light	Dark	Light	Light
Quantitative Biomedicine	Light	Light	Light	Light	Light	Light	Dark	Dark	Light	Light

In the following, special research topics are listed that were addressed in 2020 within the general framework of the main application areas.

Conversion, Storage and Distribution of Energy

This main application area takes account of an economic use of energetic resources based on mathematical modeling and optimization. With regard to future developments, sustainability and aspects of electro-mobility play a major role. Lithium-ion batteries belong to the key technologies for storing renewable energy, for which mathematical models are developed in RG 7. Modern mathematical methods such as homogenization techniques enable a sound description of porous battery electrodes. With this, some key aspects are the prediction of the cell voltage, the incorporation of ageing phenomena, and validation with experimental data. RG 3 and RG 7 cooperate in modeling the transport processes and their evaluation by simulations. A further focus is put on the phase-field modeling of the liquid phase crystallization of silicon in order to develop optimized thin-film solar cells in the framework of an interdisciplinary research project. Furthermore, RG 4 and RG 8 investigate aspects of uncertainty in energy management via stochastic optimization or uncertainty quantification, respectively. Here, the emphasis is put on gas networks and renewable energies with uncertain parameters given, e.g., by demand, precipitation, or technical coefficients. In this

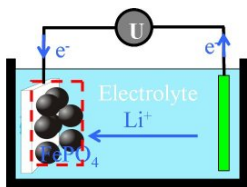

Fig. 1: Sketch of a lithium-ion battery (LiFePO_4)

context, new perspectives in modeling and analyzing equilibria in energy markets with random parameters and when coupling markets with the underlying physical or continuum mechanical properties of the energy carrier in a power grid open up.

Core areas:

- Light-emitting diodes based on organic semiconductors (OLEDs; in RG 1 and RG 3)
- Modeling of experimental electrochemical cells for the investigation of catalytic reaction kinetics (in RG 3)
- Lithium-ion batteries (in RG 3 and RG 7)
- Modeling and analysis of coupled electrochemical processes (fuel cells, batteries, hydrogen storage, soot; in RG 3 and RG 7)
- Nonlinear chance constraints in problems of gas transportation (in RG 4)
- Parameter identification, sensor localization, and quantification of uncertainties in switched PDE systems (in RG 8)
- Modeling and simulation of charge transport in perovskite solar cells (in LG 5)

Flow and Transport

Flow and transport of species are important in many processes in nature and industry. They are generally modeled by systems consisting of partial differential equations. Research groups at WIAS are working at the modeling of problems, at the development and analysis of discretizations for partial differential equations, at the development of scientific software platforms, and the simulation of problems from applications. Aspects of optimization, inverse problems (parameter estimation), and stochastic methods for flow problems become more and more important in the research of the institute.

Core areas:

- Thermodynamic models and numerical methods for electrochemical systems (in RG 1, RG 3, and RG 7)
- Development and analysis of physically consistent discretizations (in RG 3 and LG 5)
- Modeling and numerical methods for particle systems (in RG 1, RG 3, and RG 5)
- Modeling of nanostructures of thin films (in RG 7)
- Computational hemodynamics (in RG 3 and RG 8)
- Scientific software platforms `ParMooN` and `pdelib` (in RG 3)
- Description of random message trajectories in spatial telecommunication models (in RG 5)
- Thermomechanical modeling, analysis, and simulation of multiphase flows (with free boundaries; in RG 7 and WG 1)

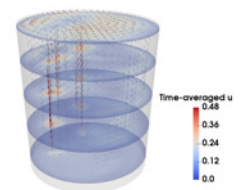

Fig. 2: Time-averaged turbulent flow through a ladle

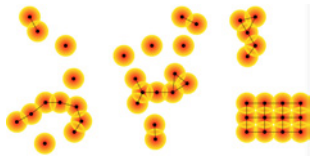

Fig. 3: A realisation of a many-body system showing a small crystal in the lower right corner

Materials Modeling

Modern materials increasingly show multi-functional capabilities and require precise and systematically derived material models on many scaling regimes. To include theories from the atomistic to the continuum description, multi-scale techniques are at the core in the derivation of efficient models that enable the design of new materials and processes and drive the development of new technologies. Combining stochastic and continuum modeling with numerical methods and the rigor of mathematical analysis to address some of today's most challenging technological problems is a unique characteristic of WIAS.

Core areas:

- Homogenization and localization in random media (in RG 1 and RG 5)
- Models of condensation and crystallization in interacting many-particle systems (in RG 3, RG 5, and RG 6)
- Asymptotic analysis of nano- and microstructured interfaces, including their interaction with volume effects (in RG 7 and WG 1)
- Dynamical processes in nonhomogeneous media (in WG 1, RG 1, RG 6, and RG 7)
- Material models with stochastic coefficients (in RG 1, RG 4, RG 5, and RG 7)
- Modeling and analysis of complex fluids including suspensions, hydrogels, polyelectrolytes (in RG 7 and WG 1)
- Thermodynamically consistent electrochemical models of lithium-ion batteries, fuel cells, and solid oxide electrolytes (in RG 3 and RG 7)
- Stochastic and thermomechanical modeling of phase transitions (in RG 4 and RG 5)
- Hysteresis effects, e.g., in electro/magneto-mechanical components, elastoplasticity, lithium batteries (in RG 1, WG 1, and RG 7)
- Modeling of elastoplastic and phase-separating materials including damage and fracture processes (in RG 1, RG 7, and WG 1)
- Derivation and analysis of local and nonlocal phase field models and their sharp-interface limits (in RG 7 and WG 1)
- Modeling and simulation of electronic properties of perovskites (in LG 5)

Nano- and Optoelectronics

Optical technologies count among the most important future-oriented industries of the 21st century, contributing significantly to technological progress. They facilitate innovative infrastructures, which are indispensable for the further digitalization of industry, science, and society.

Mathematical modeling, numerical simulation, as well as theoretical understanding of the occurring effects are important contributions of WIAS to today's technological challenges. A central topic is the modeling and mathematical analysis of the governing equations and the simulation of semiconductor devices.

Core areas:

- Microelectronic devices (simulation of semiconductor devices; in RG 1, RG 3 and LG 5)
- Mathematical modeling of semiconductor heterostructures (in RG 1 and LG 5)
- Diffractive optics (simulation and optimization of diffractive devices; in RG 2 and RG 4)
- Quantum mechanical modeling of nanostructures and their consistent coupling to macroscopic models (in RG 1 and RG 2)
- Laser structures and their dynamics (high-power lasers, single-photon emitters, quantum dots; in RG 1, RG 2, and RG 3)
- Fiber optics (modeling of optical fields in nonlinear dispersive optical media; in RG 2)
- Photovoltaics, OLED lighting, and organic transistors (in RG 1 and RG 3)
- Electronic properties of nanostructures such as nanowires (in RG 1)

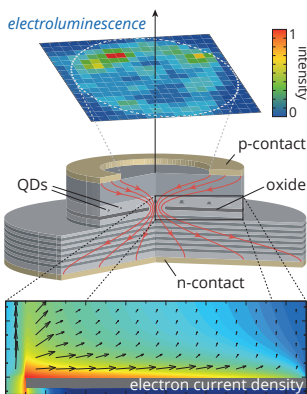

Fig. 4: Simulated spreading of injection current density in a quantum-dot based single photon emitter with Al-oxide aperture. An improved design was proposed on that base in: M. KANTNER, U. BANDELOW, T. KOPRUCKI, J.-H. SCHULZE, A. STRITTMATTER, H.-J. WÜNSCHE, Efficient current injection into single quantum dots through oxide-confined PN diodes, *IEEE Trans. Electron Devices*, **63:5** (2016), pp. 2036–2042.

Optimization and Control in Technology and Economy

For planning and reconfiguration of complex production chains as they are considered in the Industry 4.0 paradigm as well as for innovative concepts combining economic market models and the underlying physical processes, e.g., in energy networks, modern methods of algorithmic optimal control are indispensable. In many of these problems, different spatial and temporal scales can be distinguished, and the regularity properties of admissible sets play an important role.

Applications may range from basic production processes such as welding and hardening to the design of diffractive structures and simulation tasks in process engineering industry to optimal decision in financial environments such as financial (energy) derivatives, energy production, and storage.

Core areas:

- Simulation and control in process engineering (in RG 3, RG 4, and RG 6)
- Problems of optimal shape and topology design (in RG 4 and RG 8)

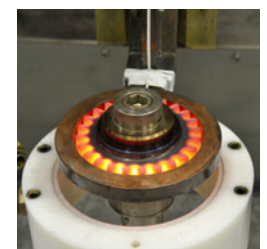

Fig. 5: Induction heat treatment of a gear

- Optimal control of multifield problems in continuum mechanics and biology (in RG 3, RG 4, and RG 7)
- Analysis of the spread of malware through a spatial ad-hoc telecommunication system and of the influence of random countermeasures (in RG 5)
- Nonparametric statistical methods (image processing, financial markets, econometrics; in RG 6)
- Optimal control of multiphase fluids and droplets (in RG 8)

Quantitative Biomedicine

Quantitative Biomedicine is concerned with the modeling, analysis, simulation, or optimization of various highly relevant processes in clinical practice. Not only the modeling of cellular, biochemical, and biomolecular processes, but also applications in medical engineering, such as the modeling, simulation, and optimization of prostheses or contributions to the area of imaging diagnostics, are major focus topics.

At WIAS, problems from image and signal processing with applications especially in the neurosciences are considered. They include classical tasks like registration, denoising, equalization, and segmentation. Moreover, (low-rank/sparse) data decomposition and functional correlations, e.g., in neurological processes, are also studied. These processes typically lead to complex, nonlinear, or nonsmooth inverse problems where often also statistical aspects play a central part for data modeling and analysis methods. The current focus of research is the consideration of (bio-)physics-based models for data and image analysis. Furthermore, mathematical models for a better understanding of haemodynamic processes are developed, analyzed, and simulated. These models are then employed for the prognosis or optimization after medical interventions, using, e.g., model reduction and optimization techniques with partial differential equations. Other foci are the modeling and analysis of time-based systems, e.g., cartilage reconstruction, calcium release.

Core areas:

- Numerical methods for biofluids and biological tissues (in RG 3 and RG 8)
- Image processing (in RG 6 and RG 8)
- Modeling of high-resolution magnetic resonance experiments (in RG 6)
- Free boundary models for actin filament networks (in RG 7)
- Modeling of a nanopore for the analysis of DNA-type macromolecules (in RG 7)
- (Bio-)physics-based quantitative imaging (in RG 6 and RG 8)

2.3 Equal Opportunity Activities

WIAS is committed to an equal opportunities policy that aims at increasing the number of women among the scientific staff and especially in leading positions. This aim is to be achieved both

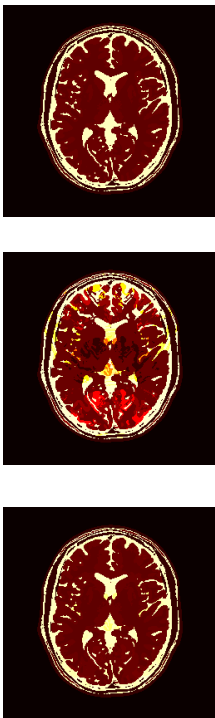

Fig. 6: Quantitative MRI: Estimation of the T_2 relaxation times of matter leading to characterization of different types of tissue. (1) Ground truth, (2) State-of-the-art dictionary-based method (improved variant of Magnetic Resonance Fingerprinting-MRF), (3) Integrated physics-based approach where the physical processes are learned by an artificial Neural Network

by creating a family-friendly environment and by the equal opportunities officer's involvement in staffing procedures.

In accordance with a decision of the WIAS scientific management, one of its members is appointed to take charge of equal opportunities issues for the period of one year. Volker John, Head of Research Group 3 “Numerical Mathematics and Scientific Computing” was designated as the person in charge in 2020. In January, the Female Master Students Program was started; in the course of 2020, three female master's degree candidates were recruited as student assistants. In February, the new WIAS Gender Equality Plan 2020–2023 was approved. In September, Andrea Eismann was elected the new equal opportunities officer and Jutta Lohse her deputy. Andrea Eismann was also charged with diversity issues at WIAS. In autumn 2020, the equal opportunities officers of WIAS helped organizing and conducting the online election of the first Central Equal Opportunities Officer of the Forschungsverbund Berlin, which took place in November 2020. The equal opportunities officers of the FVB institutes had campaigned for a very long time to have such a position to support their work.

audit berufundfamilie. Since 2014, WIAS has been certified and recertified as a family-friendly employer by the *audit berufundfamilie*. This certificate documents the institute's dedication to a sustainable family- and life-phase-conscious personnel policy. Although not all measures envisaged could be implemented due to COVID-19, our already high standards of family-friendliness established in the “Company agreement regarding the compatibility of career and family” and the “Objective agreement for confirmation of the certificate for the *audit berufundfamilie*” were further improved and consolidated. Employees can, for instance, make use of the services offered by the family service *benefit@work* at no charge. In face of COVID-19, the *work and family* team and the institute's IT department have – as a matter of course with the active support of the institute's management – promoted the speedy implementation of working from home.

The *work and family* team, which monitors and supports the implementation of family-friendly policies at WIAS, comprised in 2020 Olaf Klein (project head of the *audit berufundfamilie*), Volker John (management), Jutta Lohse, and Laura Wartenberg, who is responsible for the team's internet presence. In 2020, the team completed the final report for the certification period 2017–2020. WIAS received the certificate for the consolidation period on June 15 (online), which is valid up to March 15, 2023. Apart from this, the team informed the staff about relevant issues and events (updates of COVID-19 policies and announcements of webinars and online talks on parenting, care for family members, stress coping, working from home and child care, etc.). For example, there was a link to a webinar on home office and child care offered in the WIAS intranet. Unfortunately, due to COVID-19, not all measures that were planned could be implemented. It was more important to contain the virus. For example, the administration had to stop the organization of opportunities for individual massage units at the institute for sustaining the employees' general health. Many colleagues worked from home. Instead of a Christmas party for the children of the collaborators, this year “Father Christmas” wrote a letter to the children asking them to send him Christmas drawings.



2.4 Grants

The raising of grants under scientific competition is one of the main indicators of scientific excellence and thus plays an important role in the efforts of WIAS. In this task, WIAS was very successful in 2020, having raised a total of 3.3 million euros, from which 42 additional researchers² (plus 7 outside WIAS; Dec. 31, 2020) were financed. In total in 2020, 22.6 percent of the total budget of WIAS and 41.58 percent² of its scientific staff originated from grants.

For a detailed account of projects funded by third parties, the reader is referred to the appendix, Section A.2 Grants below on pages 121ff.

2.5 Participation in Structured Graduation Programs

Graduate School *Berlin Mathematical School (BMS)*



Berlin's mathematicians are proud that, after its successful installation in 2006, a second funding period was granted to this graduate school in Summer 2012 for 2013–2018, for the excellent work done since its inception. Since 2019, the BMS is a part of MATH+. The BMS is jointly run by the three major Berlin universities within the framework of the German Initiative for Excellence. It attracts excellent young Ph.D. students from all over the world to the city, and many members of WIAS are contributing to its operations.

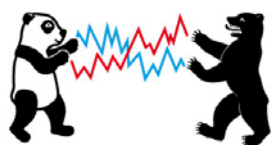

International Research Training Group (IRTG) 1792 *High Dimensional Non Stationary Time Series Analysis of the DFG*

In October 2013, this International Research Training Group took up its work for 4.5 years. The faculty consists of internationally renowned scholars from Humboldt-Universität zu Berlin, WIAS (RG 6), Freie Universität Berlin, the German Institute for Economic Research (DIW), and Xiamen University in China. In December 2017, the IRTG was prolonged until September 2022.



International Research Training Group (IRTG) 2544 *Stochastic Analysis in Interaction of the DFG*

In 2020, this International Research Training Group was installed for 4.5 years at the TU Berlin; it is run jointly with the HU Berlin, FU Berlin, the WIAS (RG 5 and RG 6) and the University of Oxford. It is a particularly visible activity of the Oxford–Berlin Research Partnership, which has been launched by a Memorandum of Understanding in December 2017. For more information see <https://www.berlin-university-alliance.de/commitments/international/oxford/index.html> and <https://www3.math.tu-berlin.de/stoch/IRTG/>.

²Including scholarship holders.

2.6 Scientific Software

Scientific software is a tool to evaluate models and algorithms investigated at WIAS. Moreover, software helps to transfer research results to other scientific fields, to industry, and to the general public. The underlying problems often pose very specific and advanced requirements, which cannot be satisfied by standard software that is widely available; hence, the development of algorithms and scientific software belongs to the scientific tasks of WIAS. As a consequence, WIAS is working on the implementation of rules of good scientific practice in the realm of software development. Software-based publications in specific journals and as WIAS Technical Reports are encouraged. The production, dissemination, and sale of software is not part of the core duties of WIAS. Nevertheless, several codes developed at WIAS are distributed outside of WIAS and have earned a good reputation. See page 174ff. for a list of software packages that WIAS makes available. Licensing models depend on the specifics of the corresponding projects. Codes are offered under open source and proprietary licenses as well as combinations thereof.

3 IMU@WIAS

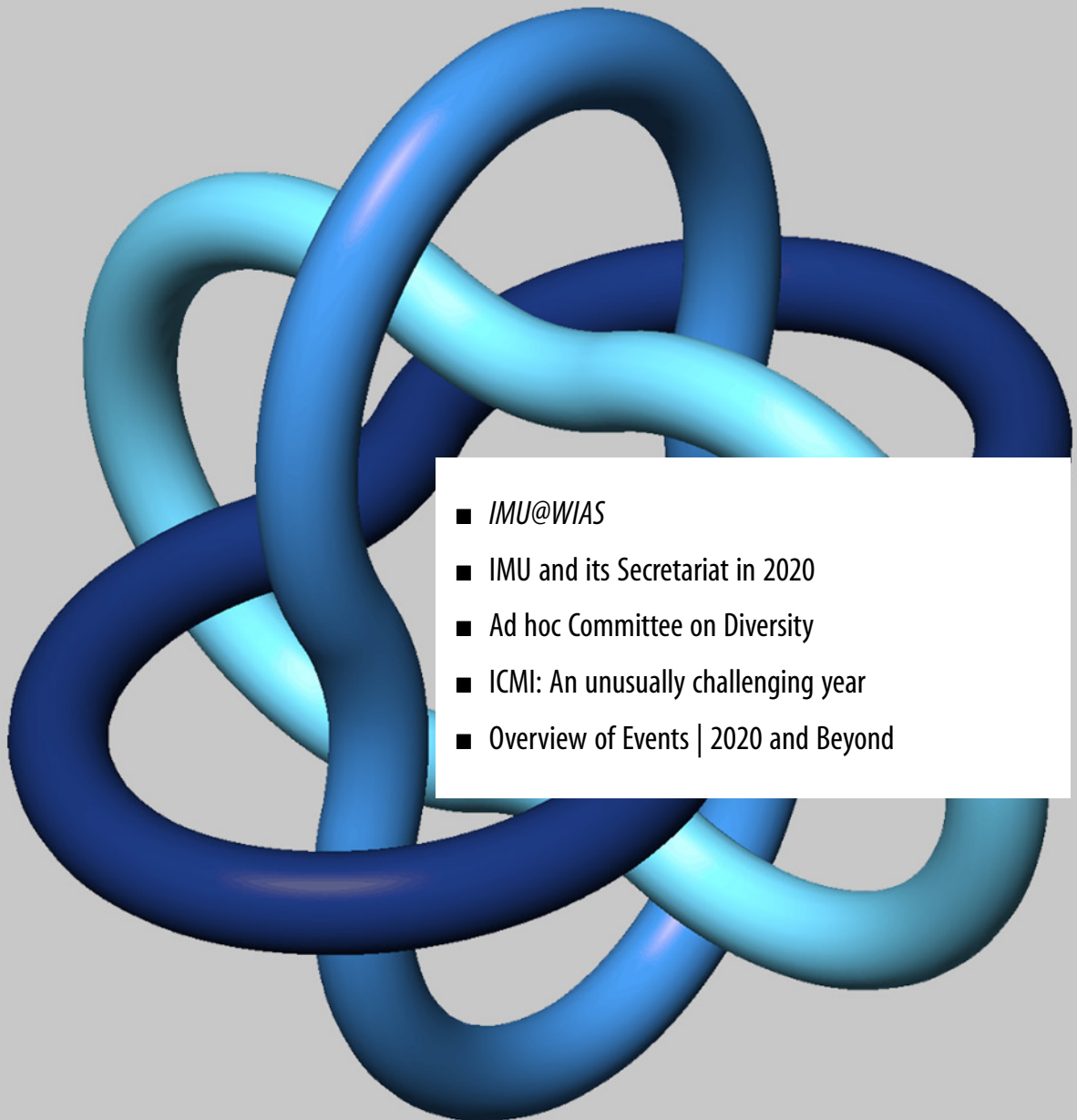

- *IMU@WIAS*
- IMU and its Secretariat in 2020
- Ad hoc Committee on Diversity
- ICMI: An unusually challenging year
- Overview of Events | 2020 and Beyond

3.1 The Secretariat of the International Mathematical Union



Since January 2011, the Secretariat of the International Mathematical Union (IMU) has been permanently based in Berlin, Germany, at WIAS. Under the supervision of the IMU Executive Committee, the Secretariat runs IMU's day-to-day business and provides support for many IMU operations, including administrative assistance for the International Commission on Mathematical Instruction (ICMI) and the Commission for Developing Countries (CDC) as well as mainly technical assistance for the Committee on Electronic Information and Communication (CEIC) and the Committee for Women in Mathematics (CWM). The IMU Secretariat also hosts the IMU Archive.

The collaboration of WIAS and the IMU was installed via a Memorandum of Understanding (2010) and a Cooperation Agreement (2013) that covered an initial period of ten years. After a positive evaluation of the work of the IMU Secretariat during the period 2011–2018, the IMU General Assembly 2018 passed a resolution to enter into a new and unlimited Cooperation Agreement, which was signed immediately after the General Assembly meeting.

The offices of the IMU Secretariat are located on the fourth floor of Hausvogteiplatz 11A, close to the main building of WIAS.

Staff members



Dietmar Hömberg, *Head of the IMU Secretariat and IMU Treasurer*. D. Hömberg is a professor at Technische Universität Berlin, and head of Research Group 4 at WIAS. He took over as Head of the Secretariat and IMU Treasurer from his predecessor Alexander Mielke in July 2020. In his function as the Head of the Secretariat, he is responsible for the IMU Secretariat as a separate unit within WIAS. He also took over as IMU Treasurer in July 2020, following his appointment by the IMU Executive Committee, and is thus responsible for all financial aspects, including collecting dues, financial reports, and drafting the budget of the IMU.

Scott Jung, *Manager of the IMU Secretariat*. S. Jung joined the IMU Secretariat in February 2020, formally taking over as Manager of the Secretariat in March 2020. His responsibilities include heading and supervising all administrative operations of the Secretariat and actively participating in the implementation of the decisions and duties of the IMU Executive Committee and the IMU General Assembly, which is done in close cooperation with the IMU Secretary General. He communicates with IMU member countries, drafts written materials, writes minutes and reports, and supervises the IMU website. His tasks include steering and overseeing the Secretariat's business operations and IMU finances, as well as monitoring deadlines.

Lena Koch, *ICMI and CDC Administrative Manager*. L. Koch returned from leave in February 2020 and resumed her duties as ICMI and CDC Administrative Manager. Responsibilities include administratively supporting the activities of the Commission for Developing Countries and the International Commission on Mathematical Instruction. This refers, in particular, to promoting the work of both commissions, managing their web presence — including public relations and communication — and handling grant applications and support programs.

Mariusz Szmierlo, *IMU Accountant*. M. Szmierlo joined the IMU in June 2020 and is, under the supervision of the IMU Treasurer, in charge of executing the financial decisions of IMU, which includes budget management of the IMU Secretariat, application for and supervision of third-party funds, handling membership dues, all financial aspects of grants, and administering expense reimbursements.

Birgit Seeliger, *IMU Archivist*. B. Seeliger is responsible for the IMU Archive and in charge of developing a strategy for preserving and making paper documents, photos, pictures, and IMU artifacts accessible, as well as supporting the decision process concerning the electronic archiving of the IMU's steadily increasing digital documentation.

Frank Klöppel, *IT and Technical Support*. F. Klöppel is responsible for running the IT operations of the IMU Secretariat. This includes taking care of running the hardware and software infrastructure, in particular, the IMU server and mailing lists, and planning the extension of the IMU's IT services for its members, commissions, and committees.

Imren Karci, *Project Assistant*. I. Karci's task is to support the administrative work of the IMU Secretariat, in particular, to assist in the organizational handling of CDC programs and general IMU activities.

The IMU Secretary General

Helge Holden is the IMU Secretary General. He holds a professorship at the Norwegian University of Science and Technology, Trondheim. He is in contact with the IMU Secretariat regularly via electronic communication and visits the office about once a month.

The Secretary General is responsible for conducting the ordinary business of the Union and for keeping its records.

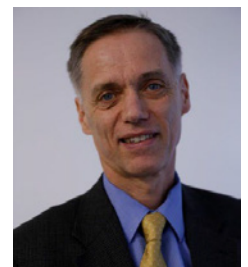

Staff changes at the Secretariat

The IMU Secretariat experienced significant changes in personnel over the course of 2020, most notably in its leadership. Manager of the IMU Secretariat Sylwia Markwardt retired from the Secretariat in March 2020, and Alexander Mielke ended his tenure as Head of the Secretariat at the end of June 2020.



Fig. 1: Sylwia Markwardt and Alexander Mielke during the ICM2014 in Seoul

Alexander Mielke and Sylwia Markwardt had been in their respective leadership roles since the Secretariat's inception at WIAS in 2011. They were integral in shaping its working scope and remit, overseeing its development and ensuring its successful functioning. The gratitude owed to their engagement and hard work cannot be overstated. Both the IMU and WIAS thank Alexander Mielke and Sylwia Markwardt for their outstanding dedication and service.

In terms of their successors, Scott Jung took over as Manager in March 2020 and Dietmar Hömberg assumed his role as Head in July 2020. This change in personnel was successfully enabled by careful planning and support for the transitions, further supplemented by the Secretariat's working excursion to Lutherstadt Wittenberg in March 2020. The excursion provided the opportunity for the Secretariat's members to focus on numerous operational aspects with a fresh perspective, to review, overhaul, and develop working processes, as well as to foster interpersonal and working relationships within the framework of the new team.

With Mariusz Szmerlo joining the Secretariat in June 2020 and filling the vacant position of IMU Accountant, the Secretariat was again at full capacity and able to deliver on its remit.

3.2 IMU and its Secretariat in 2020

2020 was a landmark year for the IMU, marking 100 years since the Union first came into being on September 20, 1920. While the events of 2020 unfortunately caused postponement of the centennial celebrations planned for September 2020, the significance of that milestone — as well as the relevance of the IMU's work and remit — remains undiminished. This is very much apparent

in the article that the IMU President Carlos E. Kenig produced for *Notices* of the American Mathematical Society on the IMU's centennial. Please find the article by kind permission of the American Mathematical Society under <https://www.mathunion.org/fileadmin/IMU/History/rnoti-p404.pdf>. Further information on *Notices* of the AMS can be found on <https://www.ams.org/notices>.

The work of the IMU and its Secretariat in 2020 was shaped by the impact of the COVID-19 pandemic, which influenced much of the method and delivery of the Union's and the Secretariat's operations. The manner in which business was conducted had to shift dramatically and rapidly to respond to developments in 2020. A number of major events were postponed to 2021 due to the pandemic, and the work of various committees was switched to virtual platforms. Similarly, various programs and the activities of grant recipients were also affected by the general global shutdown, especially when it came to travel and conferences.

As a specific example of the pandemic's impact on the operations of the IMU and its Secretariat, the standing meetings of the ICMI General Assembly and Executive Committee were unable to take place in Shanghai, China in July 2020 as planned. An exploration of how the Commission adapted to meet this particular challenge is given below in Section 3.4.

More broadly, the almost universal temporary ban on international travel and restrictions on large gatherings meant that numerous congresses, conferences, scientific meetings, and workshops planned for 2020 were either cancelled or postponed. Thus the traditional arena for exchanging ideas came to a halt. However, the IMU was aware that many groups were utilizing modern technological solutions to offer online seminars in which everyone could participate. The spread of infectious diseases has also long been studied by mathematicians and there were important initiatives in 2020 that continued this tradition. In response to this situation and its effect on many aspects of our work and community, the IMU launched under <https://www.mathunion.org/corona> a resource website with links to online resources covering general information, online seminars, and mathematical research on the pandemic.

It was the intention of the IMU to thus provide a resource website for many of these initiatives, to advocate for the work being undertaken by mathematicians and also to provide the broader mathematical community with the opportunity to access various resources and materials. This is just one example of a new initiative launched by the IMU in response to global developments in 2020. A further such initiative is treated in detail below.

3.3 Ad hoc Committee on Diversity

Helge Holden, IMU Secretary General

In 2020, there was a considerable increase of attention devoted worldwide to the issues of diversity and inclusion. Many institutions and organizations recognized the need to re-assess their relationship to the issues of diversity and inclusion.

The International Mathematical Union is the leading global organization in mathematics. As such it represents the mathematical community, and while it is not a large organization in terms of the

number of employees or its funds, it appoints or elects members of several important committees and commissions, it awards prestigious prizes, and it selects speakers for the flagship global mathematics event, the International Congress of Mathematicians (ICM).

In the past few years, there has already been increased attention to diversity in the IMU. This has been combined with an increased consideration of conflicts of interest and implicit biases. These changes have certainly improved the operations of the IMU. For the Commission for Developing Countries (CDC), diversity has always been an integral part of their activity. The successful creation of the Committee for Women in Mathematics (CWM) has increased the attention given to gender equality and the underrepresentation of women in mathematics. Also for the International Commission on Mathematical Instruction (ICMI), diversity in mathematics education has always been important.

To build on this, the IMU Executive Committee decided to create an ad hoc Committee on Diversity (CoD) that can offer the IMU advice regarding diversity and inclusion.

The defined purpose of CoD is threefold:

1. Assess how the IMU has performed to date;
2. Offer advice on how we can improve our performance;
3. Offer advice on how our members (the Adhering Organizations) can improve their performance nationally.

The work of the committee will be public, and the committee will be free to seek advice and engage in discussions wherever it finds it suitable. The committee has ten members. The chair of CoD is Robert Bryant (Duke University, US).

CoD's final report will first be discussed by the IMU Executive Committee, which will then make its recommendations to be discussed at the General Assembly in St. Petersburg prior to ICM 2022.

3.4 ICMI: An unusually challenging year



Jill Adler, ICMI President, and Abraham Arcavi, ICMI Secretary General

As a commission of the International Mathematical Union (IMU), the International Commission on Mathematical Instruction (ICMI) has two constituent bodies: the Executive Committee (EC) and the ICMI Representatives of the member states. Once every four years, the two bodies meet at the ICMI General Assembly (GA) for one day, prior to the beginning of the International Congress on Mathematical Education (ICME). An ICME is the largest worldwide event in mathematics education, gathering around 3 500 participants involved in the broad enterprise of mathematics education: researchers, mathematicians, teachers, teacher educators, graduate students, curriculum developers, and policy makers.

ICME-14 and the ICMI GA were scheduled to take place in July 2020 in Shanghai, China. Significant organization towards these two crucial events had taken place since 2017, both in the EC and in China.

Already in mid-February of this year, as the outbreak of COVID-19 in China became more widely known, the ICMI EC and the Local Organizing Committee for ICME–14 started to consider the possibility of postponing ICME–14 for a year, in spite of the huge logistic and financial implications of such a decision. By March 15, and in light of the outbreak becoming a global pandemic, the decision was finally made for such a postponement, and the corresponding announcement was made. ICME–14 is planned to take place in July 2021.

However, the GA needed to take place as planned since the term in office of the present EC expires by the end of 2020 and the new EC should be elected. The work of the ICMI Nominating Committee for the development of the slate for the members of the new ICMI 2021–2024 EC began at the end of 2018, and so preparation was in place for the slate to be presented to the community as planned in May 2020. Therefore for the first time in ICMI’s history, the GA had to be separated from the ICME Congress and had to take place virtually.

The ICMI EC and IMU Secretariat made all the arrangements to hold the GA online including the selection of a company to be hired for handling the election electronically. All reports and presentations that usually take place during the General Assembly were uploaded on a password-secured webpage created ad hoc. These materials included a short videotaped self-presentation of each candidate on the slate.

The GA then took place on July 13. Due to time differences, and in order to facilitate the participation of as many country representatives (CRs) as possible, the GA was reduced to one hour only (instead of the usual one-day meeting) in which the ICMI President summarized the activities of ICMI in the last four years and the Chair of the Nomination Committee introduced the slate.

A short amount of time was devoted to discuss issues that some CRs sent ahead of time. The following two days were allotted for the CRs to cast their votes. 55 CRs participated, more than would have been present in China. Fortunately, both the virtual meeting and the online election were conducted with no difficulties, and the 2021–2024 EC was duly elected. The support from the IMU Secretariat was crucial to the success of the first virtual ICMI General Assembly and the virtual election of the new ICMI EC.

The situation with the ICME–14, even with the agreed postponement to July 2021, is more complicated. Given that international travel is still extensively restricted, ICMI and the local organizers decided that the conference would be in a hybrid mode, on the planned dates in July 2021. The Chair of ICME–14 has communicated with all participants in the key components of the program, and there is wide commitment to continuing participation, with many indicating that they will participate online, and some indicating their intention to travel to China should this be possible.

In the spirit of ICMI, all international members of the International Program Committee (IPC) accepted to continue their work to support the Congress and the implications of both the postponement and the online format, which required many revisions of the original scientific program already agreed to by the end of 2019. For that purpose, the IPC met virtually early December 2020 over two days. The re-scheduling of the program required imagination and flexibility in order to accommodate real time accessibility to participants from most time zones. The IPC has also included additional activities to address global issues related to the pandemic and which are relevant to mathematics and mathematics education.

Since the ICMI EC 2017–2020 could not meet in Shanghai, the last meeting of the present Executive Committee was also held online on September 9–11, 2020, with the support of the IMU Secretariat. All the EC members (spanning across 10 time zones) attended, and many important decisions were made.



Fig. 2: A screenshot of the ICMI EC virtual meeting

On October 28–29, the present executive officers (President, Vice Presidents and Secretary General) met virtually with the incoming executive officers in order to ensure a smooth transition between ECs.

ICMI wishes to express deep gratitude to the ongoing and vital support provided by WIAS and, in particular, by the IMU Secretariat in the organization of this year’s virtual activities.

3.5 Overview of Events | 2020 and Beyond



Meeting of the IMU Executive Committee, February 22–23, 2020. The second annual meeting of the 2019–2022 IMU EC was hosted at the African Institute for Mathematical Sciences (AIMS) in Cape Town, South Africa. A priority for the meeting was the IMU EC’s selection of members for a number of IMU prize committees, the review of the progress made in the planning and delivery of ICM 2022, as well as recurring business. The meeting was supported administratively and attended by IMU Secretariat staff members.

Participants: Carlos E. Kenig, Helge Holden, Nalini Joshi, Loyiso G. Nongxa, Luigi Ambrosio, Andrei Okounkov, Paolo Piccione, R.T. Ramadas, Gang Tian, Günter M. Ziegler, Shigefumi Mori, Alexander Mielke, Kerstin Jordaan, Via Skype: Martin Hairer, Stanislaw Smirnow.

Photo: Rene January, AIMS

"Mathematics is Everywhere" The International Day of Mathematics (IDM), March 14, 2020. The theme for the inaugural IDM in 2020 was "Mathematics is Everywhere". The launch was switched to a global online event, with activities and events taking place throughout the day worldwide, shared via live updates and videos on the IDM website. The theme for IDM 2021 will be "Mathematics for a Better World".



Meeting of the ICMI General Assembly, July 13, 2020 | ICMI Executive Committee Meeting, September 9–11, 2020, hosted online by the IMU Secretariat.

ICMI General Assembly Participants: ICMI Executive Committee members, IMU Secretariat and over 50 Country Representatives from around the world.

ICMI Executive Committee Meeting Participants: ICMI Executive Committee members and invited guests.

Meeting of the Scientific Advisory Board of WIAS, September 18, 2020. The September meeting of the Scientific Advisory Board of WIAS was hosted in the conference room of the IMU Secretariat.

Guests at the Secretariat. Historian Nobert Schappacher did research in the IMU Archive (February 4 and September 24). Former IMU Secretary Martin Grötschel visited the IMU Secretariat on several occasions in Autumn 2020 to finalize the archiving of materials from the time of his tenure as IMU Secretary.

Prominent Events Postponed to 2021

ICME–14. *International Congress on Mathematical Education*, Shanghai, China, July 11–18, 2021.

Mathematics without Borders. *The Centennial of the International Mathematical Union*, Strasbourg, France, September 27–28, 2021. The IMU was officially founded on September 20, 1920, in Strasbourg, just prior to the International Congress of Mathematicians in Strasbourg. The conference will celebrate the centennial of this historic event. The opening of the conference will take place in the same building used for the ICM 1920.

Poster design by C. Angwin

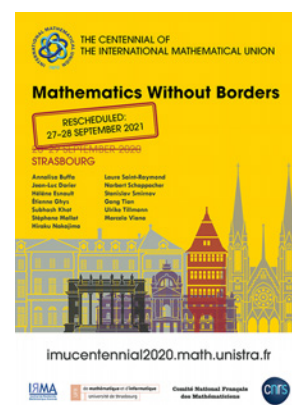

4 Research Groups' Essentials

- RG 1 *Partial Differential Equations*
- RG 2 *Laser Dynamics*
- RG 3 *Numerical Mathematics and Scientific Computing*
- RG 4 *Nonlinear Optimization and Inverse Problems*
- RG 5 *Interacting Random Systems*
- RG 6 *Stochastic Algorithms and Nonparametric Statistics*
- RG 7 *Thermodyn. Modeling and Analysis of Phase Transitions*
- RG 8 *Nonsmooth Variational Probl. and Operator Equations*

4.1 Research Group 1 "Partial Differential Equations"

Head:	Prof. Dr. Alexander Mielke
Deputy Head:	Dr. Matthias Liero
Team:	Dr. Pierre-Étienne Druet Dr. Thomas Eiter Priv.-Doz. Dr. Annegret Glitzky Dr. Martin Heida Dr. Katharina Hopf Dr. Hans-Christoph Kaiser Dr. Thomas Koprucki Anieza Maltsi Dr. Oliver Marquardt Dr. Grigor Nika Dr. Petr Pelech Dr. Joachim Rehberg Stefanie Schindler Artur Stephan
Secretary:	Andrea Eismann
Nonresident Members:	Prof. Dr. Konrad Gröger Prof. Dr. Jürgen Sprekels

The mathematical focus of this research group is on the analytical understanding of partial differential equations and their usage for the modeling in the sciences and in engineering. The theory is developed in connection with well-chosen problems in applications, mainly in the following areas:

- Modeling of semiconductors; in particular, organic semiconductors and optoelectronic devices
- Reaction-diffusion systems, also including temperature coupling
- Nonlinear material models, in particular, elastoplasticity

The methods involve topics from pure functional analysis, mathematical physics, pure and applied analysis, calculus of variations, and numerical analysis with special emphasis on

- Qualitative methods for Hamiltonian systems, gradient flows, or consistently coupled systems
- Multiscale methods for deriving effective large-scale models from models on smaller scales, including models derived from stochastic particle systems
- Existence, uniqueness, and regularity theory for initial and boundary value problems in non-smooth domains and with nonsmooth coefficients, thereby also including nonlocal effects

The qualitative study of partial differential equations provides a deeper understanding of the underlying processes and is decisive for the construction of efficient numerical algorithms. Corresponding scientific software tools are developed in cooperation with other research groups.

We mourn the loss of our nonresident group and honorary institute members Herbert Gajewski (July 13, 1939 – December 11, 2019) and Konrad Gröger (April 11, 1936 – September 14, 2020). Herbert Gajewski was deputy director of the Weierstrass Institute and head of RG 1 until his retirement in 2004. Konrad Gröger was a member of the institute until he left for a professorship for Analysis at Humboldt-Universität zu Berlin in 1990, but always remained associated with the institute.

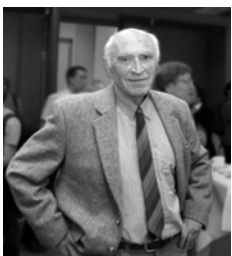

Fig. 1: Herbert Gajewski
(July 13, 1939 –
December 11, 2019)

Herbert Gajewski and Konrad Gröger left a rich scientific legacy including crucial and internationally renowned contributions to the theory of partial differential equations and their applications in mechanics, thermodynamics, chemical kinetics, and semiconductor physics. Both actively participated in the Berlin Seminar on Nonlinear Partial Differential Equations (Langenbach seminar). We will honour their memory.

Partial differential equations and regularity

This field of research provides the basic research for the analytical treatment of coupled systems of nonlinear partial differential equations arising in different applications, e.g., in natural sciences, technology, economy, and life science. The results of the group include, e.g., regularity theory for elliptic and parabolic operators, variational methods for evolutionary systems, generalized gradient systems, entropy methods, and generalized solution concepts.

Optimal sector for divergence operators. The passage from the Hilbert space L^2 to the Banach space L^p is often an adequate instrument for the treatment of nonlinear parabolic equations. In many practical situations, nonsmoothness of the underlying domain and coefficient functions as well as *mixed* boundary conditions have to be taken into account. For an advanced treatment of parabolic equations, the generator property of an analytic semigroup is a necessary tool, in other words: One needs a suitable decay of the resolvent. Such resolvent estimates were proved explicitly in [4] on all L^p spaces, $p \in (1, \infty)$, in terms of the coefficient function μ , which is supposed to be real, bounded, and elliptic, but not necessarily symmetric. These estimates are optimal in general, as examples show. *No* conditions on the domain and on the Dirichlet boundary part are required at all. Moreover, the considerations are not restricted only to the case when the corresponding measure lives “on the volume” of the domain, but includes the case where it has a non-trivial part living on sets of codimension 1. This even allows to consider *dynamic* boundary conditions.

Multicomponent fluid dynamics. In cooperation with the Technische Universität Darmstadt, important results concerning the modeling and analysis of multicomponent flow problems were achieved: A new closure scheme for multicomponent diffusion fluxes with the correct scaling of thermodynamic diffusivities was developed and used to rigorously prove the equivalence of the Maxwell–Stefan and the Fick–Onsager closure approaches. The existence of weak solutions for the full equations describing the flow of compressible ideal mixtures by general thermodynamic potential was proved. Moreover, new equations for incompressible liquid mixtures in the low Mach-number limit were obtained, and their local-in-time well-posedness was established.

Analysis and modeling of semiconductor devices

In this field, RG 1 cooperates with RG 2 *Laser Dynamics*, RG 3 *Numerical Mathematics and Scientific Computing*, and LG 5 *Numerical Methods for Innovative Semiconductor Devices*. In 2020, group members could acquire the two subprojects “Electro-mechanical coupling for semiconductor devices” (with LG 5 and Barbara Zwicknagl from Humboldt-Universität zu Berlin) and “Random alloy fluctuations in semiconductors” (with RG 6 *Stochastic Algorithms and Nonparametric Statistics*) starting January 2021 within the Berlin Mathematics Research Center MATH+.



Fig. 2: Konrad Gröger
(April 11, 1936 –
September 14, 2020)

Data-driven electronic structure calculations for nanostructures. The focus of MATH+ subproject AA2-5 “Data-driven electronic structure calculation in nanostructures (DESCANT)” was on extracting electronic band structure parameters for multiband $\mathbf{k} \cdot \mathbf{p}$ models from *ab initio* data. Models based on $\mathbf{k} \cdot \mathbf{p}$ perturbation theory represent the backbone of modern device modeling. However, the typical limitation of eight-band $\mathbf{k} \cdot \mathbf{p}$ models to the top three valence bands and the lowest conduction band makes them unsuitable for a number of novel materials where additional bands play a decisive role, such as GaAs in the metastable wurtzite (WZ) phase or indirect-gap semiconductors. To address these issues, a 16-band $\mathbf{k} \cdot \mathbf{p}$ model was developed in collaboration with Morten Willatzen (Lyngby and Beijing), which takes the following four conduction bands into account. The project was successfully completed by the development of a novel fitting scheme based on low-discrepancy point sequences, which was designed together with Peter Mathé (RG 6), to extract material parameters from up-to-date *ab initio* data. The scheme allows to assign priorities to selected bands or specific areas of the Brillouin zone as well as to evaluate ellipticity criteria to avoid unphysical band behavior. The fitting scheme was employed to extract the 25 independent material parameters required for the description of WZ GaAs in the 16-band model and yields an excellent agreement with the *ab initio* band structure computed by Miguel Caro (Aalto), to which it was fitted. The scheme can be directly applied to other material systems or Hamiltonians based on other basis sets.

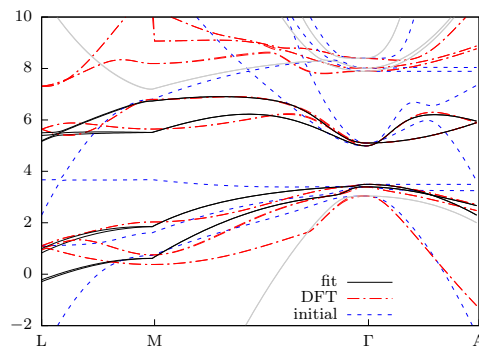

Fig. 3: Best-fit band structure of WZ GaAs within a 16-band $\mathbf{k} \cdot \mathbf{p}$ model (black and gray solid) compared to the original band structure computed from density functional theory (red dashed). Priority was given to the two valence and conduction bands closest to the band gap (black). The blue dash-dotted line indicates the initial guess used for the fitting scheme; see [1].

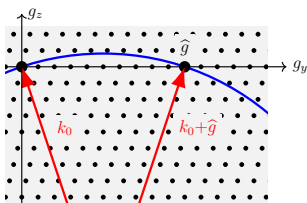

Fig. 4: Two-beam approximation: Only the incoming beam k_0 and $k_0 + \hat{g}$ are considered

Model-based geometry reconstruction from TEM images. The MATH+ subproject EF3-1, jointly with RG 6 *Stochastic Algorithms and Nonparametric Statistics*, deals with the geometry reconstruction of semiconductor quantum dots from transmission electron microscopy (TEM) images. The Darwin–Howie–Whelan equations are commonly used to describe and simulate the scattering of electrons in TEM. They are a system of infinitely many envelope functions, derived from the Schrödinger equation. However, for the simulation of TEM images only a finite set of envelope functions is used, leading to a system of ordinary differential equations in thickness direction of the specimen. Usually, heuristic rules are employed to select the relevant beams, e.g., by thresholds for the excitation error. In EF3-1, the mathematical structure of this system was studied and error estimates to evaluate accuracies of special approximations, like two-beam and systematic-row approximations, were provided [5].

Improved models for heat and charge flow in organic devices. The MATH+ subproject AA2-1 “Hybrid models for the electrothermal behavior of organic semiconductor devices” was successfully

completed. The focus of the project was on the derivation and mathematical analysis of improved models for the description of self-heating effects due to charge flow in organic semiconductor devices studied by our partners at the Dresden Integrated Center for Applied Physics and Photonic Materials (IAPP). Hybrid models were derived and analyzed, with the aim of tailoring high accuracy and computational efficiency. Moreover, a rigorous dimension reduction of a $p(x)$ Laplace thermistor model for large-area organic LEDs was performed for vanishing layer thickness [2].

Material modeling

The research on this topic is done in cooperation with RG 5 *Interacting Random Systems* and the WG 1 *Modeling, Analysis and Scaling Limits for Bulk-Interface Processes* and was driven by subprojects of the DFG Collaborative Research Center CRC 1114 *Scaling Cascades in Complex Systems*. In the second period of CRC 1114, the group participates with three subprojects: B01 (with Freie Universität (FU) Berlin and GeoForschungsZentrum Potsdam), C02 (with FU Berlin), and C05 (WIAS only). RG 1 acquired two subprojects in the newly established DFG Priority Program SPP 2256 *Variational Methods for Predicting Complex Phenomena in Engineering Structures and Materials*, namely “Fractal and stochastic homogenization using variational techniques” and “Analysis for thermo-mechanical models with internal variables”.

EDP convergence for nonlinear fast-slow reaction systems. In subproject C05 of CRC 1114, dissipative systems are studied that can be described by a gradient-flow equation with respect to an energy functional and a dissipation structure. The solutions for these equations can be characterized variationally using the energy-dissipation principle (EDP), which gives rise to a notion of convergence for gradient systems, called *EDP convergence*.

The reaction-rate equation for chemical reactions satisfying the mass-action law can be described as the gradient-flow equation if the detailed balance condition holds. Hence, the theory of EDP convergence could be applied to fast-slow reaction systems, which led to new effective reaction-rate equations on a coarse-grained state space, where the original Boltzmann entropy is replaced by a more general mixing entropy and the mass-action law is also generalized.

Elasticity on randomly perforated domains. In subproject C05 of CRC 1114, the homogenization of partial differential equations on randomly perforated domains was studied in detail. For the first time uniform compactness for solutions of homogenization problems on domains with percolating holes and “bad” local regularity was derived in [3]. In contrast, results in the literature up to now only dealt with bounded perforation holes with uniform regularity assumptions on the geometry. The results provide a basis for further generalization of standard embeddings and inequalities to random geometries.

Further highlights of 2020

Awards and distinctions. Katharina Hopf was awarded the *Faculty of Science Thesis Prize in Mathematics* at the University of Warwick for her Ph.D. thesis. Oliver Marquardt is among the finalists of the *Rising Stars in Computational Materials 2020* Award.

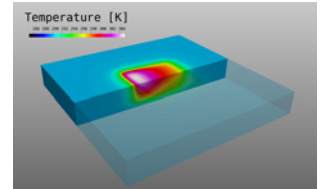

Fig. 5: Temperature increase due to self-heating in large-area organic light-emitting diode on glass substrate

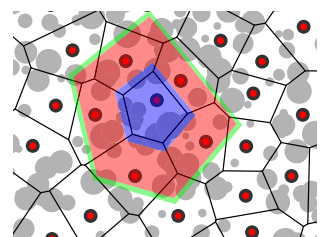

Fig. 6: Construction of macroscopic extension operators for randomly perforated domains using Voronoi tessellations

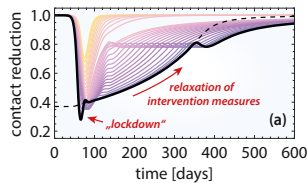

Fig. 7: Optimal control of the COVID-19 pandemic



Fig. 8: Photo by Katrin Schmid, Copyright: MFO

Flattening the curve. On the basis of a simple epidemiological model and continuous-time optimal control theory, Markus Kantner (RG 2) and Thomas Koprucki (RG 1) computed the optimal, non-pharmaceutical intervention strategy for transmission reduction for the case where no vaccine becomes available and the complete containment of the coronavirus is not possible.

Severely Disabled Persons in the Leibniz Association. On December 17, 2020, the representative for disabled employees at WIAS, Hans-Christoph Kaiser, hosted the Fifth Meeting of the network of representative bodies for disabled employees at Leibniz institutions, for which WIAS provided the online conference platform. Dr. Ricarda Opitz, Deputy Secretary General of the Leibniz Association, appreciated in her welcoming speech the campaign of the network for equal opportunities and greater transparency regarding the situation of severely disabled employees in the Leibniz Association. Training courses addressed challenges of the COVID-19 pandemic for the work of representative bodies for disabled employees at Leibniz institutions.

Oberwolfach and MA4M workshop. The hybrid workshop “Variational Methods for Evolution”, organized by Alexander Mielke, Mark Peletier (Eindhoven), and Dejan Slepcev (Pittsburgh), took place September 13–19. Continuing the successful line of meetings (after 2011, 2014, and 2017), participants discussed variational principles for evolutionary systems, which allow for the usage of the rich toolbox provided by the theory of the calculus of variations.

Within the Thematic Einstein Semester on “Energy-based Mathematical Methods for Reactive Multiphase Flows” (see the Scientific Highlights article on page 36), the workshop “Mathematical Analysis for Mechanics” (MA4M) was jointly organized by Matthias Liero and Alexander Mielke (RG 1) and Marita Thomas (WG 1). The online workshop took place November 23–25 and was devoted to recent aspects of the analysis of mathematical problems arising in the continuum mechanics of solids and fluids.

References

- [1] O. MARQUARDT, M.A. CARO, T. KOPRUCKI, P. MATHÉ, M. WILLATZEN, *Multiband $\mathbf{k}\cdot\mathbf{p}$ model and fitting scheme for ab initio based electronic structure parameters for wurtzite GaAs*, Phys. Rev. B, **101** (2020), pp. 235147/1–235147/12.
- [2] A. GLITZKY, M. LIERO, G. NIKA, *Dimension reduction of thermistor models for large-area organic light-emitting diodes*, Discrete Contin. Dyn. Syst. Ser. S, 19 pages, published online on 19.11.2020, <https://doi.org/10.3934/dcdss.2020460>.
- [3] M. HEIDA, *Stochastic homogenization on randomly perforated domains*, WIAS Preprint no. 2742, 2020.
- [4] R. CHILL, H. MEINLSCHMIDT, J. REHBERG, *On the numerical range of second order elliptic operators with mixed boundary conditions in L^p* , J. Evol. Equ., 22 pages, published online on 20.10.2020, <https://doi.org/10.1007/s00028-020-00642-6>.
- [5] T. KOPRUCKI, A. MALTSI, A. MIELKE, *On the Darwin–Howie–Whelan equations for the scattering of fast electrons described by the Schrödinger equation*, WIAS Preprint no. 2802, 2020.

4.2 Research Group 2 “Laser Dynamics”

Head:	Priv.-Doz. Dr. Uwe Bandelow
Deputy Head:	Dr. Matthias Wolfrum
Team:	Dr. Shalva Amiranashvili Alexander Gerdes Dr. Markus Kantner Dr. Alexander Pimenov Dr. Mindaugas Radziunas Mina Stöhr Dr. Andrei G. Vladimirov Dr. Hans-Jürgen Wünsche
Secretary:	Laura Wartenberg

The research of this group is devoted to the study of mathematical problems that appear in non-linear optics and optoelectronics. The research activities include mathematical modeling, theoretical investigation of fundamental physical effects, implementation of numerical methods, efficient modeling and simulation of complex devices, and the development of related mathematical theory, mainly in the field of *dynamical systems*. The research is mainly devoted to the application-oriented research topics *dynamics of semiconductor lasers* and *pulses in nonlinear optical media* and contributes to the WIAS core expertise in *Modeling and Simulation of Semiconductor Devices*.

In 2020, external funding was received within the DFG Collaborative Research Center 910 *Control of Self-organizing Nonlinear Systems: Theoretical Methods and Concepts of Application*, subproject A3 “Self-organization and control in coupled networks and time-delayed systems” and the project AA2-3 “Quantum-classical simulation of quantum dot nanolasers” within the Cluster of Excellence MATH+. At the end of 2020, the research group also started working on a research and development project with Ferdinand Braun Institute for High-Frequency Technology (FBH), seeking a better characterization of the calculated multisection laser emission linewidth.

Moreover, in 2020, the comprehensive compendium “Semiconductor Nanophotonics: Materials, Models and Devices” was published by the former members of the DFG Collaborative Research Center CRC 787. The book summarizes the highlights of the twelve successful years of funding (2008–2019). The RG 2 headed the projects B4 “Multi-dimensional modeling and simulation of electrically pumped semiconductor-based emitters” (jointly with RG 1 *Partial Differential Equations* and Zuse Institute Berlin) and B5 “Effective models, simulation and analysis of the dynamics in quantum-dot devices” and contributed to four chapters of the book (including [1]).

The planned workshops “Nonlinear Dynamics in Semiconductor Lasers” (NDSL 2020) and “Applied Mathematics and Simulation for Semiconductors and Electrochemical Systems” (AMaSiS 2020, together with RG 1, RG 3 *Numerical Mathematics and Scientific Computing*, and RG 7 *Thermodynamic Modeling and Analysis of Phase Transitions*), unfortunately, had to be canceled on short notice due to the COVID-19 pandemic and were postponed to 2021.

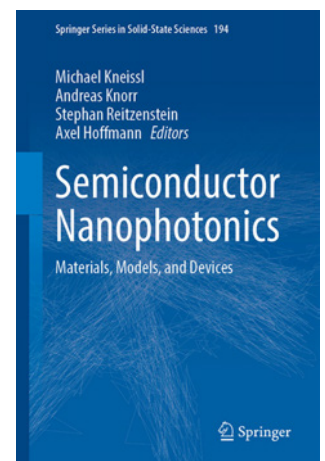

Dynamics of semiconductor lasers

Low-noise optical frequency combs. Low-noise optical frequency combs generated by ultra-short pulse mode-locked lasers have revolutionized fields of science and technology, such as high-precision spectroscopy, metrology, and photonic analog-to-digital conversion. In particular, the novel dual-comb spectroscopy characterized by significantly enhanced precision, sensitivity, and speed traditionally requires two mode-locked, fully stabilized lasers with complex feedback electronics. Very recently, an alternative approach to produce dual optical frequency combs was proposed based on a single laser emitting two orthogonally polarized interlaced pulses with slightly different repetition frequencies. Based on the spin-flip model, the research group proposed and studied numerically a system of delay-differential equations describing a generation of two orthogonally polarized frequency combs in a mode-locked vertical external-cavity surface-emitting laser (VECSEL) [2]. The two combs generated are shifted in wavelength due to the birefringence in the gain section and saturable absorber mirror. It was shown that apart from dual-comb fundamental mode-locking regimes, this laser can generate several pulses per round trip as well as more complicated dynamics with two linear polarizations excited, see Figure 1.

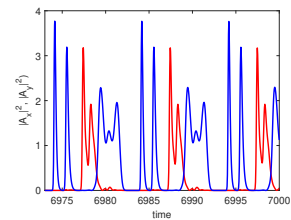

Fig. 1: Intensity time traces of x - (red) and y - polarized (blue) mode-locked pulses obtained by numerical simulation of the DDE VECSEL model

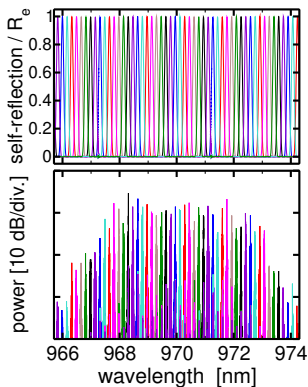

Fig. 2: Top: self-reflection spectra for eight coupled diodes. Bottom: simulated optical spectra of the emission of these diodes.

Delay-differential equation model for temporal cavity solitons. Delay-differential equation (DDE) modeling approaches have proven to be a very powerful tool for studying short pulse generation in multimode lasers and optical cavities. An important issue in this approach is the inclusion of chromatic dispersion of the intracavity media into consideration, one of the principal factors affecting the pulse characteristics. In [3], RG 2 has developed an efficient method for the bifurcation analysis of dispersive time-delay models of optical systems that was previously only available for envelope partial differential equations (PDEs). Using this approach, a formation of the so-called *temporal cavity solitons* in a model of an optically injected ring cavity laser containing a semiconductor gain medium and long fiber delay line was studied. Being much simpler than the distributed DDE laser model developed in earlier works, the reduced equations developed in [3] can become a useful tool for studying the effect of chromatic dispersion on the dynamics of different types of optoelectronic devices, and, in particular, mode-locked semiconductor lasers.

High-power broad-area edge-emitting semiconductor lasers. Together with colleagues from FBH and RG 3 *Numerical Mathematics and Scientific Computing* (Jürgen Fuhrmann, Holger Stephan), RG 2 has further considered the properties of various high-power broad-area edge-emitting semiconductor laser (BAL) structures [4] using the recently extended version of the WIAS software BALaser. Together with the partners of the Eurostars project “HIP-Lasers” that expired in 2019, Monocrom (Vilanova, Spain) and Raab-Photonik GmbH (Potsdam), the research group continued the study of efficient polarization beam combining of 2^n diodes coupled by a cascaded external cavity containing multiple Lyot filters within it. The constructed external cavities could provide optimal mutually-interleaving wavelength filtering of the feedback to individual emitters (upper panel of Figure 2). It was shown both theoretically and experimentally that the laser mode selection induced by such feedback could lead to a nice interleaving of the optical spectra combs of these emitters (lower panel of Figure 2), which in turn could guarantee high efficiency of the beam combining. For more details, see the Scientific Highlights article of RG 2 in this annual report on page 14 and the references therein.

Self-heating and thermoelectric effects in semiconductors. Many challenges faced in the development of optoelectronic devices are related to self-heating phenomena, which become increasingly important with the on-going miniaturization of the device's feature size. The spatio-temporal dynamics of charge and heat transfer in semiconductor devices are well-described by the non-isothermal drift-diffusion system. A new formulation of the non-isothermal drift-diffusion system based on a new approximation of the Seebeck coefficient [5] was developed, which describes the magnitude of the thermoelectric cross-effects. The corresponding system of partial differential equations is derived from a free energy model, which ensures the consistency with fundamental principles of non-equilibrium thermodynamics. For numerical simulations, RG 2 devised a novel generalization of the finite-volume Scharfetter–Gummel method that guarantees all important structural properties of the continuous system on the discrete level. Moreover, it is more accurate than traditional approaches. The research was funded by the Cluster of Excellence MATH+ (project AA2-3).

Pulses in nonlinear optical media

Optical pulses in fibers, including even the most robust optical solitons, are subject to slow but unstoppable degradation processes. The reasons may vary from the trivial attenuation to the involved “soliton self-frequency shift” (SSFS), but anyway, the pulses have to be supported by an external energy source. The review paper [6] discusses applications of the so-called *optical event horizons*, which have been studied in RG 2 for several years, to the stabilization of SSFS. As it happens, the stabilization scheme itself can be stable or unstable, and the necessary conditions for, so to speak, a stable stabilization were determined.

Another direction of research was a robust derivation of the simplified model equations for optical elements. The research group took advantage of two mathematical techniques: Laplace transform and Padé approximants [3]. The derived models save a lot of computing time; moreover, they were found to be compatible with the fundamental physical restriction of causality. The compatibility is most welcome, even though there was no understandable reason for its presence, which is why it will be the subject of further investigations.

Theory of dynamical systems

The mathematical research on Dynamical Systems provides the theoretical background for the applied topics in optoelectronics and nonlinear optics of RG 2. Ongoing work within the Collaborative Research Center 910 is related to temporal dissipative solitons in delay-differential equations and collective dynamics in large coupled systems. In addition, the mathematical expertise could be used for a contribution concerning the dynamics of the COVID-19 pandemic.

Modeling and optimal control of the COVID-19 pandemic. The public debate about the management of the COVID-19 pandemic is dominated by a controversial debate on the balance of saved lives vs. the socio-economic costs caused by non-pharmaceutical interventions (“lockdown”). Especially in the early stages, the “herd immunity strategy” was critically discussed and initially assessed very differently by several governments. In order to estimate the consequences of this strat-

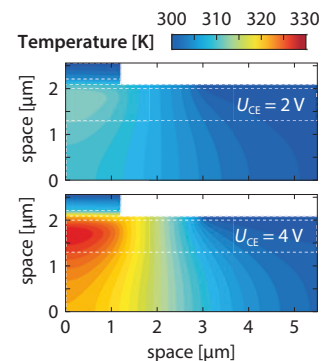
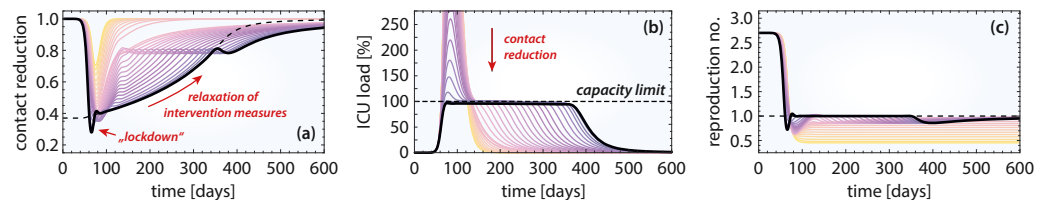

Fig. 3: Simulation of self-heating in semiconductor devices

egy, a simple compartmental model (generalized *Susceptible-Exposed-Infected-Recovered model*) tailored to specific aspects of the COVID-19 pandemic was developed, which was calibrated to reproduce the early exponential growth phase in Germany [7]. On the basis of Pontryagin's maximum principle, the optimal time-resolved mean contact reduction rate (i.e., temporal course of the effective reproduction number) for an optimal route to herd immunity via natural infections was computed. The obtained control policy minimizes the number of disease-related deaths at minimal socio-economic costs, while avoiding an overflow of the available intensive care units (ICUs) at any time. A careful analysis of the result reveals, however, that the obtained optimal solution is in fact a tightrope walk close to the stability boundary of the system, which is either highly dangerous (in terms of health risk) or very expensive. In conclusion, it is strongly advisable to consider other control policies (e.g., reduction of incidence to a level that is manageable for case tracking, local eradication of the epidemic).

Fig. 4: Optimal control of the COVID-19 pandemic. (a) Mean contact reduction rate, (b) ICU load, (c) effective reproduction number. See Ref. [7] for details.



References

- [1] M. KANTNER, T. HÖHNE, T. KOPRUCKI, S. BURGER, H.-J. WÜNSCHE, F. SCHMIDT, A. MIELKE, U. BANDELOW, *Multi-dimensional modeling and simulation of semiconductor nanophotonic devices*, in: *Semiconductor Nanophotonics*, M. Kneissl, A. Knorr, S. Reitzenstein, A. Hoffmann, eds., Springer, 2020, Chap. 7, pp. 241–283.
- [2] A.G. VLADIMIROV, K. PANAJOTOV, M. TLIDI, *Orthogonally polarized frequency combs in a mode-locked VECSEL*, *Opt. Lett.*, **45** (2020), pp. 252–255.
- [3] A. PIMENOV, S. AMIRANASHVILI, A.G. VLADIMIROV, *Temporal cavity solitons in a delayed model of a dispersive cavity ring laser*, *Math. Model. Nat. Phenom.*, **15** (2020), pp. 47/1–47/18. Open Access: <https://www.mmnp-journal.org/articles/mmnp/abs/2020/01/mmnp180202/mmnp180202.html>
- [4] J.-P. KOESTER, A. PUTZ, H. WENZEL, H.-J. WÜNSCHE, M. RADZIUNAS, H. STEPHAN, M. WILKENS, A. ZEGHUZI, A. KNIGGE, *Mode competition in broad-ridge-waveguide lasers*, *Semicond. Sci. Technol.*, **36**:1 (2020), pp. 015014/1–015014/12. Open Access: <https://iopscience.iop.org/article/10.1088/1361-6641/abc6e7>
- [5] M. KANTNER, *Generalized Scharfetter–Gummel schemes for electro-thermal transport in degenerate semiconductors using the Kelvin formula for the Seebeck coefficient*, *J. Comput. Phys.*, **402** (2020), pp. 109091/1–109091/24.
- [6] U. BANDELOW, S. AMIRANASHVILI, S. PICKARTZ, *Stabilization of optical pulse transmission by exploiting fiber nonlinearities*, *J. Lightwave Technol.*, **38** (2020), pp. 5743–5747.
- [7] M. KANTNER, T. KOPRUCKI, *Beyond just “flattening the curve”: Optimal control of epidemics with purely non-pharmaceutical interventions*, *J. Math. Ind.*, **10** (2020), pp. 23/1–23/23.

4.3 Research Group 3 “Numerical Mathematics and Scientific Computing”

Head:	Prof. Dr. Volker John
Deputy Head:	Dr. Jürgen Fuhrmann
Team:	Dr. Laura Blank Priv.-Doz. Dr. Alfonso Caiazzo Prof. Dr. Wolfgang Dreyer Derk Frerichs Dr. Abhinav Jha René Kehl Dr. Zahra Lakdawala Priv.-Doz. Dr. Alexander Linke Dr. Christian Merdon Dr. Baptiste Moreau Dr. Ondřej Pártl Dr. Hang Si Dr. Holger Stephan Timo Streckenbach Dr. Petr Vagner Dr. Ulrich Wilbrandt
Apprentices:	Marko Jahn Mihaela Karcheva Leo Markmann
Secretary:	Marion Lawrenz

RG 3 studies the development of numerical methods, their numerical analysis, and it works at implementing software for the numerical solution of partial differential equations (PDEs). Many of the research topics have been inspired by problems from applications. Several research topics of the group are briefly described below. Further topics include physically consistent discretizations for flow equations, see the Scientific Highlights article on page 19 and numerical methods for applications from medicine. In addition, the group organizes vocational training for mathematical-technical software developers.

Analysis of algebraic stabilizations for evolutionary problems

Algebraically stabilized discretizations belong to the very few classes of finite element methods for transport-dominated problems that both satisfy discrete maximum principles and compute sharp layers. In these methods, so-called *algebraic fluxes* and corresponding limiters are defined, with the limiters depending on the discrete solution. Consequently, the arising discrete problems are nonlinear. First results on the numerical analysis of algebraic stabilizations for steady-state convection-diffusion equations were published only five years ago. Meanwhile, results are available concerning the existence of a solution, the order of convergence, and the satisfaction of discrete maximum principles. For the evolutionary case, where these discretizations are called *flux-corrected transport (FCT) schemes*, the first analytic results have been obtained only recently.

In [4], the existence of a solution for arbitrary time steps is shown. The proof is based on a version of Brouwer's fixed-point theorem. General requirements on the limiters are derived such that the resulting scheme satisfies the assumptions of this theorem. It is shown that a standard limiter, the so-called *Zalesak limiter*, meets these requirements.

Paper [5] proves the existence and uniqueness of a solution of the nonlinear problem for sufficiently small time steps. Here, the analysis is based on the implicit function theorem for Lipschitz functions. The nonlinear problem is written as implicit function. One assumption of the implicit function theorem is satisfied because this problem possesses a solution for vanishing length of the time step, namely the starting point of the current time step. Thus, the main tasks were to show that the implicit function is locally Lipschitz continuous and that a generalized derivative is non-singular. These properties could be proved for a variant of the Zalesak limiter. Finally, it is shown that the semi-smooth Newton's method converges locally at quadratic rate.

Finite volume methods for drift-diffusion problems in semiconductor devices and electrochemical systems

Charge transport in electrolytes and semiconductor devices is modeled using drift-diffusion equations in a self-consistent electric field. The Voronoi box based finite volume method provides a space discretization that allows to transfer a number of important physical properties of the continuous problem to the discretized one. These properties include consistency to the thermodynamic equilibrium, positivity of concentrations, and decay of the relative free energy during time evolution. In addition, various models of strongly degenerate semiconductors, electrolytes with volume constraints, ionic liquids, and solid electrolytes exhibit an upper bound for charge carrier concentrations that should be reflected as well in the discretized system. Several approaches of flux discretizations for strongly degenerated drift-diffusion problems have been compared. Joint investigations with LG 5 *Numerical Methods for Innovative Semiconductor Devices* and the group of Claire Chainais-Hilliaret (Lille) resulted in a rather profound understanding of the advantages and disadvantages of different flux approximation schemes. In particular, it was possible to prove the above-mentioned qualitative properties. For two of the schemes even convergence could be shown [1].

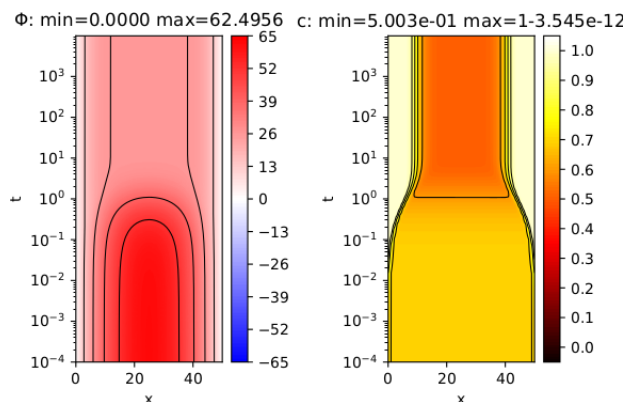

Fig. 1: Time evolution of electrostatic potential (left) and anion concentration (right) in a closed electrochemical cell [1], calculated using the Julia package *VoronoiFVM.jl*

In cooperation with RG 1 *Partial Differential Equations*, the finite volume discretization approach for degenerate semiconductors was extended with a path-following approach, allowing for numerical simulations that give hints for the existence of negative differential resistance in a non-isothermal drift-diffusion model of an organic semiconductor [2], resulting in an S-shaped current-voltage dependency.

PDELib.jl: Software components for the numerical solution of partial differential equations in Julia

In recent years, in particular since the release of version 1.0, the Julia programming language gained significant momentum in fields related to scientific computing and data science. Taking advantage of accumulated experience and know-how in language design, designed around the just-in-time compilation paradigm, and featuring first-class multi-dimensional array handling, it allows for the implementation of complex numerical algorithms without sacrificing efficiency.

These features and its powerful and easy-to-access support for generic programming (“multiple dispatch”) set Julia apart from scripted languages like Matlab or Python, where high performance can be achieved only via reformulation of algorithms based on vector operations or by calling into computational kernels implemented in a compiled language. Compared to C++, Julia has a significantly simpler syntax without sacrificing performance. Another outstanding feature of Julia is its package manager that allows easy installation of Julia packages and at the same time enables to keep track of the exact code versions used to establish a particular simulation result.

The multiple dispatch paradigm, in particular, allows for an efficient and easy-to-handle implementation of automatic differentiation (AD) in Julia. Code design studies by RG 3 have shown that AD allows to significantly simplify the implementation of numerical methods for nonlinear systems of PDEs. This observation led to the decision to transfer the know-how on numerical methods and visualization accumulated in the C++/Python-based PDE simulation toolbox `pdelib`, maintained by the group, to Julia in the form of a group of open source Julia packages for handling grids (`ExtendableGrids.jl`, `SimplexGridFactory.jl`), sparse matrices (`ExtendableSparse.jl`), and visualization (`GridVisualize.jl`). In addition, the group co-maintains the mesh generator interfaces `Triangulate.jl` and `TetGen.jl`.

The Julia package `VoronoiFVM.jl` implements the Voronoi box based finite volume method, like its C++ based predecessor `PDELIB/FVSYS`. Much simpler syntax and AD instead of hand-written implementation of derivatives allows for a simple and concise application programming interface (API) to implement complex nonlinear diffusion-convection-reaction systems. The package has been successfully used in [1] (see also Figure 1) and in several submitted papers in cooperation with LG 5 and RG 7 *Thermodynamic Modeling and Analysis of Phase Transitions* in the field of electrochemistry and semiconductor modeling.

`GradientRobustMultiPhysics.jl` offers (currently mainly low-order) finite element methods (H1, Hdiv, Hcurl) with a focus on gradient-robust discretizations for multi-physics problems in computational fluid dynamics. For a comprehensive overview on this type of methods see the Scientific Highlights article on page 19. The package utilizes AD to obtain shape function derivatives and to handle model nonlinearities.

Fig. 2: Stationary Kármán flow calculated with Bernadi–Raugel mixed finite elements and gradient robust stabilization, computed using the Julia package

`GradientRobustMultiPhysics.jl`

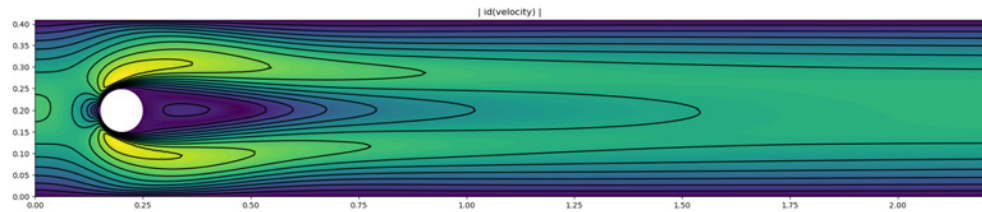

All mentioned Julia packages are bundled by the open source meta-package `PDELib.jl` [3]. The integration with the Julia ecosystem will allow to access and utilize a wide range of methods implemented in other Julia packages like accurate transient solvers, bifurcation analysis, machine learning, optimization, providing a rich base for future application projects of the group.

Tetrahedral mesh generation

Based on recent research on fundamental algorithms for the generation of tetrahedral meshes, the new version 1.6 of the successful tetrahedral mesh generator `TetGen` has been published [6]. Improvements with respect to the preceding release include increased performance of the Bowyer–Watson point insertion algorithm for creating Delaunay tetrahedralizations, a more robust boundary recovery algorithm for creating constrained tetrahedralizations, and new algorithmic approaches for better mesh quality.

`TetGen` is available either as open source under the Affero GNU Public license, or under a paid commercial license.

References

- [1] C. CANCEËS, C. CHAINAIS-HILLAIRET, J. FUHRMANN, B. GAUDEUL, *A numerical-analysis-focused comparison of several finite volume schemes for a unipolar degenerate drift-diffusion model*, IMA J. Numer. Anal., **41** (2021), pp. 271–314.
- [2] D.H. DOAN, A. FISCHER, J. FUHRMANN, A. GLITZKY, M. LIERO, *Drift-diffusion simulation of S-shaped current-voltage relations for organic semiconductor devices*, J. Comput. Electron., **19** (2020), pp. 1164–1174.
- [3] J. FUHRMANN ET AL., *Software components for the numerical solution of partial differential equations in Julia*, <https://github.com/WIAS-BERLIN/PDELib.jl>.
- [4] V. JOHN, P. KNOBLOCH, *Existence of solutions of a finite element flux-corrected transport scheme*, Appl. Math. Lett., **115** (2021), pp. 106932/1–106931/6.
- [5] V. JOHN, P. KNOBLOCH, P. KORSMEIER, *On the solvability of the nonlinear problems in an algebraically stabilized finite element method for evolutionary transport-dominated equations*, Math. Comp., **90** (2021), pp. 595–611.
- [6] H. SI, *A Quality Tetrahedral Mesh Generator and a 3D Delaunay Triangulator. Version 1.6*, <https://wias-berlin.de/software/index.jsp?id=TetGen&lang=1>.

4.4 Research Group 4 “Nonlinear Optimization and Inverse Problems”

Head:	Prof. Dr. Dietmar Hömberg
Deputy Head:	Priv.-Doz. Dr. René Henrion
Team:	Manuel J. Arenas Jaén Dr. Ingo Bremer Moritz Ebeling-Rump Dr. Martin Eigel Robert Gruhlke Dr. Holger Heitsch Dr. Robert Lasarzik Sophie Luisa Plato (WIAS Female Master Students Program) Dr. Andreas Rathsfeld David Sommer
Secretary:	Anke Giese

The research group investigates optimization and inverse problems occurring in current engineering and economic applications. A specific focus of research in optimization and optimal control is the investigation of special structures resulting from the presence of uncertain and non-smooth data.

Last year’s work was framed by two international events. In January, we organized a “Workshop on PDE Constrained Optimization under Uncertainty and Mean Field Games” together with RG 8 *Nonsmooth Variational Problems and Operator Equations*, co-funded by DFG Transregio TRR 154 and Fondation Mathématique Jacques Hadamard. In December, the research group organized a webinar on “Math for Industry 4.0 – Models, Methods and Big Data” jointly with the Fraunhofer Institute for Industrial Mathematics and the European Consortium for Mathematics in Industry with more than 100 participants from 24 countries.

A new third-party funded project on reinforcement learning in automation engineering started in March 2020. Another one, related to the new digital twin technology applied to high-temperature applications in generative manufacturing together with Technische Universität (TU) Berlin and the Werner-von-Siemens Centre for Industry and Science began in August. Last but not least, the group is involved in two new MATH+ projects to start next year, one together with Etienne Emmerich, TU Berlin, and the other one together with RG 1 *Partial Differential Equations* and RG 7 *Thermodynamic Modeling and Analysis of Phase Transitions*.

In the following, selected scientific achievements of the research group in 2020 are detailed.

Stochastic and nonsmooth optimization

The research on stochastic and nonsmooth optimization is closely tied with the participation in three research projects associated with the programs DFG Transregio TRR 154, Berlin Mathematics Research Center MATH+, and Gaspard Monge Program for Optimization funded by Fondation

Mathématique Jacques Hadamard. Three major topics were addressed: Firstly, probabilistic bilevel problems were investigated in the context of electricity and gas markets, where in the latter context probabilistic load coverage constraints appeared in the lower level of a deterministic market model. The investigations, involving the development of an appropriate algorithmic approach, made it possible to discern the impact of these constraints on economic characteristics, e.g., social welfare and prices.

Secondly, the theoretical analysis (see [1]) and the algorithmic treatment of probabilistic constraints with respect to continuously indexed random inequalities was continued. In particular, an adaptive two-phase grid refinement algorithm was formulated for the identification of essential inequalities, which clearly outperforms ad hoc approaches based on uniform grids.

Thirdly, progress was made in risk-averse partial differential equation (PDE)-constrained optimization, where risk is modeled by means of probabilistic state constraints. For instance, in [5] the optimal Neumann boundary control of a vibrating string with uncertain initial state was investigated. Here, a minimum control in the L^2 norm was to be found such that the terminal energy of the string could be kept small with given probability (Figure 1). This work served as a preparatory step for applications to probabilistic optimization in gas transport problems as considered in TRR 154 and MATH+. Further research in progress was devoted to the structural analysis of multi-stage probabilistic programs and to the computation of lower Lipschitz moduli for possibly infinite systems of linear inequalities.

Fig. 1: Left: Optimal controls for a series of different imposed probability levels. Right: Energy of the string for 10 simulated initial states under a control guaranteeing probability 0.9 for terminal energy being smaller than some epsilon (orange strip).

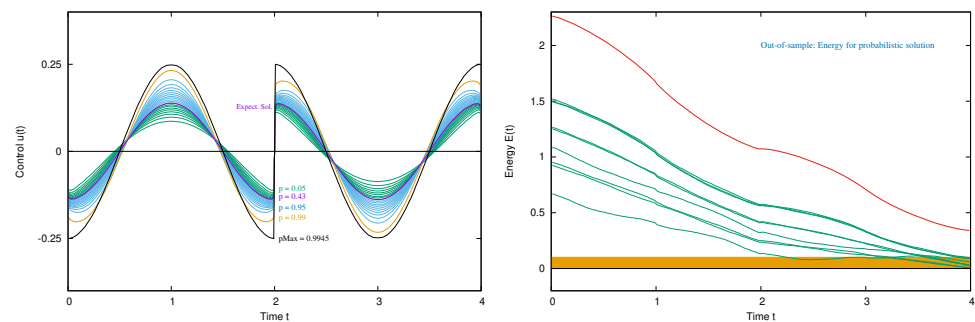

Inverse problems for stochastic data and reconstruction of stochastic surfaces

The convergence of the empirical least-squares problem in nonlinear subsets of Banach spaces was examined. For linear spaces it is known that the approximation becomes unstable when the number of samples is close to the dimension of the considered model space. In recent theoretical works, this was analyzed based on the condition of the Gram matrix of an empirical norm. It was shown that the introduction of an appropriate weight for this norm used in the optimization can lead to optimal sample complexity. This observation was reviewed in general nonlinear subsets, establishing probabilistic error bounds for the empirical best approximation error in terms of a

restricted isometry property (RIP). The developed theory presents an extension of existing theoretical results for linear spaces with the aim to generalize known results to nonlinear spaces such as sets of tensors of fixed rank. The results shown in [4] are a first step in this direction.

Porous adhesive bonds for rotor blade simulations were further examined by the construction of a parametric description of random-shaped voids in the material (Figure 2). These voids can possibly be sliced by hyperplanes and were implemented for two- and three-dimensional computations with non-trivial random micro-scale material patterns. The developed parametric domain decomposition technique with local surrogates in the setting of the Schur complement and Schwarz alternating method was extended to accommodate this problem class in preparation of a stochastic upscaling technique based on Bayesian inference. For this upscaling, observations of the micro-scale response are used to inform the coarse random model, yielding the posterior distribution of an underlying random description. The stochastic upscaling also can be seen as a possible reduction of the number of random parameters describing the fine- or coarse-scale random fluctuations, respectively.

A key weakness of standard model predictive control (MPC) is the open-loop nature of the computed local controls. Optimizing feedback controllers instead of open-loop signals is very attractive, since it provides a theoretically sound way to make the method more robust with respect to perturbations and model inaccuracies. However, this optimization in feedback control space is usually prohibitively complex. To alleviate the computational burden, a novel method based on an approximate policy iteration using fast optimization of tensor trains is being developed. A use case of the scheme under control constraints is shown in Figure 3.

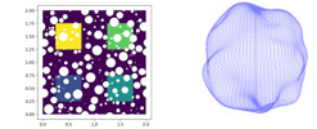
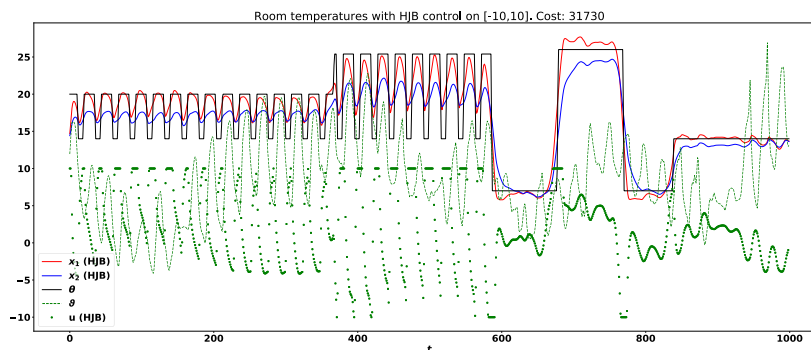

Fig. 2: Random non-periodic material inclusions (left) and parametric shape inclusion (right)

Fig. 3: Nonlinear MPC scheme for heating a building (simulation). Red and blue lines are room temperatures, black is the target temperature. Green dotted line is the outer temperature, and green dots are the computed control values.

In [6], in cooperation with Guanghui Hu (Tianjin), a natural new radiation condition is derived for the Helmholtz equation over half planes filled with special inhomogeneous materials (permittivity as a periodic function independent of the height over the surface). The classical radiation condition defined by Rayleigh expansions is generalized by wave-mode expansion based on the chains of eigenfunctions for an associated Sturm–Liouville eigenvalue problem. Using this radiation condition, the classical solution theory for gratings is generalized to gratings with inhomogeneous substrate or cover material. The strong ellipticity of the variational form enables the design and analysis of numerical methods for the boundary value problems of diffraction.

Optimal control of multifield and multiscale problems

One focus of this year's research was a generalized solution concept for nonlinear PDE systems, the so-called *dissipative solutions*. In comparison to more classical weak or measure-valued solutions, dissipative solutions do not fulfill the underlying equation in a generalized sense but rather a variation of the underlying energy dissipation principle. This formulation has several advantages, it has less degrees of freedom than measure-valued solutions and is naturally attained by structure-preserving discretizations.

For the first time, we proved the convergence of solutions to a fully discrete finite element scheme towards dissipative solutions. This was done for the case of a nonlinear PDE system modeling nematic electrolytes and constitutes the first analytic result for the considered involved nonlinear PDE system [3]. Especially the evolving anisotropy in the fluid is demanding from the numerical and analytical point of view (see Figure 4).

Fig. 4: Evolution of a molecular directional singularity and resulting velocity field. Director at time $t = 0.05, 0.15, 0.25$ (colored by the magnitude of the z -component) and the velocity field at time $t = 0.15$ (colored by the magnitude).

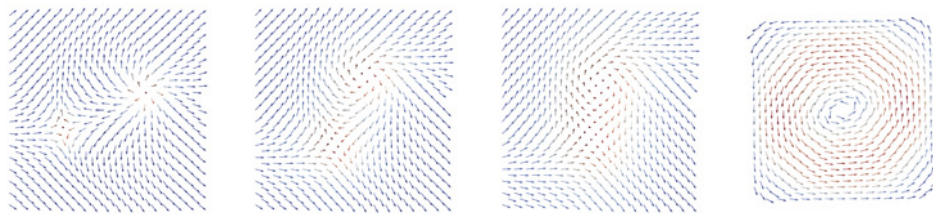

The underlying structure-preserving discretization gives rise to a dissipative solution, but no measure-valued solution can be attained. Nematic electrolytes are important for “Lab-on-a-chip” devices in life science. For such applications it is also important to be able to simulate multi-component flows in different temperature regimes. As a first step, a Cahn–Hilliard–Navier–Stokes system with energy balance was analyzed; see [7]. Therewith, the dissipative solution framework was for the first time applied to a thermodynamically consistent PDE system.

Closer to direct industrial application, the work on the modeling of a prototype set-up for inductive pre-heating in the thermal cutting of steel plates was continued in collaboration with the steel producer SSAB. As a main novelty, the model includes possible phase changes in the solid steel and the transition to the liquid state during the flame cutting process (see Figure 5 and [2]). Starting from this model, an optimization scheme for induction pre-heating of steel plates was introduced in order to achieve an optimal temperature distribution to avoid cold cracks arising after the thermal cutting.

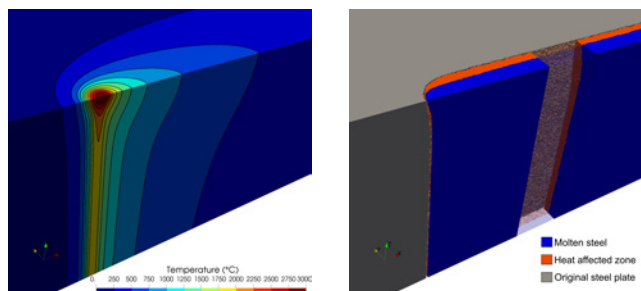

Fig. 5: Left: Temperature distribution around the heat source location. Right: Trail of molten steel (blue) and austenite (orange) after flame cutting.

References

- [1] W. VAN ACKOOIJ, R. HENRION, P. PÉREZ-AROS, *Generalized gradients for probabilistic/robust (probest) constraints*, *Optimization*, **69** (2020), pp. 1451–1479.
- [2] M.J. ARENAS JAÉN, D. HÖMBERG, R. LASARZIK, P. MIKKONEN, TH. PETZOLD, *Modelling and simulation of flame cutting for steel plates with solid phases and melting*, *J. Math. Ind.*, **10** (2020), pp. 18/1–18/16.
- [3] L. BAÑAS, R. LASARZIK, A. PROHL, *Numerical analysis for nematic electrolytes*, WIAS Preprint no. 2717, 2020, to appear in: *IMA J. Numer. Anal.*
- [4] M. EIGEL, R. SCHNEIDER, PH. TRUNSCKE, *Convergence bounds for empirical nonlinear least-squares*, WIAS Preprint no. 2714, 2020.
- [5] M.H. FARSHBAF SHAKER, M. GUGAT, H. HEITSCH, R. HENRION, *Optimal Neumann boundary control of a vibrating string with uncertain initial data and probabilistic terminal constraints*, *SIAM J. Control Optim.*, **58** (2020), pp. 2288–2311.
- [6] G. HU, A. RATHSFELD, *Radiation conditions for the Helmholtz equation in a half plane filled by inhomogeneous periodic material*, WIAS Preprint no. 2726, 2020.
- [7] R. LASARZIK, *Analysis of a thermodynamically consistent Navier–Stokes–Cahn–Hilliard model*, WIAS Preprint no. 2739, 2020.

4.5 Research Group 5 “Interacting Random Systems”

Head:	Prof. Dr. Wolfgang König
Deputy Head:	Dr. Robert Patterson
Team:	Dr. Luisa Andreis Alexander Hinsen Dr. Benedikt Jahnel Charles Kwofie Heide Langhammer Dr. Tal Orenshtein Dr. Michiel Renger Dr. Lorenzo Taggi Dr. Willem van Zuijlen
Secretary:	Christina van de Sand

In 2020, the Research Group RG 5 *Interacting Random Systems* continued its scientific work on various types of interacting stochastic systems. Most of this work concentrated on large collections of particles that interact with each other where either the interaction or the environment exhibits randomness. The applications and motivations for the research can be found in questions arising in telecommunications, chemistry, chemical engineering, and physics.

Following the decision in 2019 to establish the DFG Priority Program *Random Geometric Systems (SPP 2265)* with the head of the group as the coordinator, in 2020 applications from the group secured funding for three projects in addition to substantial resources for activities within the SPP. These projects ultimately focus on the emergence of macroscopic features in systems of spatially distributed microscopic particles, in particular, the gelation of coagulating particles and Bose–Einstein condensation and provide additional impetus to work of the research group on questions regarding the interplay between randomness, geometry, and position.

The high point of 2020 was the successful application by group member Benedikt Jahnel to the Leibniz Association for funding to enable him to establish a group at the institute specializing in random networks and applications in telecommunications. This had become a major theme in RG 5 during the last few years. An important aspect of this theme is intensive cooperation with Orange S.A. (Paris) on applied questions in telecommunications (related to new 5G technologies), which was further developed by Benedikt Jahnel and colleagues during 2020 [1]. New contracts for specific research regarding the design and protection of interacting communication devices on a random network were negotiated and signed in 2020. It is envisaged that the work on telecommunications systems and random networks will now mostly take place in the new Leibniz group.

It is a pleasure to report that Lorenzo Taggi has been offered a tenure track professorial position in Rome, and we congratulate him on his new role, which he has already taken up. He continues to work with RG 5 on ongoing projects and as part of the SPP 2265.

Reflecting the interests of the research group on large collections of particles distributed randomly in space, their connections and applications to telecommunications networks, a workshop on

“Stochastic Geometry and Communications” was organized in November. It was obviously not possible to carry out the workshop in the traditional format with all participants present at the WIAS; however, the use of video conferencing enabled interested participants from several countries to benefit from the program of lectures and discussion, which we were able to carry out in full.

The research of the group on large deviations of stochastic particle models for chemical reactions motivated the organization of a workshop on “Uncertainty and Fluctuations in Thermodynamics”. Unfortunately, this workshop was planned for March and had to be cancelled at short notice in response to what at that time was a rapidly developing public health situation.

Further topics studied by members of the group during 2020 included questions about the motions of particles in random environments, which were addressed by analyzing the behavior of the eigenvalues of the Laplace operator with random white-noise potential in large boxes in the plane (funded by the DFG Research Unit FOR 2402 *Rough Paths, Stochastic Partial Differential Equations and Related Topics*). They also included ageing for the KPZ equation [2] and in a further connection with thermodynamics, dynamic transitions between Gibbs and non-Gibbs states.

In teaching, the head of RG 5, supported by group members and a Ph.D. student, supervised many bachelor’s and master’s theses at Technische Universität Berlin on various subjects in its scientific spectrum. Four further members of the group gave lecture courses and a seminar on topics preparatory to their research.

Please find below a more detailed description of some of the achievements of the group in 2020.

Stochastic homogenization of rough walks

Rough path theory was developed in the last two decades in order to gain detailed mathematical understanding of differential equations driven by a highly irregular (random) noise. The group has been applying the theory to one of its long-standing research interests — particles performing random walks in random environments, which is a model for the motion of small particles in materials containing impurities. Recently, such random walks were considered from the rough path perspective, which provides additional detail about the randomness and proved that homogenization takes place. Homogenization means that after zooming out (rescaling) the random walk can be approximated by a diffusion process in a homogeneous environment, and with rough path techniques we gain new information about the details of this diffusion.

Figure 1 illustrates a random walk that satisfies a homogenization principle, which cannot be fully characterized by classical stochastic homogenization methods.

A generic statement in our program has the following form. Let X be a process on \mathbb{R}^d and let (X^n, \mathbb{X}^n) be its diffusively rescaled, linearly interpolated lift to the rough path space. Then, under some appropriate conditions, it converges in law in the rough path topology to a Stratonovich-enhanced Brownian motion, but with a so-called *area anomaly*, which is a deterministic matrix. The area anomaly is not detected by less detailed stochastic homogenization methods. Indeed, a stochastic differential equation driven by a noise approximated by such X^n as $n \rightarrow \infty$ would approximate the solution to the homogenized problem only after a correction of the drift term, which can be written explicitly in terms of the area anomaly. Another aspect is that the convergence in the rough path topology to an enhanced Brownian motion is determined by only the first two levels

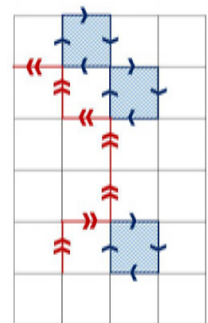

Fig. 1: A simple random walk with a deterministic loop added every two steps. The double arrows (in red) are the random walk steps, while the loops are presented by the single arrows (in blue)

of the lift. Roughly speaking, this type of result supplies all the information on the limiting path. This allows one to distinguish between the homogenized limits of two processes that would be conflated by classic stochastic methods. We have various results in this direction. The paper [3] develops a Kipnis–Varadhan theory in the rough path topology. Here, the path to be homogenized is a time integral of a function evaluated on the states of a stationary Markov process. One application is for the random conductance model, in which a walk is evolving according to a random network of conductances.

Dynamical phase transitions on finite graphs

The group continues to explore how thermodynamical principles arise as systems of interacting particles become large and, in particular, how small changes to the underlying system or its starting point can lead to radical changes in overall behavior. A particularly interesting phenomenon is the sudden development of long-lasting oscillations, otherwise known as *dynamical phase transitions*, because they represent a phase transition in the large-scale dynamics. This study aims to understand the behavior of particle systems in the many-particle limit $N \rightarrow \infty$ and long-time regime $T \rightarrow \infty$. We are particularly interested in “irreversible” models, where after a long time one expects a constant flux of particles that leaves the equilibrium invariant.

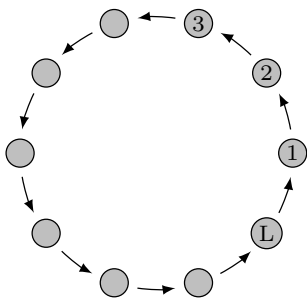

Fig. 2:
A discrete ring with
counter-clockwise jumps

As a simple example consider a discrete ring with L sites and counter-clockwise jumping particles on each site, see Figure 2. From previous work in the group [4], it follows that the *unlikeliness* that the flows of particles between the neighboring sites on the ring averaged over a long time interval from 0 to T takes a value q is quantified by minimizing a *rate function* over all possible time-dependent flows that have temporal average q . In some settings, this minimization can be restricted to situations where the particle flow rates are constant throughout the time interval without altering the minimum. If this is the case, then one expects that when the average flux q is observed, it will have been generated by a steady flow. However, in other cases the minimum is only approached by oscillating paths and so, when the average q is observed, it will have arisen due pulsating behavior in the system.

This pulsating behavior generally only occurs when q lies in a specific range; however, the change-over from steady to oscillating dynamics is discontinuous in q , revealing a dynamical phase transition (DPT). We showed that for a fixed ring size L and jump rates convex in the particle concentration, DPTs can only occur for large average fluxes q , whereas for concave jump rates, DPTs only occur for small average fluxes, while providing an example of a DPT in the permitted region [5].

Large deviations for Markov jump processes with diminishing rates

Large deviations techniques are often applied to simplify the dynamical landscape of complex, highly detailed microscopic models, while retrieving quantitative information about the random fluctuations around their typical behavior and are central to the work in the group funded by the DFG Collaborative Research Center SFB 1114 *Scaling Cascades in Physical Systems*. The group applies large deviations to Markov jump process models, for example, modeling the number of molecules of different chemicals or the number of susceptible, infected, and recovered individuals during the outbreak of a disease. Such Markov jump process models are defined by the jumps (discontinuous transitions) that take place and the rates of these jumps; the rates depend on the

state of the overall system. As the system size V (this can be the size of a container or the number of individuals in a population where an infection is spreading) becomes large, the effect of a single jump, which by definition affects only a fixed number of molecules or individuals, becomes small (of order $1/V$), while the total rate of jumps grows with the system size, because this is proportional to the number of molecules available for jumps.

As the system size V becomes large, the concentrations of the molecules approach the hydrodynamic limit. In this limit, the random fluctuations in the overall concentrations get smaller, and the dynamical evolution of the concentration tends to a deterministic one, the solution of an ordinary differential equation. This deterministic dynamics describes the evolution with high probability, while the large deviations describe events that are rare but possible, such as the sudden outbreak of a disease starting from a single carrier.

The classical proof of the relevant large deviations result uses a mathematical trick based on rescaling the rates of the jumps in the model. However, zero remains zero when multiplied by any other number, so this rescaling technique breaks down in regions where jump rates approach zero. Nevertheless, vanishing rates are an inherent feature of many applications, for example, chemical reactions stop when reactants run out, and an infection cannot spread without at least one initial case. There is thus a gap in the mathematical understanding, which can be related to small initial fluctuations when one or more jump rates differ from zero only by an amount too small to practically observe, see Figure 3.

This gap has been bridged in some special cases, without providing an understanding of where the theory might fail. Together with Andrea Agazzi (Duke University), general models with vanishing jump rates have been studied. We were able to confirm that as long as the jump rates do not decay too rapidly when approaching regions where they are zero, the large-deviations principle continues to be valid. The condition on rates not decaying too rapidly was expressed precisely in terms of a logarithmic integral of the jump rates along paths approaching the regions where they become zero. In particular, even when the process starts from an initial condition near a region of zero rates, it is able to escape with finite large deviations cost, and the large deviations principle holds.

References

- [1] A. HINSEN, B. JAHNEL, E. CALI, J.-P. WARY, *Malware propagation in urban D2D networks*, WIAS Preprint no. 2674, 2020.
- [2] J.-D. DEUSCHEL, T. ORENSHTEIN, G.R. MORENO FLORES, *Aging for the stationary Kardar–Parisi–Zhang equation and related models*, WIAS Preprint no. 2763, 2020.
- [3] J.-D. DEUSCHEL, T. ORENSHTEIN, N. PERKOWSKI, *Additive functionals as rough paths*, WIAS Preprint no. 2685, 2020, to appear in: Ann. Probab.
- [4] R.I.A. PATTERSON, D.R.M. RENGER *Large deviations of jump process fluxes*, Math. Phys. Anal. Geom., **22** (2019), pp. 21/1–21/32.
- [5] D.R.M. RENGER, D. GABRIELLI, *Dynamical phase transitions for flows on finite graphs*, J. Statist. Phys., **181** (2020), pp. 2353–2371.

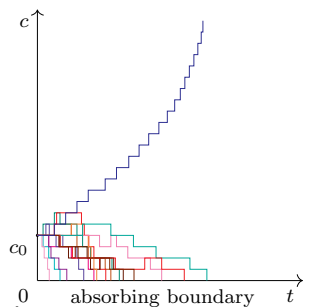

Fig. 3: A random process c_0 starting from c_0 is often absorbed at 0, but sustained growth events (blue path) cannot be ignored

4.6 Research Group 6 “Stochastic Algorithms and Nonparametric Statistics”

Head:	Prof. Dr. Vladimir Spokoiny
Deputy Head:	Priv.-Doz. Dr. John Schoenmakers
Team:	Dr. Valeriy Avanesov Priv.-Doz. Dr. Christian Bayer Franz Besold Heather Bielert (WIAS Female Master Students Program) Simon Breneis Dr. Oleg Butkovsky Darina Dvinskikh Dr. Pavel Dvurechensky Prof. Dr. Peter Friz Dr. Alexander Gasnikov Priv.-Doz. Dr. Peter Mathé Dr. Jörg Polzehl Dr. Sebastian Riedel Dr. Alexandra Suvorikova Dr. Karsten Tabelow Dr. Nikolas Esteban Tapia Muñoz
Secretary:	Christine Schneider

The Research Group 6 focuses on the research projects *Statistical data analysis* and *Stochastic modeling, optimization, and algorithms*. Applications are mainly in economics, financial engineering, medical imaging, life sciences, and mathematical physics. Special interest is in the modeling of complex systems using methods from nonparametric statistics, statistical learning, risk assessment, and valuation in financial markets using efficient stochastic algorithms and various tools from classical, stochastic, and rough path analysis. RG 6 has a leading position in the above-mentioned fields with important mathematical contributions and the development of statistical software.

Members of the research group participated in the DFG Collaborative Research Center SFB 1294 *Data Assimilation*, the *Berlin Center for Machine Learning*, the DFG International Research Training Group IRTG 1792 *High Dimensional Non Stationary Time Series*, the DFG International Research Training Group IRTG 2544 *Stochastic Analysis in Interaction*, the DFG Research Unit FOR 2402 *Rough Paths, Stochastic Partial Differential Equations and Related Topics*, and the Cluster of Excellence *Berlin Mathematics Research Center MATH+*.

Statistical data analysis

The focus within the project area *Statistical data analysis* is on methods that automatically adapt to unknown structures using some weak qualitative assumptions. *Statistical inference* helps to address an important question of reliability of the statistical decision, and it is nowadays an unavoid-

able element of any statistical analysis. The research includes, e. g., frequentist and Bayesian methods for dimension reduction and manifold learning, change-point detection, regularization and estimation in inverse problems, model selection, feature identification, inference for random networks and complex statistical objects using optimal transport and Wasserstein barycenter. Research within this subarea covered both theoretical and applied statistical problems.

Highlights 2020:

- The article “Statistical inference for Bures–Wasserstein barycenters” by Alexey Kroshnin, Vladimir Spokoiny, Alexandra Suvorikova was accepted to be published in *The Annals of Applied Probability* (WIAS Preprint no. 2788, 2020).
- Kirill Efimov successfully defended his dissertation “Adaptive nonparametric clustering” at the Humboldt-Universität zu Berlin (under the supervision of Vladimir Spokoiny).
- The new MATH+ project EF3-8 “Analysis of brain signals by Bayesian optimal transport” (Principal Investigators (PIs): Pavel Dvurechensky, Klaus-Robert Müller, Shinchi Nakajima (both Technische Universität Berlin), and Vladimir Spokoiny) was approved for funding.
- The new MATH+ project EF3-9 “Mathematical framework for MR poroelastography” (PIs: Alfonso Caiazzo (RG 3) *Numerical Mathematics and Scientific Computing*, Karsten Tabelow, In-golf Sack (Charité Berlin)) was approved for funding.
- The paper “Data-driven confidence bands for distributed nonparametric regression” by Valeriy Avanesov was presented at the 33rd Annual Conference on Learning Theory (COLT 2020).
- The article “An accelerated directional derivative method for smooth stochastic convex optimization” by Pavel Dvurechensky, Eduard Gorbunov, and Alexander Gasnikov appeared online in the *European Journal of Operational Research*.

In 2020, the members of the group made some significant contributions to statistical literature.

The paper by Spokoiny and Panov (arxiv:1910.06028, 2020) provides a unified approach to study the properties distribution for rather general class models including generalized linear models, logistic/binary regression, nonparametric density estimation, among many others. The main results claim a nearly Gaussian behavior of the posterior with explicit finite sample error bounds, and address the use of Bayesian credible sets as frequentist confidence sets. An extension of the approach to nonlinear inverse problems using the so-called *calming device* is described in Spokoiny, arxiv:1912.12694, 2020. The basic idea is to extend the parameter space by introducing an auxiliary parameter and transferring the nonlinear model structure to the prior distribution. This method allows to get sharp results on Bayesian inference avoiding the cram of empirical processes.

We investigated the issues concerning statistical inference in Bures–Wasserstein space. We obtained the results concerning the convergence and concentration properties of the Bures–Wasserstein barycenters [1]. Theoretical results obtained are used for statistical analysis of three-dimensional chromatin folding in single-cell data.

In 2020, we continued studying computational aspects of optimal transport problems and Wasserstein barycenter problems. Within the project “Optimal transport for imaging” (jointly with RG 8 *Nonsmooth Variational Problems and Operator Equations*) funded by the Cluster of Excellence *Berlin Mathematics Research Center MATH+*, we developed a new quantization technique for distributed optimization, which resulted in a more efficient algorithm for approximating a Wasserstein

barycenter of a set of probability measures. In the same project, we investigated a function-space-based framework for image segmentation via optimal transport distances used as data-fitting term in an inverse problem. We also proposed an accelerated alternating minimization algorithm for a multimarginal optimal transport problem that generalizes the standard optimal transport problem and contains the Wasserstein barycenter problem as a special case. New complexity bounds were obtained, and the superiority of our method in practice was demonstrated.

Motivated by statistical inverse problems that lead to optimization problems with singular loss function, such as covariance matrix estimation, we proposed a new analysis for the classical Frank–Wolfe algorithm in a non-classical setting of self-concordant function minimization. Classical sub-linear rate was obtained and a generalization for minimization on polytopes with linear convergence rate was proposed. The result was published at the 37th International Conference on Machine Learning (ICML 2020, online).

Modeling and analysis of quantitative magnetic resonance (MR) imaging data constitutes an important contribution to the WIAS main application area Quantitative Biomedicine. This also includes biophysical models for neuroscientific research questions and statistical data analysis methods. In 2020, we contributed to a chapter of a Springer monograph dedicated to imaging of the kidney with high clinical relevance. Furthermore, together with RG 3, we successfully applied for a MATH+ project "Mathematical framework for MR poroelasticity". In 2021, the project will lay mathematical foundations for a new multimodel MR technique that enables in-vivo pressure estimation in brain tissue.

The MATH+ project EF3-1 "Model-based geometry reconstruction from TEM images" (together with RG 1 *Partial Differential Equations*) aims to infer on geometric parameters of quantum-dot nanostructures from low resolution images from transmission electron microscopy (TEM). We established a virtual microscope for the simulation of such images to be able to experimentally characterize the image space. While the theoretical justification of the computational model achieved within the project is reported by RG 1, we focus here on the usage of the database of TEM images for inference methods. In the context of a bachelor thesis, we recently started to use this data base for solving the quantum-dot-type classification problem using deep neural network techniques.

Although highly rated, the proposal for funding the Mathematical Research Data Initiative (MaRDI) (<http://www.mardi4nfdi.org/>) coordinated by WIAS as a leading institution within the National Research Data Initiative (NFDI) was not selected for funding in the first call. However, in 2020, RG 6 together with RG 1 coordinated the further development of the consortium goals and approaches, which resulted in a proposal for the second call of NFDI.

Stochastic modeling, optimization, and algorithms

This project area focuses on the solution of challenging mathematical problems in the field of optimization, stochastic optimal control, and stochastic and rough differential equations. These problems are particularly motivated by applications in the finance and energy industries. One central theme is the rigorous mathematical analysis of innovative methods and algorithms based on fundamental stochastic principles. These methods provide effective solutions to optimal control

and decision problems for real-world high-dimensional problems appearing in the energy markets, for instance. Another focus of the project area is on modeling in financial and energy markets, for instance, volatility modeling, calibration, and the modeling of complex-structured products in energy and volatility markets.

Highlights 2020:

- The IRTG 2544 *Stochastic Analysis in Interaction* started. Peter Friz and Christian Bayer are among the PIs of the IRTG. Simon Breneis started as a Ph.D. student within the IRTG in RG 6.
- A draft proposal for a DFG Collaborative Research Center *Rough Analysis and Stochastic Dynamics* (Friz–Perkowski) was submitted in December 2020.
- The second edition of “A Course on Rough Paths” by Peter Friz and Martin Hairer appeared; see [5].
- “Pricing American options by exercise rate optimization” by Christian Bayer, Raul Tempone, and Sören Wolfers appeared as a *featured article* in *Quantitative Finance*.
- The article “Generalized couplings and ergodic rates for SPDEs and other Markov models” by Oleg Butkovsky, Alexei Kulik, and Michael Scheutzw was published in the *Annals of Applied Probability*.
- The article “Strong existence and uniqueness for stable stochastic differential equations with distributional drift” by Siva Athreya, Oleg Butkovsky, and Leonid Mytnik was published by the *Annals of Probability*, see [2].
- The article “Precise asymptotics: Robust stochastic volatility models” by Peter Friz, Paul Gassiat, and former WIAS postdoc Paolo Pigato is forthcoming in *Annals of Applied Probability*, see [6].

In the area of regression-based methods for optimal stopping and control in energy markets, the new approach towards numerically solving optimal stopping problems via reinforced regression was published. The main idea of this method, a backward regression where in each backward induction step the regression basis is enhanced with new basis functions “learned” from the preceding step, is extended and generalized to optimal control in WIAS Preprint no. 2792. As such, the method of reinforced optimal control has a flavor of deep learning.

The randomization approach for American options (i.e., continuous time optimal stopping) by Bayer et al. (see the Scientific Highlights article on page 42) was newly designed for discrete exercise (Bermudan options) and completed with a rigorous convergence analysis in WIAS Preprint no. 2697. As such, this paper provides a theoretical justification for several deep learning-based approaches for optimal stopping in the recent literature.

For optimal stopping problems a stochastic mesh-type algorithm was developed and published in [4]. It was proved that, remarkably, in worst cases this method outperforms the popular regression based Longstaff–Schwartz and Tsitsiklis–van Roy algorithms. In particular, for continuous-time optimal stopping (i.e., American options) it turned out that the mesh algorithm has a finite tractability index, while the tractability of the regression methods tends to explode.

The research on nonlinear Markov or McKean–Vlasov processes, which are stochastic processes related to nonlinear Fokker–Planck equations whose dynamics at a certain time depend on the present distribution of the process at that time, was continued. Such processes arise in various

applications, for example, lithium battery modeling, population dynamics, neuroscience, and financial mathematics. In particular, the regression-based estimators for solving McKean–Vlasov-related final value problems globally in space with application to the optimal stopping problem was continued and published as [3]. This estimator involves the realization of an interacting particle system connected with the McKean–Vlasov equation. The main challenge in this study was the fact that the particles are correlated due to their interaction, unlike the case of standard Monte Carlo regression. A full convergence analysis was provided.

In several applications of optimal stopping and control, the expected reward is not the most appropriate target that is to be optimized. Depending on the problem under consideration, it may be more suitable to replace the expected reward by some more general (so-called *robust*) utility functional. In this context, a path-wise duality approach was developed for the “robust” multiple stopping problem in WIAS Preprint no. 2728.

Focus Platform *Quantitative Analysis of Rough and Stochastic Systems*

The investigation of rough volatility models continued. A new model based on the newly introduced “log-modulated fractional Brownian motion” was developed. Such processes are well-defined continuous Gaussian processes even when the Hurst index $H = 0$. Therefore, properties of the model such as the at-the-money-implied volatility skew can be well studied even for extremely rough volatility, i.e., when H is close to 0; see WIAS Preprint no. 2752.

In addition, a new analysis of rough stochastic volatility models as rough backward stochastic partial differential equations was performed; see WIAS Preprint no. 2745. Hence, partial differential equation (PDE) techniques, albeit in infinite dimensions, become available to the analysis and numerics of European and American option pricing in rough stochastic volatility models. Such methods were also proposed in the above work, and successful numerical experiments were reported.

A framework of discrete-time rough path *signatures* was developed, which can be used to analyze time-warping invariance of discrete time series. In particular, the algebraic properties of the set of such discrete time signatures were studied in detail, leading to a concise algebraic description of different feature extraction maps for time series. Further work deals with the extraction of features that are invariant under the linear action of the orthogonal group on input data. These results are documented in WIAS Preprints no. 2736, 2760, 2795, and 2796. In further developments, stability of residual neural networks was studied with the help of this framework; see WIAS Preprint no. 2732.

A method for solving optimal stopping problems for rough non-Markov processes in terms of *randomized* stopping times defined in terms of the rough path *signatures* was developed in WIAS Preprint no. 2790. This paper represents the first rigorous convergence results for the signature method for stochastic optimal control of non-Markov processes.

In 2020, we studied the unique ergodicity of infinite-dimensional Markov processes (in particular, stochastic partial differential equations (SPDEs)) and developed two complementary approaches. We showed that if a Markov process is order preserving, then that under very mild (and nearly optimal) additional assumptions it is exponentially ergodic. This result allows to establish the

exponential ergodicity of a stochastic reaction-diffusion equation in the hypoelliptic setting, thus refining and complementing the corresponding results in a seminal paper of Hairer and Mattingly (2011). Furthermore, we showed that, under the same conditions, synchronization-by-noise takes place.

For general Markov processes, we developed a set of verifiable user-friendly conditions for exponential ergodicity based on generalized coupling technique. This approach allowed to obtain exponential ergodicity of various SPDEs in the effectively elliptic setting (including two-dimensional stochastic Navier–Stokes equations on an arbitrary bounded domain).

References

- [1] A. KROSHNIN, V. SPOKOINY, A. SUVORIKOVA, *Statistical inference in Bures–Wasserstein barycenters*, WIAS Preprint no. 2788, 2020, to appear in: Ann. Appl. Probab.
- [2] S. ATHREYA, O. BUTKOVSKY, L. MYTNIK, *Strong existence and uniqueness for stable stochastic differential equations with distributional drift*, Ann. Probab., **48** (2020), pp. 178–210.
- [3] D. BELOMESTNY, J.G.M. SCHOENMAKERS, *Optimal stopping of McKean–Vlasov diffusions via regression on particle systems*, SIAM J. Control Optim., **58** (2020), pp. 529–550.
- [4] D. BELOMESTNY, M. KALEDIN, J.G.M. SCHOENMAKERS, *Semi-tractability of optimal stopping problems via a weighted stochastic mesh algorithm*, Math. Finance, **30**:4 (2020), pp. 1591–1616.
- [5] P. FRIZ, M. HAIRER, *A Course on Rough Paths: With an Introduction to Regularity Structures*, Universitext, Springer International Publishing, Basel, 2020.
- [6] P. FRIZ, P. GASSIAT, P. PIGATO, *Precise asymptotics: Robust stochastic volatility models*, arXiv preprint no. 1811.00267, to appear in: Ann. Appl. Probab.

4.7 Research Group 7 “Thermodynamic Modeling and Analysis of Phase Transitions”

Head (acting):	Prof. Dr. Barbara Wagner
Deputy Head (acting):	Priv.-Doz. Dr. Olaf Klein
Team:	Prof. Dr. Christiane Kraus Dr. Manuel Landstorfer Dr. Rüdiger Müller Leonie Schmeller
Secretary:	Ina Hohn

Research Group 7 conducts research on multiscale modeling, analysis, and numerical simulation of complex materials. The main expertise are the thermodynamically consistent modeling, systematic asymptotic methods, in particular, for singularly perturbed problems, rigorous analysis of the derived models, and analysis of hysteresis properties. Application areas focus on fundamental processes that drive micro- and nano-structuring of multi-phase materials and their interfaces, electrochemical processes as well as electro-magneto-mechanical components. For these application areas the research group develops material models for liquid polymers, hydrogels, active gels, and polyelectrolyte gels, as well as material models of electrochemistry such as for lithium-ion batteries and electro-catalytic applications, and models for magnetorestrictive materials. For the corresponding, typically, free boundary problems of systems of coupled partial differential equations the research group develops mathematical theory and numerical algorithms.

Multiphase flow problems in soft and living materials

Energy-based mathematical methods for reactive multiphase flows. The collaboration within the Cluster of Excellence *Berlin Mathematics Research Center* MATH+ joint project “Modeling and analysis of suspension flows”, headed by Volker Mehrmann (Technische Universität Berlin), Dirk Peschka (WG 1 *Modeling, Analysis and Scaling Limits for Bulk-Interface Processes*), Matthias Rosenau (GeoForschungsZentrum Potsdam), Marita Thomas (WG 1), and Barbara Wagner (RG 7), was extended under the new title “Variational methods for viscoelastic flows and gelation” headed by Dirk Peschka, Matthias Rosenau, Marita Thomas, and Barbara Wagner. Now, the focus is on processes of sol-gel transitions in concentrated polymer suspensions and their biomedical applications. This collaboration also led to the successful application of the principal investigators (PIs) for the Thematic Einstein Semester (TES) on “Energy-based mathematical methods for reactive multiphase flows” together with Alexander Mielke (RG 1 *Partial Differential Equations*). The TES was co-organized together with Matthias Liero (RG 1) and started in October 2020 with a completely online kick-off conference, student compact courses, as well as an ongoing seminar on related topics.

Dewetting dynamics and morphology of liquid polymers on hydrogels. Dewetting is the hydrodynamic process where a uniform layer of liquid destabilizes and decays into distinct patterns of stationary droplets by virtue of interfacial and intermolecular energies. In collaboration with

a group of experimental physicists at the Universität des Saarlandes, Leonie Schmeller (RG 7), Barbara Wagner (RG 7), and Dirk Peschka (WG 1) developed a mathematical model and numerical algorithms to unravel the spinodal dewetting process of a liquid polymer film from another liquid polymer substrate, where a new transient wave structure was discovered; see Figure 1 and Figure 2. In the tandem project “Dynamic wetting and dewetting of viscous liquid droplets/films on viscoelastic substrates” (PIs: Barbara Wagner (RG 7), Ralf Seemann (Saarbrücken)) within the DFG Priority Programme SPP 2171 *Dynamic Wetting of Flexible, Adaptive and Switchable Surfaces*, we also developed a new weak formulation for a hydrogel substrate, based on the model [3], and a corresponding new numerical algorithm. This will be used to answer fundamental open questions regarding morphology and dynamics of a liquid layer on soft gels.

Multiphase problems in quantitative biomedicine. The Oxford–Berlin network for Quantitative Regenerative Medicine initiated by Sarah Waters, Andreas Münch (both University of Oxford), Georg Duda (Charité), and Barbara Wagner (RG 7) and another seed grant “Quantitative Modelling of Interstitial Fluid Pressure in Fibre Reinforced Hydrated Networks”, funded by the UK Regenerative Medicine Platform with partners from Imperial College London, University of Nottingham, University of Oxford, and WIAS led to intensive interdisciplinary research focused, in particular, on controlled tissue regeneration. While our research results are being written up, the initiatives also led to a new interdisciplinary proposal on “Mathematical modelling of cellular self-organization on stimuli responsive extracellular matrix (ECM)” headed by Sara Checa and Ansgar Petersen (both at Charité) and Barbara Wagner (RG 7), being funded for 12 months by MATH+ (AA1-12). Here, we develop an extension of our theory on hydrogels into a double-network hydrogel model with a physically breakable network as a toy model for the ECM to simulate the remodeling of the ECM as a result of cellular traction forces, coupled to an extension of an existing agent-based model (in the group of Sara Checa) of mechanically driven cellular organization. The theoretical investigations are accompanied by experimental results in the group of Ansgar Petersen.

Eventually, biologically more realistic models will include features of polyelectrolyte gels, where dependence on concentrations of surrounding salt solution and electrostatic interactions will be taken account of. The fundamental models, their dynamics and asymptotic theory were developed in a series of articles; see Celora–Hennessy–Münch–Wagner–Waters (2020), [1, 2].

Mathematical models and theory of electrochemical processes

MATH+ AA2-6: “Modeling and Simulation of multi-material electrocatalysis” (MultECat). Multi-material electrodes play an important role in modern electrocatalysis applications. The project headed by Manuel Landstorfer (RG 7) and Jürgen Fuhrmann (RG 3 *Numerical Mathematics and Scientific Computing*) aims at continuum models for electrocatalysis at the $nm - \mu m$ scale, coupling reactions on catalytic interfaces, reactant transport in electrolytes, and charge transport in catalyst substrates.

Most standard solid metal electrodes are polycrystalline, exhibiting many facets of differently oriented grains to the electrolyte. Therefore, the surface is non-homogeneous in its physical properties. The electrochemical characterization of the equilibrium properties of polycrystalline electrodes [5] underlined the importance of boundary layers for electrocatalytic applications. Thereby,

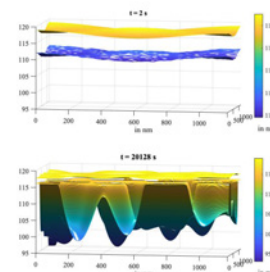

Fig. 1: A two-layer system in the initial state where the interface and surface are in phase (top) and after a time when they show an anti-phase behavior (bottom)

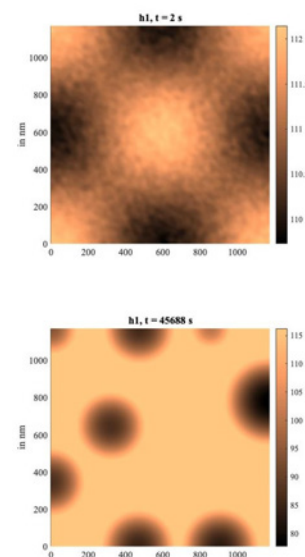

Fig. 2: Initial data with a large wavelength and white noise (top). Holes formed at the (predicted) spinodal wavelength (bottom)

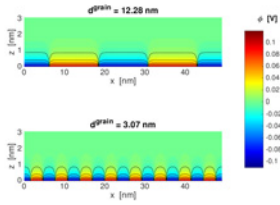

Fig. 3: Boundary layer of the electrostatic potential for a bi-crystalline interface with different grain sizes

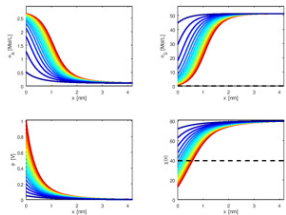

Fig. 4: Profiles of the ion density n_A , solvent density n_S , electric potential φ , and susceptibility χ for various applied voltages

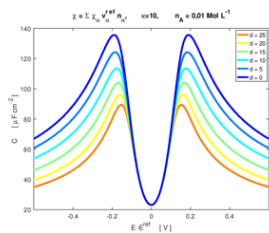

Fig. 5: Reduction of the differential capacitance related to the dielectric decrement d

it straightly points to another problem of standard electrolyte models that are all built on the very basic Poisson equation

$$-\operatorname{div}((1 + \chi)\varepsilon_0 \nabla \varphi) = q, \quad (1)$$

where φ is the electric potential, q is the free charge of the electrolyte, ε_0 is the vacuum permittivity, and χ the dielectric susceptibility. Experiments show that the susceptibility χ of aqueous electrolytes depends on the local composition in a form $\chi(c) = \chi_0 - d \cdot c$, as well as it depends on the electric field strength, i.e. on $|\nabla \varphi|$. Although in electrolytic boundary layers, the concentration changes from dilute to highly concentrated solutions and the field strength can rise from almost zero in the bulk to 10^9 Vm^{-1} , standard models treat χ as a constant!

Careful thermodynamic analysis reveals that it is not sufficient to just generalize the constant χ on the left-hand side of (1) to a function $\chi(c, |\nabla \varphi|)$. Instead, also the momentum balance needs to be generalized by additional terms and these couple back to the left-hand side of (1). In particular, a careful analysis of the pressure is necessary.

In this project, a rigorous thermodynamically consistent model for non-constant susceptibility is developed. In the case of field-dependent $\chi(|\nabla \varphi|)$, we found that some approaches that are used in the literature violate the ellipticity condition for (1) and proposed alternative constitutive models. We analyze the impact on the double layer structure, see Figure 4, and show that this effect can explain a reduction of the differential capacitance. In the case of concentration-dependent $\chi(c)$, we proposed and analyzed a simple approach of a constitutive model and demonstrated that the dielectric decrement explains a reduction of the differential capacitance; see Figure 5.

BMBF Project MALLi². Manuel Landstorfer of RG 7 is the project coordinator of the BMBF compound project MALLi²¹. The project aims to improve the lifetime estimation of lithium-ion batteries (LIBs) with mathematical modeling techniques. Within MALLi², the ageing processes are systematically investigated via their electrochemical characteristics, i.e., current-voltage relations, recorded over the (1–2)-year charge-discharge cycles. Further, the microstructural degradations are investigated with X-ray-computed tomography yielding three-dimensional datasets of the porous electrode structure evolution. These datasets serve to validate the mathematical models developed within MALLi².

The mathematical modeling is based on non-equilibrium thermodynamics, the WIAS framework for electrochemical interfaces and homogenization techniques. This approach yields a partial differential equation system that accounts for diffusion and conductivity in the electrolyte phase, lithium-ion concentration in the active particles, and intercalation reactions at the electrode-electrolyte interface; see [6].

Understanding and optimizing the effective properties of the porous microstructure of the battery electrodes, such as permeability, tortuosity, or effective conductivity, is an important aspect of battery research. The materials morphology has a significant impact on the effective properties, which arise from the homogenization procedure. The numerical determination of these effective properties requires a proper description of the three-dimensional microstructure. Because tomographic imaging is expensive in time and costs, stochastic microstructure modeling is a valuable tool for

¹ Modellbasierte Abschätzung der Lebensdauer von gealterten Li-Batterien für die 2nd-Life Anwendung als stationärer Stromspeicher

virtual materials testing, where a large number of realistic three-dimensional microstructures can be generated and used as geometry input for spatially-resolved numerical simulations.

Within the project, a complete procedure for this purpose was developed. Our cooperation partners of Universität Ulm developed a stochastic process that yields realistic, periodic three-dimensional microstructures parameterized in terms of spherical harmonics. Based on this result, a surface meshing procedure was developed that exploits the spherical harmonics representation of each particle, yielding a waterproof surface mesh of the corresponding microstructure. This surface mesh serves as an input for the WIAS Software TetGen to generate high-quality volume meshes; see Figure 6. With these volume meshes, the effective parameters are computed via numerical simulations of the corresponding cell problem arising from the homogenization; see [7].

Due to its efficient implementation, the present method can be used to investigate a whole sequence of microstructures, modeling the degradation during discharge. Therewith, we are able to estimate the degradation of the corresponding effective parameters and to compare them with experimental data.

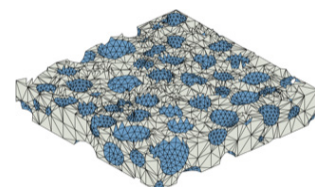

Fig. 6: Cut through the volume mesh of a three-dimensional microstructure generated with the methodology of [7]

Hysteresis, electromagnetic-mechanical components, and uncertainty quantification

The investigations on uncertainty quantification for models involving hysteresis operators were continued. In the past, experimental data for Terfenol-D, provided by Daniele Davino (Benevento, Italy), had been used to compute appropriate values for the parameters in a model following Sec. 5.1 of Davino–Krejčí–Visone (2013), and some information on the uncertainty of these parameters were determined, see [4]. Now, further computations to identify these uncertainties were performed by using the software package UQLab (Marelli–Sudret (2014), <https://www.uqlab.com/>).

References

- [1] M.G. HENNESSY, G.L. CELORA, A. MÜNCH, B. WAGNER, S.L. WATERS, *Asymptotic study of the electric double layer at the interface of a polyelectrolyte gel and solvent bath*, WIAS Preprint no. 2751, 2020.
- [2] G.L. CELORA, M.G. HENNESSY, A. MÜNCH, B. WAGNER, S.L. WATERS, *A kinetic model of a polyelectrolyte gel undergoing phase separation*, WIAS Preprint no. 2802, 2020.
- [3] M.G. HENNESSY, A. MÜNCH, B. WAGNER, *Phase separation in swelling and deswelling hydrogels with a free boundary*, *Phys. Rev. E*, **101** (2020), pp. 032501/1–032501/14.
- [4] O. KLEIN, D. DAVINO, C. VISONE, *On forward and inverse uncertainty quantification for models involving hysteresis operators*, *Math. Model. Nat. Phenom.*, **15** (2020), pp. 53/1–53/19.
- [5] R. MÜLLER, J. FUHRMANN, M. LANDSTORFER, *Modeling polycrystalline electrode-electrolyte interfaces: The differential capacitance*, *J. Electrochem. Soc.*, **167**:10 (2020), pp. 106512/1–106512/15.
- [6] M. LANDSTORFER, *A discussion of the cell voltage during discharge of an intercalation electrode for various C-rates based on non-equilibrium thermodynamics and numerical simulations*, *J. Electrochem. Soc.*, **167** (2020), pp. 013518/1–013518/19.
- [7] M. LANDSTORFER, B. PRIFLING, V. SCHMIDT, *Mesh generation for periodic 3D microstructure models and computation of effective properties*, *J. Comput. Phys.*, **431** (2021), pp. 110071/1–110071/20.

4.8 Research Group 8 “Nonsmooth Variational Problems and Operator Equations”

Head:	Prof. Dr. Michael Hintermüller
Team:	Dr. Amal Alphonse Jo Andrea Brüggemann Dr. Guozhi Dong Sarah Essadi Dr. Caroline Geiersbach Tobias Keil Dr. Axel Kröner Hong Nguyen Dr. Kostas Papafitsoros Clemens Sirotenko Steven-Marian Stengl Kathrin Völkner (WIAS Female Master Students Program)
Guests:	Jonas Holley Dr. Olivier Huber
Secretary:	Selin Uyanik
Nonresident Members:	Prof. Dr. Martin Brokate

The research expertise of the group lies in the area of optimization associated to nonsmooth energies in infinite-dimensional spaces as well as to partial differential equations (PDEs) with nonsmooth structure. The group focuses on the theoretical analysis and modeling of corresponding real-world problems as well as the development of efficient solution algorithms and their computational realization. Particular fields of interest involve generalized Nash equilibrium problems and stochastic aspects of those, modeling of gas networks, quasi-variational inequalities (QVIs), physics and model-based image processing, as well as optimization problems of fluid flows. RG 8 actively contributes to the main application areas of WIAS *Quantitative Biomedicine*, *Optimization and Control in Technology and Economy*, *Flow and Transport*, as well as aspects of *Materials Modeling*.

Four new members started in the reported period: Hong Nguyen is a new Ph.D. student working in the project “Optimal shape design of air ducts in combustion engines” which is part of the Marie Curie Actions Innovative Training Network ROMSOC. Caroline Geiersbach joined the group as a postdoc from the University of Vienna, with expertise on stochastic optimization. Sarah Essadi and Clemens Sirotenko joined the group as Ph.D. students during the last quarter of 2020.

General relevance of the scientific topics considered by the RG

The study of problems that are associated with a nonsmooth structure is the main research focus of RG 8. This research field is motivated by the plethora of ways in which nonsmoothness arises in real-world applications. Examples include nondifferentiable constraints, game theory

(Nash equilibria), nonsmooth objective functionals in optimization models, as well as the nowadays widespread use of nonsmooth artificial neural networks.

Nonsmoothness is challenging since regularity is a classical assumption for existing results to hold. To tackle such problems, there are two main approaches: The first one is to regularize the nonsmoothness in order to use existing results and perform some limiting analysis. The second approach is to develop theories that can directly handle specific types of nonsmoothness. For instance, certain nonsmooth optimization problems commonly used in image processing that have a crucial role in preserving discontinuities (image edges) can be tackled via convex duality theory. On the other hand, in the context of noncooperative games, the characterization of Nash equilibrium can be done by considering the collection of first-order conditions for all game participants. This approach leads to a (quasi-)variational inequality, for which existence results and numerical schemes are available. In the context of stochastic optimization, stochastic approximation has proven to be an effective tool for solving problems with nonsmoothness. This class of algorithms includes random iterative schemes, such as the proximal stochastic gradient method, and has been applied to optimization problems in infinite dimensions.

Selected research results

Optimal control of quasi-variational inequalities. The group made recent contributions to the sensitivity analysis and optimal control of quasi-variational inequality (QVI) problems, advancing from earlier successful investigations on the directional differentiability of the source-to-solution map of elliptic and parabolic QVIs, respectively, and thereby further developing the state of the art in the area. QVIs are appropriate descriptors of many models in the physical and biological sciences and have received renewed attention in recent years, making their study topical and important, as well as providing a complicated mathematical structure worth investigating in its own right.

The contributions of [2] in the context of elliptic QVIs include (a) existence theory of QVIs through a sequential regularization through PDEs, (b) directional differentiability results (extending previous work) for unsigned sources and directions, and (c) the derivation of various forms of stationarity conditions (namely, Bouligand-, ϵ -almost C - and strong stationarity) for optimal control problems with QVI constraints, providing a rather comprehensive study of the topic. Recalling that, in general, solutions of QVIs are not unique and working under the circumstances that enable one to order solutions, hence, having the existence of a minimal and maximal solution in hand, in [3], various properties of the maps m and M that take a source term and output, respectively, the minimal and the maximal solution of that source term. In particular, it is shown that both maps are directionally differentiable with respect to forcing terms and directions that have a certain sign and the directional derivatives (which themselves satisfy a QVI) are the monotone limits of sequences. This work paves the way to providing a stationarity system for optimal control of the minimal or maximal solution maps, a problem that still possesses challenges.

Generalized Nash equilibrium problems (GNEPs). As a crucial step towards tackling more involved GNEP problems under uncertainty, the research in [5] provided necessary and sufficient first-order optimality conditions for convex stochastic optimization problems subject to almost

sure state constraints. The framework generalizes classical results from finite-dimensional two-stage stochastic programming to the infinite-dimensional setting; the theory handles both equality and conical constraints as well as abstract convex constraints on the (deterministic) control and (random) state. Currently, research is focused on building on this work to enable a Moreau–Yosida regularization of the state constraints, coupled with a stochastic approximation scheme to solve the problem efficiently.

In practice, these techniques need to be combined with powerful discretization methods. For this sake finite element methods (FEM) are usually employed in the context of partial differential equations. On the one hand, the regularity of the state might suffer from the domain, which might result in lowered convergence rates. On the other hand, the presence of an obstacle-type state constraint might lead to coincidence sets resulting in areas where degrees of freedom do not need to be invested. To address both phenomena, adaptive mesh refinement can be used. Therefore, we developed primal-dual gap estimators for a larger class of equilibrium problems covering not only GNEPs but also QVIs.

Fig. 1: Application of primal-dual gap estimators to the thermoforming QVI in [1]. Left: Mesh. Right: Final mould together with the membrane.

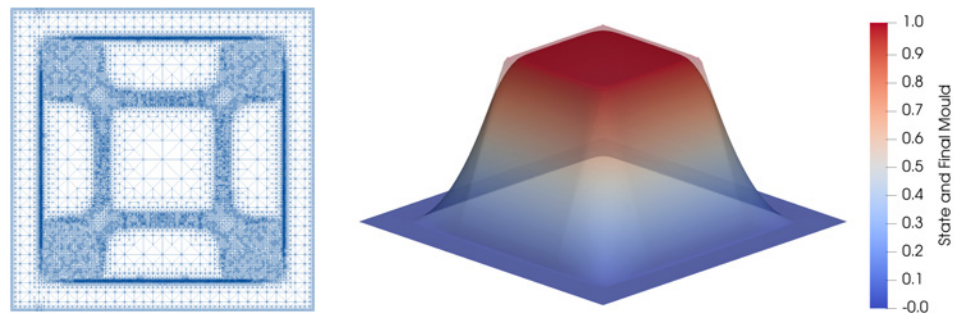

These techniques have been successfully applied to deterministic problems so far, e.g., to an application in thermoforming, see Figure 1, that was investigated in previous works by the research group in [1]. One of the next steps is the investigation of numerical schemes compatible to the stochastic situation discussed above. This, however, is ongoing research.

MATH+

Optimization with learning-informed differential equations. The group continued its activities in image processing during 2020 with special focus on *learning-informed* physics/model-based imaging. This research is carried out within the project “Direct reconstruction of biophysical parameters using dictionary learning and robust regularization” in the frame of the Center of Excellence MATH+. In [4], a general optimization framework subjected to physical processes (typically differential equations) whose constituents are only accessible through data and, therefore, suitable to be learned by artificial neural networks, was introduced and analyzed. The main idea is that by providing some experimental data, neural networks are employed either to learn some unknown nonlinearity in the physical models or to represent the complex parameter-to-solution maps of the differential equations. This general framework reads as follows:

$$\text{minimize} \quad \frac{1}{2} \|Ay - g\|_H^2 + \frac{\alpha}{2} \|u\|_U^2, \quad (1)$$

$$\text{subject to} \quad y = \Pi_{\mathcal{N}}(u), \quad u \in \mathcal{C}_{ad}. \quad (2)$$

Here, the operator $\Pi_{\mathcal{N}}$ in (2) is a neural network induced operator, modeling some ground-truth physical process Π , and it is interpreted as a *learning-informed control-to-state map* $u \mapsto y$ for the optimal control framework (1)–(2). The control u denotes some biophysical parameters that one wishes to quantify. On the other hand, (1) refers to a general image reconstruction problem where the image data g is assumed to have resulted from the action of a linear operator A on the state y . In [4], well-posedness of the framework was shown and conditions under which the solutions of (1)–(2) behave in a stable way with respect to the neural network approximation $\Pi_{\mathcal{N}}$ of Π were proven.

The versatility of the general framework (1)–(2) was highlighted in two key applications. The first one was in quantitative magnetic resonance imaging (MRI), an area in which the group has been active during the last years. There, a neural network is used to approximate the solution map of the *Bloch equations*, a system of ordinary differential equations that characterize the underlying dynamics by connecting the biophysical parameters of interest ($u = (T_1, T_2)$), i.e., the magnetic relaxation times, to the measured MRI signal. This learning-informed solution map is then embedded into the MRI reconstruction problem (corresponding to (1) in the general framework). Numerical experiments show good reconstruction of the quantitative T_1, T_2 maps, that are almost indistinguishable from the ones that are obtained when the ground-truth underlying physics are taken into account.

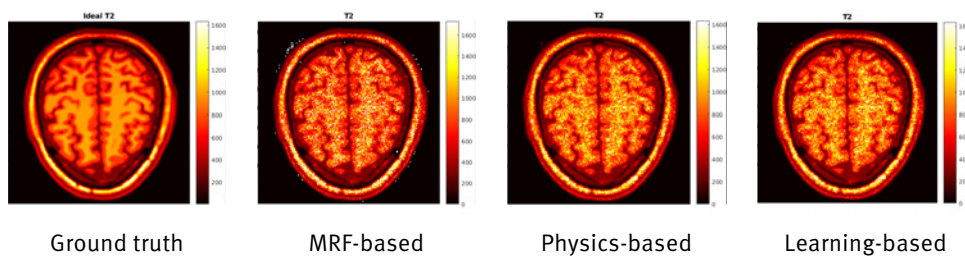

Fig. 2: Reconstruction of the T_2 map by substituting the Bloch solution map by a neural network

The applicability of the framework (1)–(2) was further corroborated by considering a general family of optimal control problems of semilinear elliptic PDEs with learning-informed constituents. Instead of directly learning the solution map of the PDE, the focus here is to substitute an unknown nonlinearity f via a neural network \mathcal{N} and embed this new learning-informed PDE into the optimal control problem.

More details about this research topic can be found in the corresponding Scientific Highlights article in this report on page 25.

Further highlights in 2020

The Covid-19 global pandemic has affected a series of planned events originally planned to take place during 2020 that are now scheduled to take place in 2021. The “15th International Conference on Free Boundary Problems” FBP2020 will take place on September 13–17, 2021, instead of September 2020. Michael Hintermüller is the Chair of the Organizing Committee with several members of the group being in the Local Support Team. Moreover, the MATH+ workshop on “Machine



Learning in Imaging Sciences: Bridging the Gap between Theory and Practice” originally planned for May 2020 will also take place during 2021, with RG 8 being the main organizer of the event.



The DFG Priority Program SPP 1962 *Non-smooth and Complementarity-based Distributed Parameter Systems: Simulation and Hierarchical Optimization* has been running successfully with a number of preprints (including three involving members of RG 8) and a planned annual meeting in early 2021. Furthermore, a special issue book collecting the research achievements of the first phase of the SPP is being compiled for publication under Birkhäuser, giving each project in the SPP an opportunity to condense and provide an overview of their work.



Furthermore, the group has three currently running projects in Berlin Mathematics Research Center MATH+, AA4-3 “Equilibria for energy markets with transport”, EF3-3 “Optimal transport for imaging”, and EF3-5 “Direct reconstruction of biophysical parameters using dictionary learning and robust regularization”, with a newly funded project “Decision-making for energy network dynamics” scheduled to begin in 2021. Additionally, Michael Hintermüller is a vice-speaker of the center and a scientist-in-charge of MATH+ Emerging Field 3 (EF3) Model-Based Imaging.



Early in the year, three members of the group participated in the workshop “Efficient Algorithms in Data Science, Learning and Computational Physics” in the Tsinghua Sanya International Mathematics Forum (TSIMF) in China, January 12–16, 2020. Michael Hintermüller was an invited speaker, and Guozhi Dong and Kostas Papafitsoros presented two posters. Furthermore, the workshop on “PDE Constrained Optimization under Uncertainty and Mean Field Games” took place in WIAS on January 28–30, 2020. Michael Hintermüller was among the organizers, and Caroline Geiersbach was an invited speaker. Together with Rüdiger Schultz (Duisburg–Essen), Caroline Geiersbach organized a session called “Algorithms for Stochastic Optimization Models beyond Convexity” at the DMV Annual Meeting, which was held virtually on September 14–17, 2020.

References

- [1] A. ALPHONSE, M. HINTERMÜLLER, C.N. RAUTENBERG, *Directional differentiability for elliptic quasi-variational inequalities of obstacle type*, Calc. Var., **58** (2019), pp. 39/1–39/47.
- [2] ———, *Optimal control and directional differentiability for elliptic quasi-variational inequalities*, WIAS Preprint no. 2756, 2020.
- [3] ———, *On the differentiability of the minimal and maximal solution maps of elliptic quasi-variational inequalities*, WIAS Preprint no. 2758, 2020.
- [4] G. DONG, M. HINTERMÜLLER, K. PAPAITSOROS, *Optimization with learning-informed differential equation constraints and its applications*, WIAS Preprint no. 2754, 2020.
- [5] C. GEIERSBACH, W. WOLLNER, *Optimality conditions for convex stochastic optimization problems in Banach spaces with almost sure state constraints*, WIAS Preprint no. 2755, 2020.

5 Flexible Research Platform

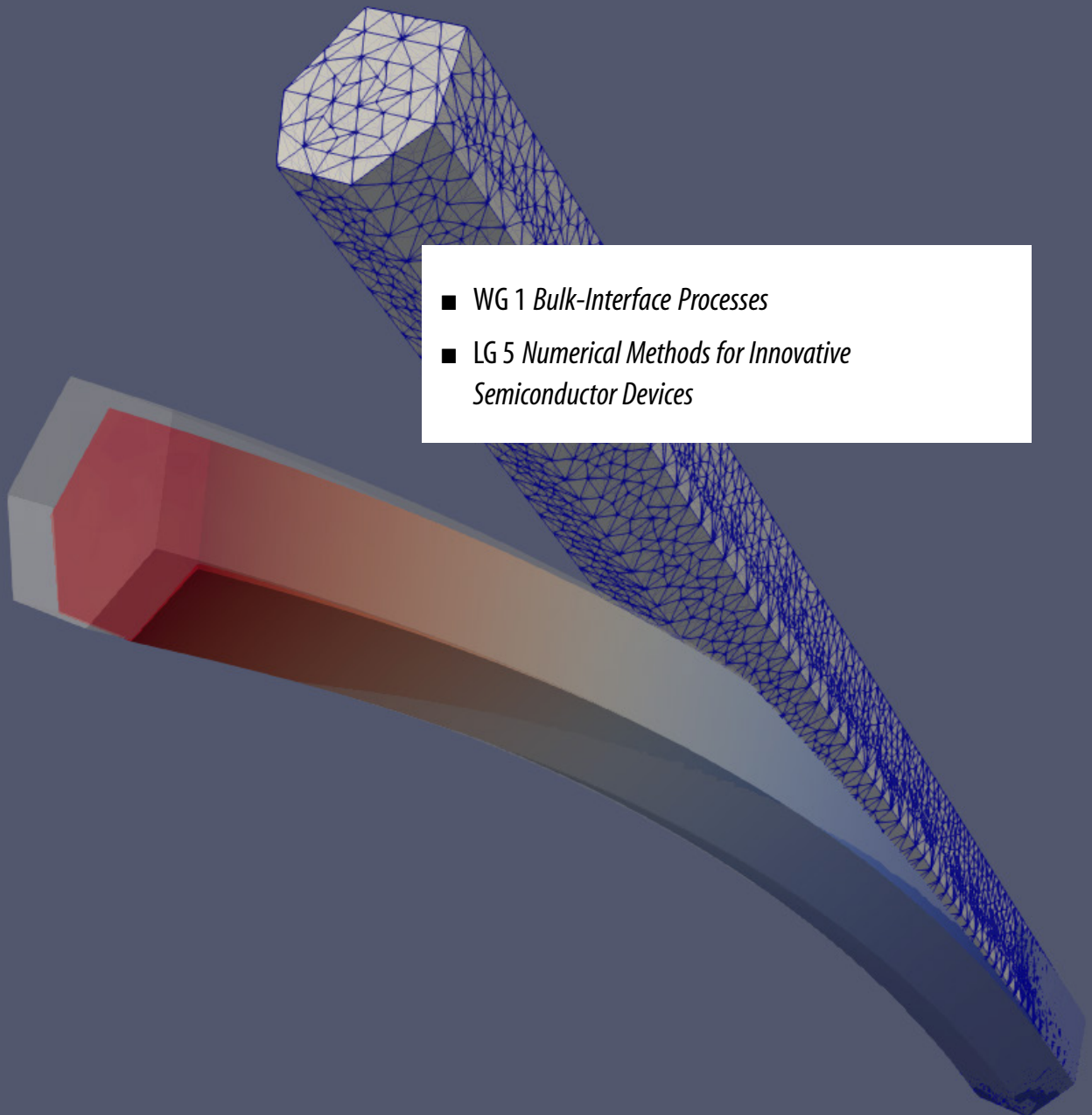

- WG 1 *Bulk-Interface Processes*
- LG 5 *Numerical Methods for Innovative Semiconductor Devices*

5.1 Weierstrass Group 1 “Modeling, Analysis, and Scaling Limits for Bulk-Interface Processes”

Head: Dr. Marita Thomas
Team: Priv.-Doz. Dr. Mohammad Hassan Farshbaf Shaker
 Dr. Dirk Peschka
 Sven Tornquist
 Andrea Zafferi
Secretary: Andrea Eismann



Fig. 1: Weierstrass Group in 2020, from left to right: M.H. Farshbaf-Shaker, A. Zafferi, S. Tornquist, M. Thomas, A. Eismann, D. Peschka

WG 1 was established as an element of the Flexible Research Platform at WIAS in April 2017, partially funded by WIAS budget resources. After a first successful period of three years, the group was positively evaluated in Spring 2020, and a second funding period of three more years was granted.

WG 1’s research goal consists in developing mathematical methods for systems with bulk-interface processes. This concerns the thermodynamically consistent modeling of bulk-interface interaction with dissipative, Hamiltonian, and coupled dynamics, the theory for the existence and qualitative properties of solutions, and the derivation and justification of interfacial evolution laws.

The analytical results form the basis for the development of numerical algorithms supporting simulations for applications with bulk-interface interaction. During the first funding period, WG 1 contributed with its research projects to the three WIAS main application areas *Nano- and Optoelectronics*, *Materials Modeling*, and *Flow and Transport*. Since the projects on mechanically strained optoelectronic devices are regarded as successfully closed for the time being, in the second funding period, starting from July 2020, the group continues and intensifies its research on applications within the areas *Materials Modeling* and *Flow and Transport*, in particular on:

- (1) dissipative processes in elastic solids with bulk-interface interaction, such as, e.g., damage, fracture, plastification, and
 - (2) multiphase flows with free boundaries,
- with the long term goal of directing the research within (1) and (2) towards applications in biology.

WG 1 also contributes to organizing the WIAS seminar on Materials Modeling and is a co-organizer of the Thematic Einstein Semester “Energy-Based Mathematical Modeling of Reactive Multiphase Flows” in winter term 2020/21.

In the following, a summary of the results and events within these two topics in 2020 is given:

Dissipative processes in elastic solids. The group is in particular engaged in the development and mathematical analysis of models for damage and fracture in elastically deformable solids both at small and at finite strains. The project “Reliability of efficient approximation schemes for material discontinuities described by functions of bounded variation” within the DFG-funded Priority Program 1748 *Reliable Simulation Techniques in Solid Mechanics. Development of Non-standard Discretisation Methods, Mechanical and Mathematical Analysis* studies the convergence of time- and space-discrete schemes for damage and fracture models with different types of coupled dynamics. Here, sufficient conditions for the convergence of fully discrete, approximate



solutions were designed, which can be implemented as stopping criteria for numerical algorithms. A careful analysis of the temporal regularity properties of the solutions for rate-independent phase-field fracture models for viscoelastic materials at small strains with wave propagation [1] revealed that viscosity of the displacements implies a higher temporal regularity also for the damage parameter: Its regularity is improved from being discontinuous in time to Hölder continuity in time. This improved regularity result is based on the notion of semistable energetic solutions for coupled rate-independent/rate-dependent processes in combination with specific convexity properties of the energy functional. Results of this type shall also be investigated in the nonlinear setting of dynamic fracture at finite strains, which is the topic of the newly granted project “Nonlinear fracture dynamics: Modeling, analysis, approximation, and applications” of Marita Thomas in collaboration with Kerstin Weinberg (Universität Siegen) and Christian Wieners (Karlsruhe Institute of Technology) within the Priority Program SPP 2256 *Variational Methods for Predicting Complex Phenomena in Engineering Structures and Materials* that saw its start in July 2020. Here, also the analytical results [2] for phase-field fracture models based on modified principal invariants will be of importance. The coupling of finite-strain elasticity with phase-field models is also of joint interest for WG 1 and RG 7 *Thermodynamic Modeling and Analysis of Phase Transitions* within the DFG-funded Priority Program 2171 *Dynamic Wetting of Flexible, Adaptive, and Switchable Substrates* with the aim to describe phase transitions in polymer gels using methods of gradient flows. In the realm of SPP 2256, WG 1 and RG 1 *Partial Differential Equations* jointly carried out the online-workshop *MA4M: Mathematical Analysis for Mechanics* on November 23–25, 2020; see page 133 for more details.

Multiphase flows with free boundaries. WG 1 develops mathematical methods for multiphase flows with a focus on free boundary problems, transport of mixtures and suspensions, and also aims at their extension to applications in geosciences, e.g., within project C09 “Dynamics of rock dehydration on multiple scales” in the DFG-funded CRC 1114 *Scaling Cascades in Complex Systems*.

Within the project “Mathematical modeling and simulation of substrate-flow interaction using generalized gradient flows” within the DFG-funded Priority Program 2171 *Dynamic Wetting of Flexible, Adaptive, and Switchable Substrates*, advanced mathematical methods for coupling fluid flow with non-trivial substrate dynamics are investigated, e.g., fluid-structure interaction, reactive surfaces, and coupling flow over porous substrates. This research includes joint work with Manuel Gnann (TU Delft) and Lorenzo Giacomelli (Sapienza Università di Roma) on novel models for contact line dynamics and with Luca Heltai (SISSA, Trieste) on fluid-structure interaction and higher-order methods for free boundary problems. The latter collaboration also led to a joint lecture series at the student compact course of the Thematic Einstein Semester 2020/21.

The research in the MATH+ project AA2-4 (01/19–12/20) focused on a continuum model for dense suspensions. It describes simple suspensions of rigid spheres immersed in a Newtonian fluid, where, besides hydrodynamic interactions and free surfaces, only simple external forces such as gravity are considered. From the mathematical point of view, this model for dense ??? contains several very challenging features: a highly nonlinear coupling of the variables, degeneracies of the material parameters, a constraint of non-negativity required for the densities, and in addition also non-standard, non-smooth terms in the dissipation potential. The work [3] succeeds in overcoming

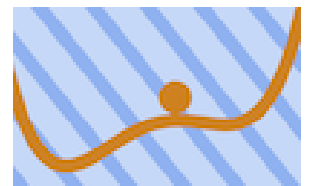

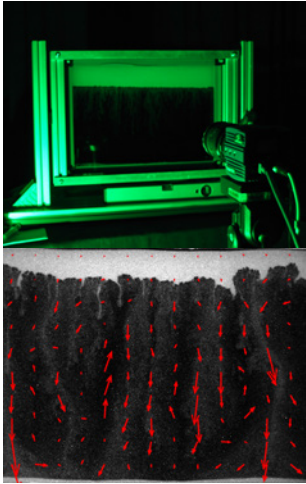

Fig. 2: (top) Hele-Shaw cell and (bottom) reconstructed flow field during particle sedimentation

the obstructions caused by the positivity requirement combined with the nonlinearities and degeneracies. This step turned out to be very challenging since the material laws of dense suspensions do not satisfy the assumptions required in literature to obtain the existence of global solutions with positivity results for the densities for models of fluid transport with degenerate material parameters. Instead, the results of [3] rely on a time-discretization combined with a Galerkin approximation in combination with a truncation method and a regularization of p -Laplacian type. In order to validate the model and to study the influence of the regularization, [4] investigates sedimentation experiments in a Hele-Shaw cell specifically built for this project at the Geoforschungszentrum Potsdam, see Figure 2, and compares it with numerical finite element simulations of this model. In one-dimensional experiments, it turned out that depending on the type of model and experiment, regularization of degenerate viscosities has an impact in the transition regions from dilute to dense suspension. The newly granted project AA2-9 “Variational methods for viscoelastic flows and gelation” (01/21–12/22) within MATH+ will build on these results of AA2-4 and provide a first step towards applications in biology.

Jointly with Volker Mehrmann from Technische Universität Berlin, RG 1 and RG 7, the WG 1 organized the Thematic Einstein Semester on “Energy-Based Mathematical Modeling of Reactive Multiphase Flows”, which included the organization of a series of workshops, conferences, seminars, student courses, and student projects held online in winter term 2020/21; see the Scientific Highlights article on page 36 for more details.

References

- [1] M. THOMAS, S. TORNQUIST, *Discrete approximation of dynamic phase-field fracture in viscoelastic materials*, WIAS Preprint no. 2798, 2020.
- [2] M. THOMAS, C. BILGEN, K. WEINBERG, *Analysis and simulations for a phase-field fracture model at finite strains based on modified invariants*, ZAMM Z. Angew. Math. Mech., **100** (2020), pp. e201900288/1–e201900288/51, DOI 10.1002/zamm.201900288
- [3] M.H. FARSHBAF SHAKER, M. THOMAS, *Analysis of a compressible Stokes-flow with degenerating and singular viscosity*, WIAS Preprint no. 2786, 2020.
- [4] D. PESCHKA, M. ROSENAU, *Two-phase flows for sedimentation of suspensions*, WIAS Preprint no. 2743, 2020.

5.2 Leibniz Group 5 “Numerical Methods for Innovative Semiconductor Devices”

Head: Dr. Patricio Farrell
Team: M.Sc. Dilara Abdel
Dr. Yiannis Hadjimichael
Dr. Stefan Kayser
Secretary: Marion Lawrenz

Leibniz Group 5 was established on WIAS’s Flexible Research Plattform in January 2020 after successfully winning a grant within the Leibniz competition. For five years, it is now funded by the Leibniz Association and covers two of WIAS’ main application areas: *Materials Modeling* and *Nano- and Optoelectronics*. The aim of this group is to develop partial differential equation (PDE) models as well as physics preserving numerical techniques for new semiconductor materials and technologies.

The following four specific research topics drive our research:

- Electro-mechanical models and simulations to understand transport in **bent nanowires**,
- The **lateral photovoltage scanning method** to detect fluctuations in crystals,
- Models and simulations of charge transport in **perovskites solar cells**,
- **Flux discretizations** for charge transport with nonlinear diffusion.

In the following, we present these applications in more detail.



Fig. 1: Leibniz Group 5 (left to right): Stefan Kayser, Yiannis Hadjimichael, Dilara Abdel, Patricio Farrell. Not in the picture: Marion Lawrenz.

Bent nanowires. Together with Christian Merdon and Timo Streckenbach (both Research Group RG 3 *Numerical Mathematics and Scientific Computing*), we are developing numerical techniques to simulate charge transport in bent nanowires. The difficulty is here to combine the nonlinear van

Roosbroeck system, which models charge transport in semiconductors, with an appropriate model from continuum mechanics to take into account the deformations.

Deriving and analyzing thermodynamically consistent models describing charge-carrier transport in mechanically deformed semiconductors will be the topic of the recently accepted MATH+ project “Electro-mechanical coupling for semiconductor devices”. Apart from LG 5, this project involves Matthias Liero and Annegret Glitzky (both Research Group RG 1 *Partial Differential Equations*) as well as Barbara Zwicknagl from Humboldt-Universität zu Berlin.

Nanowires are so thin that quantum effects might need to be considered. For this reason, we investigate together with researchers from Tyndall National Institute (Ireland) and Thomas Koprucki (RG 1) how to combine random atomic fluctuations in band edges with macroscale drift-diffusion processes. To this end, spatially randomly varying band edges were implemented in `ddfermi` [5].

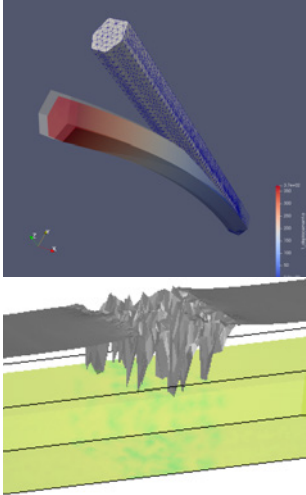

The lateral photovoltage scanning method. In order to improve the crystal growth design, it is crucial to predict the temperature distribution in the furnace and, especially, in the growing crystal. Unfortunately, it is impossible to measure the temperature distribution during crystal growth without damaging the crystal structure and introducing impurities. Moreover, silicon, for example, melts at extremely high temperatures, around $1,687\text{ K}$.

However, microscopic variations in the crystal appear along the solid-liquid interface during growth. These can be measured even in the cooled-down crystal and correspond to isothermal contour lines of the temperature field. The *lateral photovoltage scanning* method (LPS) helps to visualize these variations with a laser by creating a voltage difference at the sample edges, which is proportional to the microscopic variations.

Together with Nella Rotundo from the University of Florence and Natascha Dropka from the Leibniz-Institut für Kristallzüchtung, Stefan Kayser and Patricio Farrell developed a mathematical understanding for this opto-electronic measurement technique through appropriate modeling and simulation within the MATH+ incubator project IN-B3 “Understanding doping variations in silicon crystals”.

Our open-source code reduces the simulation time by two orders of magnitude. This is crucial since a future aim is to efficiently solve the corresponding inverse problem. Moreover, our method presented here also works well for very low doping concentrations, which previously could not be simulated due to numerical instabilities. We also present a convergence study showing that the LPS voltage converges quadratically [3, 4].

Perovskites solar cells. In recent years, perovskite solar cells (PSCs) have become one of the fastest growing technologies within photovoltaics. Two advantages of PSCs stand out: On the one hand, certain architectures have significantly lower production costs than conventional solar cells. On the other hand, in 2020, silicon-perovskite tandem cells have become more efficient than classical single junction silicon solar cells. A record efficiency of 29.15% has been demonstrated. Further efficiency gains are likely. However, the commercialization of PSCs is still in its early stages, and several challenges need to be overcome: Commercially viable PSCs degrade significantly faster. Also some PSCs rely on environmentally unfriendly materials such as lead (Pb).

Berlin Mathematics Research Center
MATH+

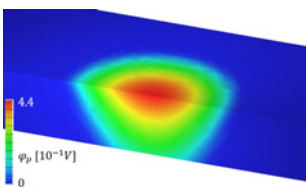

Dilara Abdel and Patricio Farrell are working together with Petr Vágner and Jürgen Fuhrmann (both RG 3) on deriving models and simulations for PSCs. The idea is to derive, from Maxwell–Stefan diffusion and general electrostatics, a drift-diffusion model for charge transport in perovskite solar cells (PSCs) where any ion in the perovskite layer may flexibly be chosen to be mobile or immobile. Unlike other models in the literature, our model is based on quasi-Fermi potentials instead of densities. This allows to easily include nonlinear diffusion (based on, for example, Fermi–Dirac, Gauss–Fermi or Blakemore statistics) as well as limit the ion vacancy depletion (via the Fermi–Dirac integral of order -1). The latter is motivated by a grand-canonical formalism of ideal lattice gas. Furthermore, our model allows to use different statistics for different species [1].

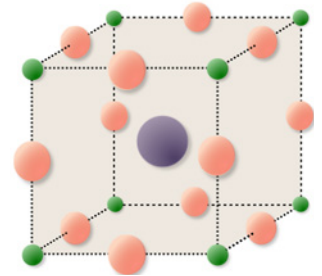

Flux discretizations. LG 5 is also investigating flux approximations for the nonlinear diffusion arising in the van Roosbroeck system. To this end, the excess chemical potential flux scheme was recently compared to other state-of-the-art flux approximation schemes within a Voronoi finite volume discretization [2]. Dilara Abdel's work belonged to the top ten submissions at the *20th International Conference on Numerical Simulation of Optoelectronic Devices* which took place virtually.

References

- [1] D. ABDEL, P. VAGNER, J. FUHRMANN, P. FARRELL, *Modelling charge transport in perovskite solar cells: Potential-based and limiting ion vacancy depletion*, WIAS Preprint no. 2780, 2020.
- [2] D. ABDEL, P. FARRELL, J. FUHRMANN, *Assessing the quality of the excess chemical potential flux scheme for degenerate semiconductor device simulation*, WIAS Preprint no. 2787, 2020.
- [3] P. FARRELL, S. KAYSER, N. ROTUNDO, *Modeling and simulation of the lateral photovoltage scanning method*, WIAS Preprint no. 2784, 2020.
- [4] S. KAYSER, P. FARRELL, N. ROTUNDO, *Detecting striations via the lateral photovoltage scanning method without screening effect*, WIAS Preprint no. 2785, 2020.
- [5] S. SCHULZ, D. CHAUDHURI, M. O'DONOVANA, S.K. PATRA, T. STRECKENBACH, P. FARRELL, O. MARQUARDT, T. KOPRUCKI, *Multi-scale modeling of electronic, optical, and transport properties of III-N alloys and heterostructures*. in: SPIE Photonics West, 11274 (2020), pp. 157–166. <http://doi.org/10.1117/12.2551055>.

A Facts and Figures

(In the sequel, WIAS staff members are underlined.)

- Offers, Awards, Ph.D. Theses, Supervision
- Grants
- Membership in Editorial Boards
- Conferences, Colloquia, and Workshops
- Membership in Organizing Committees of non-WIAS Meetings
- Publications
- Preprints, Reports
- Talks and Posters
- Visits to other Institutions
- Academic Teaching
- Visiting Scientists
- Guest Talks
- Software

A.1 Professorships, Awards, Ph.D. Theses, Supervision

A.1.1 Offers of Professorships

1. L. TAGGI, W1 Professorship, October 15, Sapienza Università di Roma, Dipartimento di Matematica.

A.1.2 Awards and Distinctions

1. R. HENRION, *Member of Comité Scientifique International, Groupement de Recherche Mathématiques de l'Optimisation et Applications (GdR MOA), France.*
2. M. HINTERMÜLLER, *Co-chair and Member of the Council of the Berlin Mathematics Research Center MATH+.*
3. ———, *Member of the Integrative Research Institute for the Sciences IRIS Adlershof of the Humboldt-Universität zu Berlin.*
4. ———, *Member of the Scientific Advisory Board of the INM – Leibniz-Institut für Neue Materialien, Saarbrücken.*
5. ———, *Spokesperson of Forschungsverbund Berlin e.V.*
6. ———, *Spokesperson of Section 4, Technical Sciences and Engineering, of the initiative Berlin Research 50.*
7. D. HÖMBERG, *Chair of the European Consortium for Mathematics in Industry (ECMI)'s Research and Innovation Committee.*
8. ———, *Head of the Secretariat of the International Mathematical Union (IMU).*
9. ———, *Treasurer of IMU.*
10. ———, *Vice Chair of 7th Technical Committee (TC7) of the International Federation for Information Processing (IFIP) on System Modeling and Optimization.*
11. K. HOPE, *Faculty Thesis Prize Winner 2020 (Mathematics) by University of Warwick (Faculty of Science), July 9.*

A.1.3 Defenses of Ph.D. Theses

1. N. BUZUN, *Bootstrap in high dimensional spaces*, Humboldt-Universität zu Berlin, Mathematisch-Naturwissenschaftliche Fakultät, supervisor: Prof. Dr. V. Spokoiny, December 11.
2. K. EFIMOV, *Adaptive nonparametric clustering*, Humboldt-Universität zu Berlin, Mathematisch-Naturwissenschaftliche Fakultät, supervisor: Prof. Dr. V. Spokoiny, May 12.
3. M. MARSCHALL, *Explicit and adaptive Bayesian inversion in hierarchical tensor format*, Technische Universität Berlin, Fakultät II – Mathematik und Naturwissenschaften, supervisors: Prof. Dr. D. Hömberg, Dr. M. Eigel, October 5.
4. L. BLANK, *Analytical and numerical aspects of porous media flow*, Freie Universität Berlin, Fachbereich Mathematik und Informatik, supervisor: Dr. A. Caiazzo, February 14.
5. C. GEIERSBACH, *Stochastic approximation for PDE-constrained optimization under uncertainty*, Universität Wien, Fakultät für Wirtschaftswissenschaften, supervisor: Univ.-Prof. Mag. Dr. G. Pflug, May 20.
6. A. JHA, *Numerical algorithms for algebraic stabilizations of scalar convection-dominated problems*, Freie Universität Berlin, Fachbereich Mathematik und Informatik, supervisor: Prof. Dr. V. John, October 16.

A.1.4 Supervision of Undergraduate Theses

1. F. ASSION, *A convergence analysis of the Landweber iteration for deterministic and statistical non-linear ill-posed inverse problems* (master's thesis), Humboldt-Universität zu Berlin, Mathematisch-Naturwissenschaftliche Fakultät, supervisors: Prof. Dr. M. Reiß, [Dr. A. Kröner](#), April 30.
2. T. BURG, *Curvature based remeshing for phase field based topology optimization* (master's thesis), Technische Universität Berlin, Fakultät II – Mathematik und Naturwissenschaften, supervisor: [Prof. Dr. D. Hömberg](#), March 5.
3. Y. DING, *Adaptive methods for convection-diffusion equations* (master's thesis), Freie Universität Berlin, Fachbereich Mathematik und Informatik, supervisor: [Prof. Dr. V. John](#), February 10.
4. N. HERBERS, *Optimale Steuerung des Koeffizienten einer elliptischen Gleichung mit Zustandsbeschränkung und Anwendung in der Modellierung von Kabelbettungen* (bachelor's thesis), Humboldt-Universität zu Berlin, Mathematisch-Naturwissenschaftliche Fakultät, supervisor: [Dr. A. Kröner](#), March 17.
5. A. KLEPOCH, *Energieoptimale Steuerung des Orbittransferproblems* (bachelor's thesis), Technische Universität Berlin, Fakultät II – Mathematik und Naturwissenschaften, supervisor: [Prof. Dr. D. Hömberg](#), October 11.
6. H. KNOF, *Branch and Bound in der nichtlinearen globalen Optimierung am Beispiel eines Packproblems* (bachelor's thesis), Technische Universität Berlin, Fakultät II – Mathematik und Naturwissenschaften, supervisor: [Prof. Dr. D. Hömberg](#), December 6.
7. M. LIU, *Eddy viscosity models in variational multiscale methods for turbulent flow simulations* (master's thesis), Freie Universität Berlin, Fachbereich Mathematik und Informatik, supervisor: [Prof. Dr. V. John](#), January 31.
8. K. NIKITINA, *Große Abweichungen eines Koagulationsprozesses* (master's thesis), Technische Universität Berlin, Fakultät II – Mathematik und Naturwissenschaften, supervisors: [Prof. Dr. W. König](#), [Dr. R.I.A. Patterson](#), February 5.
9. I. PERKO, *Convergence of adaptive finite element methods for the Poisson problem* (master's thesis), Freie Universität Berlin, Fachbereich Mathematik und Informatik, supervisor: [Prof. Dr. V. John](#), September 2.
10. S.M. PHAM, *Charakteristika zufälliger Kachelungen* (master's thesis), Technische Universität Berlin, Fakultät II – Mathematik und Naturwissenschaften, supervisors: [Dr. B. Jahnel](#), [Prof. Dr. W. König](#), October 20.
11. F. PICHELBAUER, *Trust-Region Verfahren* (bachelor's thesis), Technische Universität Berlin, Fakultät II – Mathematik und Naturwissenschaften, supervisor: [Prof. Dr. D. Hömberg](#), July 20.
12. M. SCHMIDT, *Partikelmodelle mit Koagulation* (master's thesis), Technische Universität Berlin, Fakultät II – Mathematik und Naturwissenschaften, supervisors: [Prof. Dr. W. König](#), [Dr. R.I.A. Patterson](#), November 6.
13. A. SCHWERICKE, *Manifold learning as preprocessor for nonparametric clustering* (bachelor's thesis), Technische Universität Berlin, Fakultät II – Mathematik und Naturwissenschaften, supervisors: [Prof. Dr. P. Friz](#), [Prof. Dr. V. Spokoiny](#), October 26.
14. H. SHAFIGH, *Fluktuationen und Abweichungen einer stochastischen Differentialgleichung* (bachelor's thesis), Technische Universität Berlin, Fakultät II – Mathematik und Naturwissenschaften, supervisors: [Prof. Dr. W. König](#), [Prof. Dr. J.-D. Deuschel](#), May 5.
15. C. SIROTENKO, *Optimal choice of spatially adaptive parameters in total generalized variation via bilevel optimization with applications to Fourier inpainting* (master's thesis), Humboldt-Universität zu Berlin, Mathematisch-Naturwissenschaftliche Fakultät, supervisors: [Prof. Dr. M. Hintermüller](#), [Dr. K. Papafitsoros](#), October 8.

16. D. ABDEL, *Comparison of flux discretizations for generalized drift-diffusion systems* (master's thesis), Technische Universität Berlin, Fakultät II – Mathematik und Naturwissenschaften, supervisors: Dr. P. Farrell, Dr. J. Fuhrmann, October 7.

A.2 Grants¹

European Union, Brussels

■ Seventh Framework Programme

ERC Consolidator Grant “GPSART – Geometric Aspects in Pathwise Stochastic Analysis and Related Topics” (Prof. P. Friz in RG 6)

The project ERC-2015-CoG no. 683164 takes part in RG 6 and is funded for the duration from September 2016 to August 2021. Its purpose is to study a number of important problems in stochastic analysis, including the transfer of rough paths ideas to Hairer’s regularity structures, the study of rough volatility in quantitative finance, a pathwise view on stochastic Loewner evolution, and an understanding of the role of geometry in the pathwise analysis of fully nonlinear evolution equations. This project is run jointly with the Technische Universität Berlin.

■ Marie Skłodowska-Curie Actions: Innovative Training Networks (ITN)

“ROMSOC – Reduced Order Modelling, Simulation and Optimization of Coupled systems” (in RG 8)

The subproject “Optimal shape design of air ducts in combustion engines” (ROMSOC-ESR11) is treated in RG 8 jointly with Math. Tec GmbH, Austria, until March 4, 2021. The research aims to determine optimal shapes of regions of interest in order to minimize the number of suitable objectives subject to fluid flow.



Bundesministerium für Bildung und Forschung (Federal Ministry of Education and Research), Bonn

■ Mathematik für Innovationen (Mathematics for innovations)

“Modellbasierte Abschätzung der Lebensdauer von gealterten Li-Batterien für die 2nd-Life Anwendung als stationärer Stromspeicher (MALLi²)” (Model-based assessment of the life span of aged Li batteries for second-life use for stationary energy storage (MALLi²); in RG 7)

The project is coordinated by collaborators of RG 7. It aims to improve the lifetime estimation of lithium-ion batteries from electric vehicles for their continued use as stationary energy storage devices.

■ Förderprogramm IKT 2020 – Forschung für Innovationen (Funding program for information and communication technologies 2020 – research and innovations)

“Berliner Zentrum für Maschinelles Lernen (BZML)” (Berlin Center for Machine Learning), Technische Universität Berlin

The center aims at the systematic and sustainable expansion of interdisciplinary machine learning research, both in proven research constellations as well as in new, highly topical scientific objectives that have not yet been jointly researched. WIAS collaborates in the subproject “Adaptive topological data analysis” (in RG 6).

■ Energy and Climate Fund of the German Federal Government

Verbundvorhaben “LuCaMag – Wege zu sekundären Mg/Ca-Luft-Batterien” (joint project: LuCaMag – Ways to secondary Mg/Ca-air batteries; in RG 3 and RG 7)

WIAS (RG 3 and RG 7) participates in the joint project “Ways to secondary Mg/Ca-air batteries”. They work on the subproject “Continuum based modeling”. The interdisciplinary project is coordinated by the Chair of Electrochemistry of Universität Bonn. Further partners are the Chair of Theoretical Chemistry of Universität Bonn, the Institute of Surface Chemistry and Catalysis of Universität Ulm, and the Center of Solar and Hydrogen Research (ZSW) in Ulm. WIAS supports the interpretation of experimental results by continuum based modeling and simulation. Further, WIAS plans to use results from measurements and quantum chemical

¹The research groups (RG) involved in the respective projects are indicated in brackets.

computations performed by project partners to obtain parameters for the thermodynamically well founded electrolyte models developed in RG 7.

Deutsche Forschungsgemeinschaft (DFG, German Research Foundation), Bonn

■ **Excellence Strategy of the Federal and the State Governments (DFG)**

The Berlin Mathematics Research Center MATH+

The highlight of the collaboration with the mathematical institutions in Berlin since January 2019 was the joint operation of the Berlin Mathematics Research Center MATH+.

MATH+ is a cross-institutional and transdisciplinary Cluster of Excellence with the aim to explore and further develop new approaches in application-oriented mathematics. Emphasis is placed on mathematical principles for using ever larger amounts of data in life and material sciences, in energy and network research, and in the humanities and social sciences. The Research Center is funded by the DFG for a first period of seven years since January 2019. It is a joint project of Freie Universität Berlin, Humboldt-Universität zu Berlin, Technische Universität Berlin, WIAS, and the Zuse Institute Berlin (ZIB). MATH+ continues the success stories of the renowned Research Center MATHEON and the Excellence-Graduate School Berlin Mathematical School (BMS).

In 2020, WIAS dedicated considerable financial and personal resources to the Center: Its director, Prof. M. Hintermüller (RG 8) was one of the three spokespersons and a member of the Executive Board of MATH+. He and Prof. W. König (RG 5), Prof. P. Friz (RG 6), Prof. V. Spokoyny (RG 6), and Dr. M. Thomas (WG 1) were members of the MATH+ Council; Prof. A. Mielke (RG 1), Scientist in Charge of the Application Area AA2 “Materials, Lights, Devices”, Prof. M. Hintermüller (RG 8) and Prof. V. Spokoyny (RG 6) Scientists in Charge of the Emerging Field EF3 “Model-based Imaging”, and Prof. P. Friz (RG 6) and Prof. W. König Scientists in Charge of the Emerging Field EF4 “Particles and Agents”; and WIAS members participated in the successful running of the following subprojects:

AA2-1 “Hybrid models for the electrothermal behavior of organic semiconductor devices” (in RG 1)

AA2-3 “Quantum-classical simulation of quantum dot nanolasers” (in RG 2)

AA2-4 “Modeling and analysis of suspension flows” (in WG 1 and RG 7)

AA2-5 “Data-driven electronic structure calculations for nanostructures” (in RG 1)

AA2-6 “Multi-material electrocatalysis” (in RG 3 and RG 7)

AA4-1 “PDAEs with uncertainties for the analysis, simulation and optimization of energy networks” (in RG 4)

AA4-2 “Optimal control in energy markets using rough analysis and deep networks” (in RG 6)

AA4-3 “Equilibria for energy markets with transport” (in RG 8)

EF1-5 “On robustness of deep neural networks” (in RG 6)

EF2-4 “Conforming regular triangulations” (in RG 3)

EF3-1 “Model-based geometry reconstruction from TEM images” (in RG 1 and RG 6)

EF3-3 “Optimal transport for imaging” (in RG 6 and RG 8)

EF3-5 “Direct reconstruction of biophysical parameters using dictionary learning and robust regularization” (in RG 8)

EF4-1 “Influence of mobility on connectivity” (in RG 5)

IP-TB-3 “Understanding doping variations in silicon crystals” (in LG 5)

Approved projects, starting in 2021:

AA1-12: “Mathematical modeling of cellular self-organization of stimuli responsive extra cellular matrix” (in RG 7)

AA2-9 “Variational methods for viscoelastic flows and gelation” (in WG 1 and RG 7)

AA2-10 “Electromechanical coupling for semiconductor devices” (in RG 1 and LG 5)

AA2-12 “Nonlinear electrokinetics in anisotropic microfluids – Analysis, simulation, and optimal control” (in RG 4)

AA2-13 “Modeling and optimization of semiconductor lasers for quantum metrology applications” (in RG 2)

AA2-15 “Random alloy fluctuations in semiconductors” (in RG 1 and RG 6)

AA4-7 “Decision-making for energy network dynamics” (in RG 8)

AA4-8 “Recovery of battery ageing dynamics with multiple timescales” (in RG 1, RG 4, and RG 7)

EF1-13 “Stochastic and rough aspects in deep neural networks” (in RG 6)

EF3-8 “Analysis of brain signals by Bayesian Optimal Transport” (in RG 6)

EF3-9 “Mathematical framework for MR poroelastography” (in RG 3 and RG 6)

EF4-10 “Trail formation in populations of auto-chemotactic agents” (in RG 5)

- **Collaborative Research Center/Transregio (TRR) 154: “Mathematische Modellierung, Simulation und Optimierung am Beispiel von Gasnetzwerken” (Mathematical Modeling, Simulation and Optimization Using the Example of Gas Networks)**, Friedrich-Alexander-Universität Erlangen-Nürnberg



This transregio research center, funded by the DFG since October 2014, has successfully been reviewed for the second phase, and the funding was extended until June 2022. The research center focuses on an efficient handling of gas transportation. The Weierstrass Institute participates in the subprojects “Chance constraints in models of gas markets” (in RG 4), “Multicriteria optimization subject to equilibrium constraints at the example of gas markets”, and “Galerkin methods for the simulation, calibration, and control of partial differential equations on networks” (both in RG 8).

- **Collaborative Research Center (SFB) 910: “Kontrolle selbstorganisierender nichtlinearer Systeme: Theoretische Methoden und Anwendungskonzepte” (Control of Self-organizing Nonlinear Systems: Theoretical Methods and Concepts of Application)**, Technische Universität Berlin



In 2019, the SFB started with its third and last funding period. This interdisciplinary SFB combines groups from theoretical physics, applied mathematics, and computational neuroscience from four universities and research institutes in Berlin. WIAS participates with two subprojects. Subproject A3 “Self-organization and control in coupled networks and time-delayed systems” in RG 2 is focused on high-dimensional dynamics and localization phenomena in complex network systems and delay differential equations. Subproject A5 “Pattern formation in coupled parabolic systems” in RG 1 studies pattern formation in reaction-diffusion systems and in models of fluid dynamics.

- **Collaborative Research Center (SFB) 1114: “Skalenkaskaden in komplexen Systemen” (Scaling Cascades in Complex Systems)**, Freie Universität Berlin



The center began its work on October 1, 2014 (second funding period until June 30, 2022). WIAS members participate in the subprojects: B01 “Fault networks and scaling properties of deformation accumulation” (in RG 1, with FU Berlin and GFZ Potsdam), C02 “Interface dynamics: Bridging stochastic and hydrodynamic descriptions” (in RG 1, with FU Berlin), C05 “Effective models for materials and interfaces with multiple scales” (in RG 1), C08 “Stochastic spatial coagulation particle processes” (in RG 5), and C09 “Dynamics of rock dehydration on multiple scales” (in WG 1 with FU Berlin).



- **Collaborative Research Center (SFB) 1294: “Datenassimilation: Die nahtlose Verschmelzung von Daten und Modellen” (Data Assimilation – The Seamless Integration of Data and Models)**, Universität Potsdam

This center started in July 2017 for four years. It is coordinated by Universität Potsdam together with HU Berlin, TU Berlin, WIAS, Geoforschungszentrum Potsdam, and Universität Magdeburg. The research is focused on the seamless integration of large data sets into sophisticated computational models. When the computational model is based on evolutionary equations and the data set is time ordered, the process of combining models and data is called *data assimilation*.

The subproject A06 “Approximative Bayesian inference and model selection for stochastic differential equations (SDEs)” is carried out jointly between the TU Berlin, with the focus on variational Bayesian methods on combined state and drift estimation for SDEs, WIAS (in RG 6), on prior selection for semi- and non-parametric statistics applied to SDEs, and the Universität Potsdam, on sequential Monte Carlo methods for high-dimensional inference problems arising from SDEs.



- **Priority Program SPP 1590: “Probabilistic Structures in Evolution”**, Universität Bielefeld

This interdisciplinary nationwide priority program aims at the development of new mathematical methods for the study and understanding of an innovative evolution biology. In the prolongation of the subproject “Branching processes in random environment and their application to population genetics” for 2016–2020 (in RG 5), the interest was concentrated in 2020 on the analysis of branching processes in random environments on particular discrete structures like the hypercube and random graphs with certain asymptotic degree structure.



- **Priority Program SPP 1679: “Dyn-Sim-FP – Dynamische Simulation vernetzter Feststoffprozesse” (Dynamic Simulation of Interconnected Solids Processes)**, Technische Universität Hamburg-Harburg

WIAS participated in this priority program with the subproject “Numerische Lösungsverfahren für gekoppelte Populationsbilanzsysteme zur dynamischen Simulation multivariater Feststoffprozesse am Beispiel der formselektiven Kristallisation” (Numerical methods for coupled population balance systems for the dynamic simulation of multivariate particulate processes using the example of shape-selective crystallization; in RG 3). The project aimed at assessing and improving numerical methods for population balance systems. In particular, a coupled stochastic-deterministic method for solving population balance systems was developed.



- **Priority Program SPP 1748: “Zuverlässige Simulationstechniken in der Festkörpermechanik – Entwicklung nichtkonventioneller Diskretisierungsverfahren, mechanische und mathematische Analyse” (Reliable Simulation Techniques in Solid Mechanics – Development of Non-standard Discretisation Methods, Mechanical and Mathematical Analysis)**, Universität Duisburg-Essen

WG 1 participated in this priority program with the subproject “Finite-Elemente-Approximation von Funktionen beschränkter Variation mit Anwendungen in der Modellierung von Schädigung, Rissen und Plastizität” (Finite element approximation of functions of bounded variation and application to models of damage, fracture, and plasticity), which is a collaboration with Universität Freiburg (duration: Oct. 2014 – Sept. 2017) and currently participates, also jointly with Universität Freiburg, from December 2017 to September 2021 in the subproject “Reliability of efficient approximation schemes for material discontinuities described by functions of bounded variation”.



- **Priority Program SPP 1886: “Polymorphe Unschärfemodellierungen für den numerischen Entwurf von Strukturen” (Polymorphic Uncertainty Modelling for the Numerical Design of Structures)**, Technische Universität Dresden

RG 4 participates in this priority program with the subproject “Multi-scale failure analysis with polymorphic uncertainties for optimal design of rotor blades”, which is a collaboration with Prof. Yuriy Petryna at the TU Berlin. Main goals of the project are a possibilistic-probabilistic modeling of an adhesion layer described by a non-periodic random microstructure, and the numerical upscaling to a macroscopic random representation.

- **Priority Program SPP 1962: “Nichtglatte Systeme und Komplementaritätsprobleme mit verteilten Parametern: Simulation und mehrstufige Optimierung” (Non-smooth and Complementarity-based Distributed Parameter Systems: Simulation and Hierarchical Optimization)**, Humboldt-Universität zu Berlin



The Director of WIAS, Prof. Michael Hintermüller, is the coordinator of this priority program that was started in October 2016 with the aim to help solve some of the most challenging problems in the applied sciences that involve nondifferentiable structures as well as partial differential operators, thus leading to nonsmooth distributed parameter systems. The second funding period until 2022 started in 2019.

WIAS participates in the second funding period with the subprojects “A non-smooth phase-field approach to shape optimization with instationary fluid flow” (from 01.07.2019), “Constrained mean field games: Analysis and algorithms” (from 01.07.2019), and “A unified approach to optimal uncertainty quantification and risk-averse optimization with quasi-variational inequality constraints” (from 01.07.2019) (all in RG 8).

- **Priority Program SPP 2171: “Dynamic Wetting of Flexible, Adaptive, and Switchable Substrates”**, Universität Münster



The dynamic process of liquids that wet or dewet substrates is relevant in nature and for many technological applications. Processes that involve lubrication, adhesives, or surface coatings, depend on the dynamics of wetting processes. Recent developments in areas like microelectronics or three-dimensional printing demonstrated the need to also understand cases in which the hydrodynamics and substrate dynamics are strongly coupled. This holds true especially on microscopic and mesoscopic length scales, where (non-)equilibrium surface phenomena dominate.

WIAS participates in this first funding period with the two subprojects “Mathematische Modellierung und Simulation der Wechselwirkung von Substraten mit Strömungen durch verallgemeinerte Gradientenflüsse” (Mathematical modeling and simulation of substrate-flow interaction using generalized gradient flows; in WG 1; duration Sep. 2019 – Aug. 2022) and the tandem project “Dynamisches Benetzen und Entnetzen von viskosen flüssigen Tropfen/Filmen auf viskoelastischen Substraten” (Dynamic wetting and dewetting of viscous liquid droplets/films on viscoelastic substrates; in RG 7) in cooperation with Ralf Seemann (Universität des Saarlandes; duration: Jan. 2020 – Dec. 2022).

- **Priority Program SPP 2256 “Variationelle Methoden zur Vorhersage komplexer Phänomene in Strukturen und Materialien der Ingenieurwissenschaften” (Variational Methods for Predicting Complex Phenomena in Engineering Structures and Materials)**, Universität Regensburg

The aim of this priority program, whose first funding period started in July 2020, is the development of analytical and numerical tools for the solution of problems in the continuum mechanics of solids. The research in the priority program is grouped in three major research directions: multiscale and multiphysics problems, coupling of dimensions, and evolution of microstructure. Within this general scope, mathematical tools from the field of variational analysis are of great interest. They include the theories of homogenization, relaxation, Γ -convergence and variational time evolution. WIAS contributes to the priority program with three projects: “Fractal and stochastic homogenization using variational methods” and “Analysis for thermo-mechanical models with internal variables” (both in RG 1) as well as “Nonlinear fracture dynamics: Modelling, analysis, approximation and applications” (WG 1 with Universität Siegen and Karlsruhe Institute of Technology).

Approved Project:

- **Priority Program SPP 2265 “Zufällige geometrische Systeme” (Random Geometric Systems)**, WIAS

The head of RG 5, Prof. Wolfgang König, is the head of this priority programme, which aims at solving various problems that originate from a counterplay between randomness and space. There are many motivations from rich applications in the Sciences, but also intrinsic interest from researchers in probability. The first funding period officially started in October 2020.

WIAS participates with the projects “Spatial coagulation and gelation” and “The statistical mechanics of the interlacement process” (in RG 5). For more information see <https://spp2265.wias-berlin.de/>.



■ **Research Unit FOR 2402 “Rough Paths, Stochastic Partial Differential Equations and Related Topics”, Technische Universität Berlin**

The first phase of this research unit has been funded since 2016, the second phase since 2019. One of the two spokesmen is Prof. Peter Friz (RG 6). The unit works on innovative methods for applying rough path theory to the analysis of stochastic partial differential equations (SPDEs), like rough flow transformations, paracontrolled distributions, and regularity structures, to push forward the understanding of the solution theory of various types of SPDEs and the analysis of the most important physical properties of the solution processes.

The central theme in the subproject TP 3 “Numerische Analysis von rauen partiellen Differentialgleichungen” (Numerical analysis of rough PDEs; in RG 6) are numerical techniques for PDEs driven by deterministic or random rough paths, namely the application of semi-group theory to rough PDEs connected with Galerkin finite element methods and Feynman–Kac representations combined with spatial regression, aiming at the development of new implementable numerical methods, their error analysis, and computational complexity.

In the subproject TP5 “Singular SPDEs – Approximation and statistical properties” (in RG 5), two important and prominent types of equations are studied – the Kardar–Parisi–Zhang (KPZ) equation and the (time-dependent) parabolic Anderson equation. The main goal is the investigation of their most important long-time properties like ageing for the KPZ equation and intermittency of the Anderson equation.

■ **GAČR-DFG Cooperation: Joint German-Czech Research Projects**

“Electrochemical double layers in solid oxide cells (EDLSOC)” (in RG 3): This is a joint project of the Weierstrass Institute and the University of Chemistry and Technology, Prague, Czechia. The main goal of the EDLSOC project is to establish a detailed, experimentally validated thermodynamic description of the interface processes occurring in the electrodes of solid oxide cells. Model development and comparison to experimental data is supported by numerical models.

■ **RFBR-DFG Cooperation: Joint German-Russian Research Projects**

Approved Project:

“Collective dynamics of heterogeneous networks of active elements” (in RG 2): The project was established jointly with the Institute of Applied Physics of the Russian Academy of Sciences (Nishny Novgorod) and is devoted to the investigation of the dynamics of large networks of active elements. However, due to the pandemic situation, all traveling activities planned for 2020 had to be cancelled, and the beginning of the project was shifted to 2021.

■ **Normalverfahren (Individual Grants)**

Approved Project:

“Nichtlineare Dynamik in hybriden SOA-Faserlaser-Systemen mit Rückkopplung” (Nonlinear dynamics in hybrid SOA fiber laser systems with feedback; in RG 2)

■ **Eigene Stelle (Temporary Positions for Principal Investigators)**

“Mathematische Modellierung und Simulation der Wechselwirkung von Substraten mit Strömungen durch verallgemeinerte Gradientenflüsse” (Mathematical modeling and simulation of substrate-flow interaction using generalized gradient flows; see SPP 2171, Dr. D. Peschka)

Approved Project:

“Fraktale und stochastische Homogenisierung mithilfe variationeller Methoden” (Fractal and stochastic homogenization using variational methods; see SPP 2256, Dr. M. Heida)

Leibniz-Gemeinschaft (Leibniz Association), Berlin

■ Leibniz-Strategiefonds (Leibniz Strategic Fund)

“Leibniz-MMS: Mathematische Modellierung und Simulation” (Leibniz MMS: Mathematical Modeling and Simulation; July 2017 – December 2020, in Director’s office)

Approved Project:

“Leibniz-MMS: Mathematische Modellierung und Simulation” (Leibniz MMS: Mathematical Modeling and Simulation; January 2021 – December 2022, in Director’s office)

■ Leibniz-Wettbewerb (Leibniz Competition)

“Numerische Methoden für innovative Halbleiter-Bauteile” (Numerical Methods for Innovative Semiconductor Devices; January 2020 – December 2024, in LG 5)

Approved Project:

“Probabilistische Methoden für dynamische Kommunikationsnetzwerke” (Probabilistic Methods for Dynamic Communication Networks; January 2021 – December 2025, in LG 6)

Einstein Stiftung Berlin (Einstein Foundation Berlin)

- Thematic Einstein Semester “Energy-Based Mathematical Methods for Reactive Multiphase Flows”

Investitionsbank Berlin

- **Programm zur Förderung von Forschung, Innovationen und Technologien (ProFIT)** (Support program for research, innovation and technology)

“ReLkat – Reinforcement Learning für komplexe automatisierungstechnische Anwendungen” (Reinforcement Learning for complex automation engineering), Fraunhofer IPK, Berlin

The project in collaboration with Signal Cruncher GmbH and Fraunhofer IPK in the realm of Industry 4.0 develops machine-learning algorithms for the efficiency optimization of industrial high-energy production processes. The algorithms have to work on-site with continuous updating of the current state and in real-time environments. Reinforcement Learning methods for high-dimensional nonlinear systems are realized with efficient low-rank tensor formats (in RG 4).

Deutscher Akademischer Austauschdienst (DAAD, German Academic Exchange Service), Bonn

- **Programm “Hochschulkooperationen AIMS in Südafrika, Kamerun und Ghana in 2018–2022”**

“Berlin-AIMS Network in Stochastic Analysis”, started in July 2018, jointly with HU Berlin, in RG 5.

- **Program for Project-Related Personal Exchange (PPP) with India**, “Analysis and numerical methods for population balance equations” (in RG 3)

- Approved Project:

Program for Project-Related Personal Exchange (PPP) with Norway 2021–2022, “Optimal shape design for cardiovascular flows”, jointly with Simula (Oslo) and HU Berlin (in RG 8)

International projects

- Fondation Mathématique Jacques Hadamard (FMJH): Accounting for uncertainty in distribution networks (in RG 4)

**Mission-oriented research (examples)**

- Orange Labs Research, Paris, France:
 - “Connectivity improvements in mobile device-to-device networks” (01.12.2019–30.11.2020; in RG 5),
 - “Malware propagation in mobile device-to-device networks” (01.09.2020–31.08.2020; in RG 5)
- Approved Project:
 - Ferdinand Braun Institute, Berlin:
 - “Simulation of external cavity and multi-section semiconductor lasers” (01.01.2021–31.07.2021; in RG 2)

A.3 Membership in Editorial Boards²

1. J. SPREKELS, Editorial Board, Mathematics and its Applications, Annals of the Academy of Romanian Scientists, Academy of Romanian Scientists, Bucharest.
2. ———, Editorial Board, Applications of Mathematics, Institute of Mathematics, Academy of Sciences of the Czech Republic, Prague.
3. ———, Editorial Board, Advances in Mathematical Sciences and Applications, Gakkōtoshō, Tokyo, Japan.
4. CH. BAYER, Managing Editor, Quantitative Finance, Taylor & Francis Online, London, UK.
5. P. FRIZ, Editor-in-Chief, Annals of Applied Probability, The Institute of Mathematical Statistics, Beachwood, OH, USA.
6. ———, Editorial Board, Electronic Communications in Probability, Institute of Mathematical Statistics, USA.
7. ———, Editorial Board, Electronic Journal of Probability, Institute of Mathematical Statistics, Bethesda, USA.
8. R. HENRION, Editorial Board, Journal of Optimization Theory and Applications, Springer-Verlag, Dordrecht, Netherlands.
9. ———, Editorial Board, Set-Valued and Variational Analysis, Springer-Verlag, Dordrecht, Netherlands.
10. ———, Editorial Board, SIAM Journal on Optimization, Society for Industrial and Applied Mathematics, Philadelphia, Pennsylvania, USA.
11. ———, Editorial Board, Journal of Nonsmooth Analysis and Optimization, Centre pour la Communication Scientifique Directe, Villeurbanne, France.
12. ———, Editorial Board, Optimization — A Journal of Mathematical Programming and Operations Research, Taylor & Francis, Abingdon, UK.
13. M. HINTERMÜLLER, Associate Editor, SIAM Journal on Optimization, Society for Industrial and Applied Mathematics, Philadelphia, USA.
14. ———, Editorial Board, Interfaces and Free Boundaries, European Mathematical Society Publishing House, Zurich, Switzerland.
15. ———, Editorial Board, Annales Mathématiques Blaise Pascal, Laboratoire de Mathématiques CNRS-UMR 6620, Université Blaise Pascal, Clermont-Ferrand, France.
16. ———, Editorial Board, ESAIM: Control, Optimisation and Calculus of Variations, EDP Sciences, Les Ulis, France.
17. ———, Editorial Board, Journal of Nonsmooth Analysis and Optimization, Centre pour la Communication Scientifique Directe, Villeurbanne, France.
18. ———, Editorial Board, Optimization Methods and Software, Taylor & Francis, Oxford, UK.
19. ———, Editorial Board, Foundations of Data Science, American Institute of Mathematical Sciences, Springfield, USA.
20. ———, Series Editor, International Series of Numerical Mathematics, Springer-Verlag, Basel, Switzerland.
21. ———, Series Editor, Handbook of Numerical Analysis, Elsevier, Amsterdam, Netherlands.
22. D. HÖMBERG, Editorial Board, Applicationes Mathematicae, Institute of Mathematics of the Polish Academy of Sciences (IMPAN), Warsaw.

²Memberships in editorial boards by nonresident members have been listed in front of those by the WIAS staff members.

23. ———, Editorial Board, Eurasian Journal of Mathematical and Computer Applications, L.N. Gumilyov Eurasian National University, Astana, Kazakhstan.
24. W. KÖNIG, Advisory Board, Mathematische Nachrichten, WILEY-VCH Verlag, Weinheim.
25. ———, Editorial Board, Bernoulli Journal, International Statistical Institute/Bernoulli Society for Mathematical Statistics and Probability, The Hague, Netherlands.
26. ———, Series Editor, Pathways in Mathematics, Birkhäuser, Basel, Switzerland.
27. A. MIELKE, Editor-in-Chief, GAMM Lecture Notes in Applied Mathematics and Mechanics, Springer-Verlag, Heidelberg.
28. ———, Co-Editor, Zeitschrift für Angewandte Mathematik und Physik (ZAMP), Birkhäuser Verlag, Basel, Switzerland.
29. ———, Editorial Board, Zeitschrift für Angewandte Mathematik und Mechanik (ZAMM), WILEY-VCH Verlag, Weinheim.
30. M. RADZIUNAS, Editorial Board, Mathematical Modelling and Analysis, Vilnius, Lithuania.
31. J.G.M. SCHOENMAKERS, Editorial Board, International Journal of Portfolio Analysis and Management, Interscience Enterprises Limited, Geneva, Switzerland.
32. ———, Editorial Board, Journal of Computational Finance, Incisive Media Investments Limited, London, UK.
33. ———, Editorial Board, Monte Carlo Methods and Applications, Walter de Gruyter, Berlin, New York, USA.
34. V. SPOKOINY, Editor, Theory of Probability and its Applications, SIAM, Philadelphia, Pennsylvania, USA.
35. M. THOMAS, Associate Editor, Discrete & Continuous Dynamical Systems – Series S, American Institute of Mathematical Sciences, Springfield, USA.
36. B. WAGNER, Editorial Board, Journal of Engineering Mathematics, Springer-Verlag, Dordrecht, Netherlands.
37. ———, Editorial Board, SIAM Journal on Applied Mathematics, Society for Industrial and Applied Mathematics, Philadelphia, USA.

A.4 Conferences, Colloquia, and Workshops

INTERNATIONAL WORKSHOP “EFFICIENT ALGORITHMS FOR NUMERICAL PROBLEMS”

Berlin, January 17

Organized by: WIAS (RG 6)

The aim of this one-day workshop was to discuss research ranging from complexity theory of numerical problems, both by using deterministic and Monte Carlo methods, to various aspects of inverse problems. Emphasis was on efficiency of numerical methods within these areas. Embedded as Institute’s Colloquium was the presentation by S. Heinrich on “Quantum computing for numerical problems”.

The Conference was attended by about 30 participants mainly from Germany, as well as from France and Austria.

WORKSHOP ON PDE-CONSTRAINED OPTIMIZATION UNDER UNCERTAINTY AND MEAN FIELD GAMES

Berlin, January 28–30

Organized by: WIAS (RG 4 and RG 8)

Supported by: Fondation Mathématique Jacques Hadamard, TRR 154, WIAS

The aim of the workshop was to gather researchers from the areas of PDE-constrained optimization, stochastic optimization, and mean field games and to provide a forum for discussing topics on the interface between these disciplines. The initiative to organize such a meeting at WIAS arose from joint research interests of RG 4 *Nonlinear Optimization and Inverse Problems* and RG 8 *Nonsmooth Variational Problems and Operator Equations*. 40 scientists from 6 countries participated in the workshop and presented new results on risk averse PDE-constrained optimization using robust optimization, chance constraints, or stochastic gradient methods. Further talks concerned, among others, sampling methods, variational mean field games, or uncertainty quantification.

13TH BERLIN-OXFORD YOUNG RESEARCHERS MEETING ON APPLIED STOCHASTIC ANALYSIS

Berlin, June 8–10

Organized by: WIAS (RG 6), TU Berlin, University of Oxford

Supported by: DataSig, ERC, DFG FOR 2402, DFG IRTG 2544, TU Berlin, University of Oxford, WIAS

Mitigating the situation caused by the Covid-19 pandemic, the workshop was hosted online on the platform Zoom and, with more than 100 registered participants, attracted a bigger audience than ever before. In the spirit of previous meetings, among the participants were many early-career researchers from Berlin and Oxford, but also young researchers from partnering research institutions around the world. This diversity was also reflected among the 37 invited speakers who were affiliated with British, Chinese, French, German, Norwegian, Swiss, and US-American institutions.

The topics covered in the workshop were based on the strong research tradition established in the previous meetings: With rough analysis at its core, insights from powerful pathwise techniques, such as rough paths theory, paracontrolled calculus, and regularity structures were presented centered on (singular, nonlinear) stochastic (partial, rough) differential equations and aspects of their numerical treatment. In addition, the workshop featured several talks on the theoretical applications of signatures as well as practical applications of rough analysis in statistics and deep learning.

The Berlin-Oxford Meeting is a cornerstone of the strategic partnership between the Berlin institutions and the University of Oxford: It reflects a long-nurtured academic and personal relationship while at the same time incorporating new elements such as the recently introduced, DFG-funded International Research Training Group (IRTG) 2544 *Stochastic Analysis in Interaction* between the institutions.

The workshop was jointly organized by Oleg Butkovsky (WIAS), Tom Klohe (TU Berlin), Avi Mayorcas, and Patric Bonnier (both University of Oxford) and chaired by the scientific committee consisting of Peter Friz (WIAS and TU Berlin) as well as Terry Lyons (University of Oxford).

TES STUDENT COMPACT COURSE VARIATIONAL METHODS FOR FLUIDS AND SOLIDS (ONLINE COURSE)

OF THE THEMATIC EINSTEIN SEMESTER ON ENERGY-BASED MATHEMATICAL METHODS FOR REACTIVE MULTIPHASE FLOWS
Berlin, October 12–23

Organized by: WIAS (RG 1 (Matthias Liero, Alexander Mielke), RG 7 (Barbara Wagner), WG 1 (Marita Thomas, Dirk Peschka)), and Volker Mehrmann (TU Berlin)

Supported by: CRC 1114, Einstein Foundation Berlin

The two-week compact course was offered as an online course for undergraduate and graduate students and provided the 109 registered participants from 13 countries with an in-depth look at the topics covered in the Thematic Einstein Semester. These included topics in variational thermomechanics and its applications, modeling by port-Hamiltonian systems and GENERIC, analytical and numerical methods. The course offered four lectures a day (45 minutes each) and time for extensive interactive discussions. Lectures were given in blocks by the organizers of the semester and by the six invited speakers Rupert Klein, Arjan van der Schaft, Michiel Renger, Ansgar Jüngel, Luca Heltai, Elena Celledoni. Seven students took the opportunity to present their own research interests in short talks. TES-related student projects were initiated at the end of the course and carried out during the semester.

TES KICKOFF CONFERENCE (ONLINE-EVENT) OF THE THEMATIC EINSTEIN SEMESTER ON ENERGY-BASED MATHEMATICAL METHODS FOR REACTIVE MULTIPHASE FLOWS

Berlin, October 26–30

Organized by: WIAS (RG 1 (Matthias Liero, Alexander Mielke), RG 7 (Barbara Wagner), WG 1 (Marita Thomas, Dirk Peschka)), and Volker Mehrmann (TU Berlin)

Supported by: CRC 910, Einstein Foundation Berlin

This international, interdisciplinary online-only conference was the scientific start of the Thematic Einstein Semester on Energy-based Mathematical Methods for Reactive Multiphase Flows with the goal to give a platform to identify and discuss the most recent research questions arising in this topic from the different perspectives of applied sciences, thermomechanical modeling, numerics, and mathematical analysis. This aim was achieved with 25 invited presentations held by international experts from different research disciplines and 10 contributed presentations, each given additional time for discussions in virtual break-out rooms, and with two moderated round-table discussions on the topics “Synergies between Thermodynamics and Mathematics” and “Pros and Cons of Energy-Based Modeling Concepts”. The Friday afternoon session was organized in cooperation with the DFG CRC 910 *Control of Self-organizing Nonlinear Systems: Theoretical Methods and Concepts of Application*. The conference attracted 148 registered participants (among them 36 students) from 13 different countries in Europe, Northern America, and Asia.

WORKSHOP ON STOCHASTIC GEOMETRY AND COMMUNICATIONS

Berlin, November 2–4

Organized by: WIAS (RG 5 (Benedikt Jahnel, Wolfgang König))

Supported by: DFG SPP 2265

In the last decades, the theories of point processes, random tessellations, random graphs, and stochastic dynamics have been applied very successfully to problems in many kinds of communication systems. Examples are numerous and range from data propagation, ad-hoc networks to typical communication cells, and much more. The aim of this workshop was to bring together researchers from different subfields of stochastic geometry and related research areas who are interested in applications in communication networks. The scientific program featured two minicourses delivered by eminent European experts and eight research talks given by scientists with expertise ranging from numerical simulations to abstract point-process theory and beyond. Due to the pandemic, the workshop was performed in a hybrid manner: all talks were given electronically, but most of the WIAS participants were present at the institute. In total, there were 15–20 participants for every talk.

The workshop was organized within the activities of the newly founded *Priority Program SPP 2265 (Random Geometric Systems)*.

WORKSHOP ON MATHEMATICAL ANALYSIS FOR MECHANICS

OF THE THEMATIC EINSTEIN SEMESTER ON ENERGY-BASED MATHEMATICAL METHODS FOR REACTIVE MULTIPHASE FLOWS

Berlin, November 23–25

Organized by: WIAS (RG 1 (Matthias Liero, Alexander Mielke), WG 1 (Marita Thomas))

Supported by: Priority Program SPP 2256, Einstein Foundation Berlin

This three-day workshop was jointly organized with the Priority Program SPP 2256 *Variational Methods for Predicting Complex Phenomena in Engineering Structures and Materials* within the Thematic Einstein Semester on *Energy-based Mathematical Methods for Reactive Multiphase Flows*. The workshop's focus was on the

- derivation of effective models in continuum mechanics for problems with multiple scales (stochastic homogenization, dimension reduction, etc.),
- mechanical modeling and mathematical analysis for complex materials (nematic liquid-crystal elastomers, viscoelastic fluids, fracture and damage, shape memory alloys, etc.),
- variational formulations and relaxation methods.

Due to the Corona pandemic, this workshop was organized in an online-only format. Despite the limitations of online talks, this workshop gave the opportunity to discuss and to compare different approaches to the above-mentioned fields via extensive breaks and parallel virtual discussion sessions between talks. Thus, the workshop still provided a platform for the interaction among young and established researchers.

In average, the workshop had about 40 online participants each day. There were 19 talks by invited speakers eight of which were junior scientists.

ECMI WEBINAR “MATH FOR INDUSTRY 4.0 – MODELS, METHODS AND BIG DATA”

Berlin, December 2–3

Organized by: WIAS (RG 4), ECMI, Fraunhofer ITWM Kaiserslautern

Supported by: ECMI, WIAS

The event was a joint activity with the ECMI Special Interest Groups on “Big Data” and “Maths for the Digital Factory”. Its goal was to bring together data scientists, mathematicians, and engineers from academia and industry to discuss recent developments in digital manufacturing. More than 120 participants from Africa, Asia, and Europe came together to discuss topics like digital twins, data-based modeling, topological data analysis in industry, and virtual plants.

A special session was devoted to funding opportunities in the new European framework program Horizon Europe and the future research agenda proposed by the European technology platform Manufuture.

A.4.1 Oberwolfach Workshops co-organized by WIAS

VARIATIONAL METHODS FOR EVOLUTION

Mathematisches Forschungsinstitut Oberwolfach, September 13–19

Organized by: Alexander Mielke (RG 1), Mark Peletier (Eindhoven), Dejan Slepcev (Pittsburgh)

The workshop continued the successful line of meetings (after 2011, 2014, and 2017) on extending variational approaches to evolution systems and bringing together researchers with different backgrounds and perspectives ranging from calculus of variations, partial differential equations, stochastic analysis, to physics and numerical analysis. In addition to “classical” topics such as gradient-flow structures, new directions were discussed such as related, geometric, variational descriptions to evolution in rate-independent systems, kinetic systems (e.g. Boltzmann equation), fluid dynamics, systems of reaction-diffusion equations, as well as equations on discrete graphs. Links to stochastic analysis (e.g. large-deviation principles) and statistical mechanics were highlighted that give rise to a rigorous connection between microscopic, particle-based descriptions of the systems and their macroscopic dissipative structure.

Due to the Corona pandemic, the workshop was organized in a hybrid format with 25 participants present at the Mathematical Research Institute in Oberwolfach and 25 participants taking part online.



Fig. 1: Two of the three organizers (Mark A. Peletier and Alexander Mielke) keeping 1.5m distance

A.5 Membership in Organizing Committees of non-WIAS Meetings³

1. U. BANDELOW, co-organizer, *Workshop "Biomedical Engineering, Light-Matter Interactions"*, Australian National University, Canberra, Australia, February 13–14.
2. ———, co-organizer, *Workshop "Dynamics in Lasers, Photonics and Quantum Light Sources"*, Macquarie University, Sydney, Australia, February 18.
3. P. FARRELL, organizer of the ECMI minisymposium, *The 13th International Conference on Scientific Computing in Electrical Engineering (SCEE 2020)*, Eindhoven University of Technology, Netherlands, February 16–20.
4. P. FRIZ, co-organizer, *Higher Structures Emerging from Renormalisation (Online Event)*, Universität Wien, Erwin Schrödinger International Institute for Mathematics and Physics, Austria, October 12–16.
5. J. FUHRMANN, member of the Organizing Committee, *Finite Volumes for Complex Applications IX – Methods, Theoretical Aspects, Examples – FVCA 9 (Online Event)*, Bergen, Norway, June 15–19.
6. M. HINTERMÜLLER, A. KRÖNER, co-organizers of the Minisymposium "Optimal Control and Design with Non-linear PDE Systems", *2020 Annual Meeting of the Deutsche Mathematiker-Vereinigung (online conference)*, Technische Universität Chemnitz, September 14–17.
7. O. MARQUARDT, co-organizer of the Mini-colloquium "Topology- and Geometry-Controlled Functionalization of Nanostructured Metamaterials", *CMD2020GEFES (Online Event)*, European Physical Society & La Real Sociedad Española de Física, August 31 – September 4.
8. CH. MERDON, organizer of the Minisymposium "Pressure-robust Discretisations for Flow Problems and their Applications", *Conference on Scientific Computing (ALGORITMY 2020) (Online Event)*, Slovak University of Technology, Podbanské, Slovakia, September 10–15.
9. A. MIELKE, co-organizer, *Variational Methods for Evolution*, Mathematisches Forschungszentrum Oberwolfach, September 13–19.
10. H. SI, member of the Program Committee (Vice Chair), *10th International Conference "Numerical Geometry, Grid Generation and Scientific Computing" (NUMGRID 2020) (Online Event)*, Russian Academy of Sciences, Federal Research Center of Information and Control, Moscow, Russian Federation, November 25–27.
11. V. SPOKOINY, co-organizer, *Math of Machine Learning 2020*, Sirius University of Science and Technology, Sochi, Russian Federation, February 19–22.
12. ———, co-organizer, *Meeting in Mathematical Statistics "Robustness and Computational Efficiency of Algorithms in Statistical Learning" (Online Event)*, Centre International de Rencontres Mathématiques (CIRM), Luminy, France, December 14–18.
13. A. ZAFFERI, co-organizer, *CRC1114 Ph.D. Workshop (Online Event)*, Freie Universität Berlin, July 20–24.

³Membership in organizing committees of non-WIAS meetings by nonresident members have been listed in front of those by the WIAS staff members.

A.6 Publications

A.6.1 Monographs

- [1] TH. EITER, *Existence and Spatial Decay of Periodic Navier–Stokes Flows in Exterior Domains*, Logos Verlag Berlin GmbH, 2020, 197 pages. Open Access: <https://www.logos-verlag.de/ebooks/OA/978-3-8325-5108-7.pdf>.
- [2] P. FRIZ, M. HAIRER, *A Course on Rough Paths: With an Introduction to Regularity Structures*, Universitext, Springer International Publishing, Basel, 2020, 346 pages.
- [3] B. JAHNEL, W. KÖNIG, *Probabilistic Methods in Telecommunications*, Compact Textbooks in Mathematics, Birkhäuser Basel, 2020, XI, 200 pages.
- [4] M. KANTNER, *Electrically Driven Quantum Dot Based Single-Photon Sources: Modeling and Simulation*, Springer Theses, Springer, Cham, 2020, XVII, 180 pages.
- [5] W. KÖNIG, *Große Abweichungen, Techniken und Anwendungen*, Mathematik Kompakt, Birkhäuser Basel, 2020, VIII, 167 pages.

A.6.2 Editorship of Proceedings and Collected Editions

- [1] R. KLÖFKORN, E. KEILEGAVLEN, F.A. RADU, J. FUHRMANN, eds., *Finite Volumes for Complex Applications IX – Methods, Theoretical Aspects, Examples – FVCA 9, Bergen, June 2020*, vol. 323 of Springer Proceedings in Mathematics & Statistics, Springer International Publishing, Cham et al., 2020, 775 pages.
- [2] P.Q. KHANH, J.E. MARTINEZ-LEGAZ, CH. TAMMER, R. HENRION, eds., *Special Issue dedicated to the 65th birthday of Alexander Kruger*, vol. 69 of Optimization, no. 12, Taylor & Francis, London, 2020. Open Access: <http://tandfonline.com/doi/full/10.1080/02331934.2020.1815940>.

Proceedings and Collected Editions (to appear)

- [1] A. MIELKE, M. PELETIER, D. SLEPCEV, eds., *Variational Methods for Evolution*, Oberwolfach Reports, European Mathematical Society Publishing House, Zurich.

A.6.3 Outstanding Contributions to Monographs

- [1] V. JOHN, P. KNOBLOCH, U. WILBRANDT, *Chapter 6: Finite Element Pressure Stabilizations for Incompressible Flow Problems*, in: *Fluids under Pressure*, T. Bodnár, G. Galdi, Š. Nečasová, eds., Advances in Mathematical Fluid Mechanics, Birkhäuser, Cham, 2020, pp. 483–573.
- [2] U.W. POHL, A. STRITTMATTER, A. SCHLIWA, M. LEHMANN, T. NIERMANN, T. HEINDEL, ST. REITZENSTEIN, M. KANTNER, U. BANDELOW, TH. KOPRUCKI, H.-J. WÜNSCHE, *Chapter 3: Stressor-Induced Site Control of Quantum Dots for Single-Photon Sources*, in *Semiconductor Nanophotonics*, M. Kneissl, A. Knorr, St. Reitzenstein, A. Hoffmann, eds., vol. 194 of Springer Series in Solid-State Sciences, Springer, Heidelberg, 2020, pp. 53–90.
- [3] S. RODT, P.-I. SCHNEIDER, L. ZSCHIEDRICH, T. HEINDEL, S. BOUNOUAR, M. KANTNER, TH. KOPRUCKI, U. BANDELOW, S. BURGER, ST. REITZENSTEIN, *Chapter 8: Deterministic Quantum Devices for Optical Quantum Communication*, in: *Semiconductor Nanophotonics*, M. Kneissl, A. Knorr, St. Reitzenstein, A. Hoffmann, eds., vol. 194 of Springer Series in Solid-State Sciences, Springer, Heidelberg, 2020, pp. 285–359.

- [4] M. KANTNER, TH. HÖHNE, TH. KOPRUCKI, S. BURGER, H.-J. WÜNSCHE, F. SCHMIDT, A. MIELKE, U. BANDELOW, *Chapter 7: Multi-Dimensional Modeling and Simulation of Semiconductor Nanophotonic Devices*, in: *Semiconductor Nanophotonics*, M. Kneissl, A. Knorr, St. Reitzenstein, A. Hoffmann, eds., vol. 194 of Springer Series in Solid-State Sciences, Springer, Heidelberg, 2020, pp. 241–283.
- [5] R. AHRENS, Z. LAKDAWALA, A. VOIGT, V. WIEDMEYER, V. JOHN, S. LE BORNE, K. SUNDMACHER, *Chapter 14: Numerical Methods for Coupled Population Balance Systems Applied to the Dynamical Simulation of Crystallization Processes*, in: *Dynamic Flowsheet Simulation of Solids Processes*, St. Heinrich, ed., Springer, Cham, 2020, pp. 475–518.

A.6.4 Articles in Refereed Journals⁴

- [1] M. BROKATE, *Newton and Bouligand derivatives of the scalar play and stop operator*, *Math. Model. Nat. Phenom.*, 15 (2020), pp. 51/1–51/34. Open Access: <http://mmnp-journal.org/articles/mmnp/pdf/2020/01/mmnp190061.pdf>.
- [2] P. COLLI, G. GILARDI, J. SPREKELS, *Asymptotic analysis of a tumor growth model with fractional operators*, *Asymptot. Anal.*, 120 (2020), pp. 41–72.
- [3] ———, *Longtime behavior for a generalized Cahn–Hilliard system with fractional operators*, *Atti Accad. Peloritana Pericolanti Cl. Sci. Fis. Mat. Natur.*, 98 (2020), pp. A4/1–A4/18. Open Access: <https://cab.unime.it/journals/index.php/AAPP/article/view/AAPP98S2A4/AAPP98S2A4>.
- [4] CH. KWOFIE, I. AKOTO, K. OPOKU-AMEYAW, *Modelling the dependency between inflation and exchange rate using copula*, *J. Probab. Stat.*, 2020 (2020), pp. 2345746/1–2345746/7. Open Access: <https://www.hindawi.com/journals/jps/2020/2345746/>.
- [5] A. ALPHONSE, M. HINTERMÜLLER, C.N. RAUTENBERG, *Existence, iteration procedures and directional differentiability for parabolic QVIs*, *Calc. Var. Partial Differ. Equ.*, 59 (2020), pp. 95/1–95/53.
- [6] L. ANDREIS, M. FLORA, F. FONTINI, T. VARGIOLU, *Pricing reliability options under different electricity price regimes*, *Energy Econ.*, 87 (2020), pp. 104705/1–104705/25.
- [7] M.J. ARENAS JAÉN, D. HÖMBERG, R. LASARZIK, P. MIKKONEN, TH. PETZOLD, *Modelling and simulation of flame cutting for steel plates with solid phases and melting*, *J. Math. Ind.*, 10 (2020), pp. 18/1–18/16. Open Access: <https://mathematicsinindustry.springeropen.com/articles/10.1186/s13362-020-00086-0>.
- [8] U. BANDELOW, S. AMIRANASHVILI, S. PICKARTZ, *Stabilization of optical pulse transmission by exploiting fiber nonlinearities*, *J. Lightwave Technol.*, 38 (2020), pp. 5743–5747.
- [9] CH. BAYER, CH.B. HAMMOUDA, R. TEMPONE, *Hierarchical adaptive sparse grids and quasi-Monte Carlo for option pricing under the rough Bergomi model*, *Quant. Finance*, published online on 20.04.2020, <https://doi.org/10.1080/14697688.2020.1744700>.
- [10] CH. BAYER, R.F. TEMPONE, S. WOLFERS, *Pricing American options by exercise rate optimization*, *Quant. Finance*, published online on 07.07.2020, <https://doi.org/10.1080/14697688.2020.1750678>.
- [11] CH. BAYER, D. BELOMESTNY, M. REDMANN, S. RIEDEL, J.G.M. SCHOENMAKERS, *Solving linear parabolic rough partial differential equations*, *J. Math. Anal. Appl.*, 490 (2020), pp. 124236/1–124236/45.
- [12] CH. BAYER, M. REDMANN, J.G.M. SCHOENMAKERS, *Dynamic programming for optimal stopping via pseudo-regression*, *Quant. Finance*, published online on 01.09.2020, <https://doi.org/10.1080/14697688.2020.1780299>.

⁴Articles that have been written by nonresident members and scholarship holders during their stay at WIAS have been listed in front of those written by the WIAS staff members.

- [13] L. BLANK, E. MENESES RIOSECO, U. WILBRANDT, A. CAIAZZO, *Modeling, simulation, and optimization of geothermal energy production from hot sedimentary aquifers*, *Comput. Geosci.*, 25 (2021), pp. 67–104 (published online on 02.09.2020). Open Access: <https://doi.org/10.1007/s10596-020-09989-8>.
- [14] O. MELCHERT, C. BRÉE, A. TAJALLI, A. PAPE, R. ARKHIPOV, ST. WILLMS, I. BABUSHKIN, D. SKRYABIN, G. STEINMEYER, U. MORGNER, A. DEMIRCAN, *All-optical supercontinuum switching*, *Nat. Photonics*, 3 (2020), pp. 146/1–146/8. Open Access: <https://www.nature.com/articles/s42005-020-00414-1>.
- [15] S. ATHREYA, O. BUTKOVSKY, L. MYTNIK, *Strong existence and uniqueness for stable stochastic differential equations with distributional drift*, *Ann. Probab.*, 48 (2020), pp. 178–210.
- [16] O. BUTKOVSKY, A. KULIK, M. SCHEUTZOW, *Generalized couplings and ergodic rates for SPDEs and other Markov models*, *Ann. Appl. Probab.*, 30 (2020), pp. 1–39.
- [17] O. BUTKOVSKY, M. SCHEUTZOW, *Couplings via comparison principle and exponential ergodicity of SPDEs in the hypoelliptic setting*, *Comm. Math. Phys.*, 379 (2020), pp. 1001–1034. Open Access: <http://doi.org/10.1007/s00220-020-03834-w>.
- [18] C.K. MACNAMARA, A. CAIAZZO, I. RAMIS-CONDE, M.A.J. CHAPLAIN, *Computational modelling and simulation of cancer growth and migration within a 3D heterogeneous tissue: The effects of fibre and vascular structure*, *J. Comput. Sci.*, 40 (2020), pp. 101067/1–101067/24.
- [19] A. CAIAZZO, R. MAIER, D. PETERSEIM, *Reconstruction of quasi-local numerical effective models from low-resolution measurements*, *J. Sci. Comput.*, 85 (2020), pp. 10/1–10/23. Open Access: <https://link.springer.com/article/10.1007/s10915-020-01304-y>.
- [20] D. JANKE, A. CAIAZZO, N. AHMED, N. ALIA, O. KNOTH, B. MOREAU, U. WILBRANDT, D. WILLINK, TH. AMON, V. JOHN, *On the feasibility of using open source solvers for the simulation of a turbulent air flow in a dairy barn*, *Comput. Electron. Agric.*, 175 (2020), pp. 105546/1–105546/16. Open Access: <http://doi.org/10.1016/j.compag.2020.105546>.
- [21] G. DONG, H. GUO, *Parametric polynomial preserving recovery on manifolds*, *SIAM J. Sci. Comput.*, 42 (2020), pp. A1885–A1912.
- [22] W. DREYER, P.-É. DRUET, P. GAJEWSKI, C. GUHLKE, *Analysis of improved Nernst–Planck–Poisson models of compressible isothermal electrolytes*, *ZAMP Z. Angew. Math. Phys.*, 71 (2020), pp. 119/1–119/68. Open Access: <https://link.springer.com/article/10.1007/s00033-020-01341-5>.
- [23] P.-É. DRUET, *A theory of generalised solutions for ideal gas mixtures with Maxwell–Stefan diffusion*, *Discrete Contin. Dyn. Syst. Ser. S*, (2020), published online in Nov. 2020, <https://doi.org/10.3934/dcdss.2020458>.
- [24] P.-É. DRUET, A. JÜNGEL, *Analysis of cross-diffusion systems for fluid mixtures driven by a pressure gradient*, *SIAM J. Math. Anal.*, 52 (2020), pp. 2179–2197.
- [25] D. DVINSKIKH, S. OMELCHENKO, A. GASNIKOV, A. TYURIN, *Accelerated gradient sliding for minimizing a sum of functions*, *Dokl. Math.*, 101 (2020), pp. 244–246.
- [26] D. DVINSKIKH, A.I. TYURIN, A. GASNIKOV, S.S. OMELCHENKO, *Accelerated and unaccelerated stochastic gradient descent in model generality*, *Math. Notes*, 108 (2020), pp. 511–522.
- [27] P. DVURECHENSKY, E. GORBUNOV, A. GASNIKOV, *An accelerated directional derivative method for smooth stochastic convex optimization*, *European J. Oper. Res.*, 290 (2021), pp. 601–621 (published online on 20.08.2020).
- [28] A. IVANOVA, P. DVURECHENSKY, A. GASNIKOV, *Composite optimization for the resource allocation problem*, *Optim. Methods Softw.*, published online on 12.02.2020, <https://doi.org/10.1080/10556788.2020.1712599>.

- [29] D. KAMZOLOV, P. DVURECHENSKY, A. GASNIKOV, *Universal intermediate gradient method for convex problems with inexact oracle*, Optim. Methods Softw., published online on 17.01.2020, <https://doi.org/10.1080/10556788.2019.1711079>.
- [30] Y. NESTEROV, A. GASNIKOV, S. GUMINOV, P. DVURECHENSKY, *Primal-dual accelerated gradient methods with small-dimensional relaxation oracle*, Optim. Methods Softw., published online on 02.03.2020, <https://doi.org/10.1080/10556788.2020.1731747>.
- [31] M. EIGEL, M. MARSCHALL, M. MULTERER, *An adaptive stochastic Galerkin tensor train discretization for randomly perturbed domains*, SIAM ASA J. Uncertain. Quantif., 8 (2020), pp. 1189–1214.
- [32] M. EIGEL, M. MARSCHALL, M. PFEFFER, R. SCHNEIDER, *Adaptive stochastic Galerkin FEM for lognormal coefficients in hierarchical tensor representations*, Numer. Math., 145 (2020), pp. 655–692. Open Access: <https://link.springer.com/article/10.1007/s00211-020-01123-1>.
- [33] M. EIGEL, R. GRUHLKE, *A local hybrid surrogate-based finite element tearing interconnecting dual-primal method for non-smooth random partial differential equations*, Internat. J. Numer. Methods Engrg., 122 (2021), pp. 1001–1030 (published online in December 2020). Open Access: <https://onlinelibrary.wiley.com/doi/epdf/10.1002/nme.6571>.
- [34] M. DRIESCHNER, M. EIGEL, R. GRUHLKE, D. HÖMBERG, Y. PETRYNA, *Comparison of various uncertainty models with experimental investigations regarding the failure of plates with holes*, Reliab. Eng. Syst. Safety, 203 (2020), pp. 107106/1–107106/12.
- [35] TH. EITER, M. KYED, Y. SHIBATA, *On periodic solutions for one-phase and two-phase problems of the Navier–Stokes equations*, J. Evol. Equ., published online on 06.11.2020. Open Access: <https://link.springer.com/article/10.1007/s00028-020-00619-5>.
- [36] I. FRANOVIĆ, S. YANCHUK, S. EYDAM, I. BAČIĆ, M. WOLFRUM, *Dynamics of a stochastic excitable system with slowly adapting feedback*, Chaos, 30 (2020), pp. 083109/1–083109/11.
- [37] I. SELMER, P. FARRELL, I. SMIRNOVA, P. GURIKOV, *Comparison of finite difference method and finite volume method simulations for a mass transport model describing the supercritical drying kinetic of gel particles in a packed bed*, Gels, 6 (2020), pp. 45/1–45/26. Open Access: <https://doi.org/10.3390/gels6040045>.
- [38] P. COLLI, M.H. FARSHBAF SHAKER, K. SHIRAKAWA, N. YAMAZAKI, *Optimal control for shape memory alloys of the one-dimensional Frémond model*, Numer. Funct. Anal. Optim., 41 (2020), pp. 1421–1471.
- [39] M.H. FARSHBAF SHAKER, M. GUGAT, H. HEITSCH, R. HENRION, *Optimal Neumann boundary control of a vibrating string with uncertain initial data and probabilistic terminal constraints*, SIAM J. Control Optim., 58 (2020), pp. 2288–2311.
- [40] D. FRERICHS, CH. MERDON, *Divergence-preserving reconstructions on polygons and a really pressure-robust virtual element method for the Stokes problem*, IMA J. Numer. Anal., published online on 09.11.2020, <https://doi.org/10.1093/imanum/draa073>.
- [41] I. CHEVYREV, P. FRIZ, A. KOREPANOV, I. MELBOURNE, *Superdiffusive limits for deterministic fast-slow dynamical systems*, Probab. Theory Related Fields, 178 (2020), pp. 735–770. Open Access: <http://link.springer.com/article/10.1007/s00440-020-00988-5>.
- [42] M. COGHI, J.-D. DEUSCHEL, P. FRIZ, M. MAURELLI, *Pathwise McKean–Vlasov theory with additive noise*, Ann. Appl. Probab., 30 (2020), pp. 2355–2392.
- [43] P. FRIZ, T. NILSSEN, W. STANNAT, *Existence, uniqueness and stability of semi-linear rough partial differential equations*, J. Differential Equations, 268 (2020), pp. 1686–1721.
- [44] C. CANCEÈS, C. CHAINAIS-HILLAIRET, J. FUHRMANN, B. GAUDEUL, *A numerical analysis focused comparison of several finite volume schemes for an unipolar degenerated drift-diffusion model*, IMA J. Numer. Anal., 41 (2021), pp. 271–314 (published online on 17.07.2020).

- [45] D.H. DOAN, A. FISCHER, J. FUHRMANN, A. GLITZKY, M. LIERO, *Drift-diffusion simulation of S-shaped current-voltage relations for organic semiconductor devices*, J. Comput. Electron., 19 (2020), pp. 1164–1174. Open Access: <https://link.springer.com/article/10.1007/s10825-020-01505-6>.
- [46] J. FUHRMANN, M. LANDSTORFER, R. MÜLLER, *Modeling polycrystalline electrode-electrolyte interfaces: The differential capacitance*, J. Electrochem. Soc., 167 (2020), pp. 106512/1–106512/15. Open Access: <https://iopscience.iop.org/article/10.1149/1945-7111/ab9cca/pdf>.
- [47] A. ANIKIN, A. GASNIKOV, A. GORNOV, D. KAMZOLOV, Y. MAXIMOV, Y. NESTEROV, *Efficient numerical methods to solve sparse linear equations with application to PageRank*, Optim. Methods Softw., published online on 21.12.2020, <https://doi.org/10.1080/10556788.2020.1858297>.
- [48] M.S. ALKUSA, A. GASNIKOV, D. DVINSKIKH, D.A. KOVALEV, F.S. STONYAKIN, *Accelerated methods for saddle-point problem*, Comput. Math. Math. Phys., 60 (2020), pp. 1787–1809.
- [49] C. GEIERSBACH, W. WOLLNER, *A stochastic gradient method with mesh refinement for PDE-constrained optimization under uncertainty*, SIAM J. Sci. Comput., 42 (2020), pp. A2750–A2772.
- [50] A. GLITZKY, M. LIERO, G. NIKA, *Dimension reduction of thermistor models for large-area organic light-emitting diodes*, Discrete Contin. Dyn. Syst. Ser. S, published online on 28.11.2020. Open Access: <https://www.aims sciences.org/article/doi/10.3934/dcdss.2020460>.
- [51] B. FRANCHI, M. HEIDA, S. LORENZANI, *A mathematical model for Alzheimer's disease: An approach via stochastic homogenization of the Smoluchowski equation*, Comm. Math. Sci., 18 (2020), pp. 1105–1134.
- [52] M. HEIDA, R. KORNHUBER, J. PODLESNY, *Fractal homogenization of a multiscale interface problem*, Multi-scale Model. Simul., 18 (2020), pp. 294–314.
- [53] O. SOUČEK, M. HEIDA, J. MÁLEK, *On a thermodynamic framework for developing boundary conditions for Korteweg-type fluids*, Internat. J. Engrg. Sci., 154 (2020), pp. 103316/1–103316/28.
- [54] D. ADELHÜTTE, D. ASSMANN, T. GONZÁLEZ GRANDÓN, M. GUGAT, H. HEITSCH, R. HENRION, F. LIERS, S. NITSCHKE, R. SCHULTZ, M. STINGL, D. WINTERGERST, *Joint model of probabilistic-robust (probust) constraints with application to gas network optimization*, Vietnam J. Math., published online on 10.11.2020. Open Access: <https://doi.org/10.1007/s10013-020-00434-y>.
- [55] M.J. CÁNOVAS, M.J. GISBERT, R. HENRION, J. PARRA, *Lipschitz lower semicontinuity moduli for linear inequality systems*, J. Math. Anal. Appl., 2 (2020), pp. 124313/1–124313/21.
- [56] T. GONZÁLEZ GRANDÓN, R. HENRION, P. PÉREZ-AROS, *Dynamic probabilistic constraints under continuous random distributions*, Math. Program., published online on 13.11.2020. Open Access: <https://doi.org/10.1007/s10107-020-01593-z>.
- [57] A. HINSEN, B. JAHNEL, E. CALI, J.-P. WARY, *Phase transitions for chase-escape models on Poisson-Gilbert graphs*, Electron. Comm. Probab., 25 (2020), pp. 25/1–25/14. Open Access: https://projecteuclid.org/download/pdfview_1/euclid.ecp/1585188174.
- [58] L. BANZ, M. HINTERMÜLLER, A. SCHRÖDER, *A posteriori error control for distributed elliptic optimal control problems with control constraints discretized by hp-finite elements*, Comput. Math. Appl., 80 (2020), pp. 2433–2450.
- [59] C. RAUTENBERG, M. HINTERMÜLLER, A. ALPHONSE, *Stability of the solution set of quasi-variational inequalities and optimal control*, SIAM J. Control Optim., 58 (2020), pp. 3508–3532.
- [60] M. HINTERMÜLLER, K. PAPAFIGSOROS, C.N. RAUTENBERG, *Variable step mollifiers and applications*, Integral Equations Operator Theory, 92 (2020), pp. 53/1–53/34. Open Access: <https://link.springer.com/article/10.1007/s00020-020-02608-2>.

- [61] J.I. ASPERHEIM, P. DAS, B. GRANDE, D. HÖMBERG, TH. PETZOLD, *Three-dimensional numerical study of heat affected zone in induction welding of tubes*, COMPEL, 39 (2020), pp. 213–219.
- [62] F. AURICCHIO, E. BONETTI, M. CARRATURO, D. HÖMBERG, A. REALI, E. ROCCA, *A phase-field-based graded-material topology optimization with stress constraint*, Math. Models Methods Appl. Sci., 30 (2020), pp. 1461–1483.
- [63] J.A. CARRILLO, K. HOPE, J.L. RODRIGO, *On the singularity formation and relaxation to equilibrium in 1D Fokker–Planck model with superlinear drift*, Adv. Math., 360 (2020), pp. 106883/1–106883/66.
- [64] J.A. CARRILLO, K. HOPE, M.-TH. WOLFRAM, *Numerical study of Bose–Einstein condensation in the Kaniadakis–Quarati model for bosons*, Kinet. Relat. Models, 13 (2020), pp. 507–529.
- [65] CH. HIRSCH, B. JAHNEL, A. TÓBIÁS, *Lower large deviations for geometric functionals*, Electron. Comm. Probab., 25 (2020), pp. 41/1–41/12. Open Access: https://projecteuclid.org/download/pdfview_1/euclid.ecp/1592272819.
- [66] A. TÓBIÁS, B. JAHNEL, *Exponential moments for planar tessellations*, J. Statist. Phys., 179 (2020), pp. 90–109.
- [67] B. GARCÍA-ARCHILLA, V. JOHN, J. NOVO, *Symmetric pressure stabilization for equal-order finite element approximations to the time-dependent Navier–Stokes equations*, IMA J. Numer. Anal., 41 (2021), pp. 1093–1129 (published online on 23.06.2020).
- [68] V. JOHN, P. KNOBLOCH, *Existence of solutions of a finite element flux-corrected-transport scheme*, Appl. Math. Lett., 115 (2021), pp. 106932/1–106932/6 (published online on 01.12.2020).
- [69] V. JOHN, P. KNOBLOCH, P. KORSMEIER, *On the solvability of the nonlinear problems in an algebraically stabilized finite element method for evolutionary transport-dominated equations*, Math. Comp., 90 (2021), pp. 595–611 (published online on 16.11.2020).
- [70] N. AHMED, V. JOHN, *An assessment of two classes of variational multiscale methods for the simulation of incompressible turbulent flows*, Comput. Methods Appl. Mech. Engrg., 365 (2020), pp. 112997/1–112997/20.
- [71] M. KANTNER, *Generalized Scharfetter–Gummel schemes for electro-thermal transport in degenerate semiconductors using the Kelvin formula for the Seebeck coefficient*, J. Comput. Phys., 402 (2020), pp. 109091/1–109091/24.
- [72] M. KANTNER, TH. KOPRUCKI, *Beyond just “flattening the curve”: Optimal control of epidemics with purely non-pharmaceutical interventions*, J. Math. Ind., 10 (2020), pp. 23/1–23/23. Open Access: <https://mathematicsinindustry.springeropen.com/articles/10.1186/s13362-020-00091-3>.
- [73] D. UEBEL, ST. KAYSER, T. MARKURT, O.C. ERNST, TH. TEUBNER, T. BOECK, *Fast Raman mapping and in situ TEM observation of metal induced crystallization of amorphous silicon*, CrystEngComm, 22 (2020), pp. 7983–7991.
- [74] L.G. RAMOS, R. KEHL, R. NABBEN, *Projections, deflation and multigrid for non-symmetric matrices*, SIAM J. Matrix Anal. Appl., 41 (2020), pp. 83–105.
- [75] O. KLEIN, D. DAVINO, C. VISIONE, *On forward and inverse uncertainty quantification for models involving hysteresis operators*, Math. Model. Nat. Phenom., 15 (2020), pp. 53/1–53/19. Open Access: <https://www.mmnp-journal.org/articles/mmnp/abs/2020/01/mmnp180200/mmnp180200.html>.
- [76] S. JANSEN, W. KÖNIG, B. SCHMIDT, F. THEIL, *Surface energy and boundary layers for a chain of atoms at low temperature*, Arch. Ration. Mech. Anal., 239 (2021), pp. 915–980 (published online on 21.12.2020). Open Access: <https://link.springer.com/article/10.1007/s00205-020-01587-3>.

- [77] M.S. ARONNA, J.F. BONNANS, A. KRÖNER, *State-constrained control-affine parabolic problems I: First and second order necessary optimality conditions*, Set-Valued Var. Anal., published online on 17.10.2020, <https://doi.org/10.1007/s11228-020-00560-2>.
- [78] M. LANDSTORFER, B. PRIFLING, V. SCHMIDT, *Mesh generation for periodic 3D microstructure models and computation of effective properties*, J. Comput. Phys., 431 (2021), pp. 110071/1–110071/20 (published online on 23.12.2020).
- [79] TH. FRENZEL, M. LIERO, *Effective diffusion in thin structures via generalized gradient systems and EDP-convergence*, Discrete Contin. Dyn. Syst. Ser. S, 14 (2021), pp. 395–425 (published online in May 2020).
- [80] A. KIRCH, A. FISCHER, M. LIERO, J. FUHRMANN, A. GLITZKY, S. REINEKE, *Experimental proof of Joule heating-induced switched-back regions in OLEDs*, Light Sci. Appl., 9 (2020), pp. 5/1–5/10. Open Access: <https://www.nature.com/articles/s41377-019-0236-9>.
- [81] A. LINKE, CH. MERDON, M. NEILAN, *Pressure-robustness in quasi-optimal a priori estimates for the Stokes problem*, Electron. Trans. Numer. Anal., 52 (2020), pp. 281–294. Open Access: https://epub.oeaw.ac.at/0xc1aa5576_0x003b8d45.pdf.
- [82] M. AKBAS, TH. GALLOUËT, A. GASSMANN, A. LINKE, CH. MERDON, *A gradient-robust well-balanced scheme for the compressible isothermal Stokes problem*, Comput. Methods Appl. Mech. Engrg., 367 (2020), pp. 113069/1–113069/25.
- [83] A. MALTSI, T. NIERMANN, T. STRECKENBACH, K. TABELOW, TH. KOPRUCKI, *Numerical simulation of TEM images for In(Ga)As/GaAs quantum dots with various shapes*, Opt. Quantum Electron., 52 (2020), pp. 257/1–257/11.
- [84] K.M. GAMBARYAN, T. BOECK, A. TRAMPERT, O. MARQUARDT, *Nucleation chronology and electronic properties of In(As,Sb,P) graded composition quantum dots grown on InAs(100) substrate*, ACS Appl. Electron. Mater., 2 (2020), pp. 646–650.
- [85] O. MARQUARDT, M.A. CARO, TH. KOPRUCKI, P. MATHÉ, M. WILLATZEN, *Multiband $k \cdot p$ model and fitting scheme for ab initio-based electronic structure parameters for wurtzite GaAs*, Phys. Rev. B., 101 (2020), pp. 235147/1–235147/12.
- [86] S. LU, P. MATHÉ, S. PEREVERZYEV, *Randomized matrix approximation to enhance regularized projection schemes in inverse problems*, Inverse Problems, 36 (2020), pp. 085013/1–085013/20.
- [87] P. MATHÉ, M.T. NAIR, B. HOFMANN, *Regularization of linear ill-posed problems involving multiplication operators*, Appl. Anal., published online 28.04.2020, <https://doi.org/10.1080/00036811.2020.1758308>.
- [88] A. RASTOGI, G. BLANCHARD, P. MATHÉ, *Convergence analysis of Tikhonov regularization for non-linear statistical inverse problems*, Electron. J. Stat., 14 (2020), pp. 2798–2841. Open Access: <https://doi.org/10.1214/20-EJS1735>.
- [89] A. MIELKE, T. ROUBÍČEK, *Thermoviscoelasticity in Kelvin–Voigt rheology at large strains*, Arch. Ration. Mech. Anal., 238 (2020), pp. 1–45. Open Access: <https://link.springer.com/article/10.1007/s00205-020-01537-z>.
- [90] J. MAAS, A. MIELKE, *Modeling of chemical reaction systems with detailed balance using gradient structures*, J. Statist. Phys., 181 (2020), pp. 2257–2303. Open Access: <https://link.springer.com/content/pdf/10.1007/s10955-020-02663-4.pdf>.
- [91] A. MIELKE, A. STEPHAN, *Coarse-graining via EDP-convergence for linear fast-slow reaction systems*, Math. Models Methods Appl. Sci., 30 (2020), pp. 1765–1807.
- [92] N.A. DAO, J.I. DÍAZ, Q.B.H. NGUYEN, *Pointwise gradient estimates in multi-dimensional slow diffusion equations with a singular quenching term*, Adv. Nonlinear Stud., 20 (2020), pp. 373–384.

- [93] T. ORENSHTEIN, CH. SABOT, *Random walks in random hypergeometric environment*, Electron. J. Probab., 25 (2020), pp. 33/1–33/21. Open Access: <https://projecteuclid.org/euclid.ejp/1583805862>.
- [94] J.-D. DEUSCHEL, T. ORENSHTEIN, *Scaling limit of wetting models in 1+1 dimensions pinned to a shrinking strip*, Stochastic Process. Appl., 130 (2020), pp. 2778–2807.
- [95] A. PIMENOV, S. AMIRANASHVILI, A. VLADIMIROV, *Temporal cavity solitons in a delayed model of a dispersive cavity ring laser*, Math. Model. Nat. Phenom., 15 (2020), pp. 47/1–47/18. Open Access: <https://www.mmnp-journal.org/articles/mmnp/abs/2020/01/mmnp180202/mmnp180202.html>.
- [96] U. GOWDA, A. ROCHE, A. PIMENOV, A.G. VLADIMIROV, S. SLEPNEVA, E.A. VIKTOROV, G. HUYET, *Turbulent coherent structures in a long cavity semiconductor laser near the lasing threshold*, Opt. Lett., 45 (2020), pp. 4903–4906.
- [97] Y.Y. PARK, J. POLZEHL, S. CHATTERJEE, A. BRECHMANN, M. FIECAS, *Semiparametric modeling of time-varying activation and connectivity in task-based fMRI data*, Comput. Statist. Data Anal., 150 (2020), pp. 107006/1–107006/14.
- [98] J. POLZEHL, K. PAPAITSOROS, K. TABELOW, *Patch-wise adaptive weights smoothing in R*, J. Statist. Software, 95 (2020), pp. 1–27. Open Access: <https://www.jstatsoft.org/v095/i06>.
- [99] R. CHILL, H. MEINLSCHMIDT, J. REHBERG, *On the numerical range of second order elliptic operators with mixed boundary conditions in L^p* , J. Evol. Equ., published online on 20.10.2020, <https://link.springer.com/article/10.1007/s00028-020-00642-6>.
- [100] H. MEINLSCHMIDT, CH. MEYER, J. REHBERG, *Regularization for optimal control problems associated to nonlinear evolution equations*, J. Convex Anal., 27 (2020), pp. 443–485.
- [101] D.R.M. RENGER, J. ZIMMER, *Orthogonality of fluxes in general nonlinear reaction networks*, Discrete Contin. Dyn. Syst. Ser. S, 14 (2021), pp. 205–217 (published online on 19.05.2020).
- [102] D. GABRIELLI, D.R.M. RENGER, *Dynamical phase transitions for flows on finite graphs*, J. Statist. Phys., 181 (2020), pp. 2353–2371. Open Access: <https://link.springer.com/article/10.1007%2Fs10955-020-02667-0>.
- [103] D. BELOMESTNY, J.G.M. SCHOENMAKERS, *Optimal stopping of McKean–Vlasov diffusions via regression on particle systems*, SIAM J. Control Optim., 58 (2020), pp. 529–550.
- [104] D. BELOMESTNY, M. KALEDIN, J.G.M. SCHOENMAKERS, *Semitractability of optimal stopping problems via a weighted stochastic mesh algorithm*, Math. Finance, 30 (2020), pp. 1591–1616. Open Access: <https://onlinelibrary.wiley.com/doi/full/10.1111/mafi.12271>.
- [105] D. BELOMESTNY, J.G.M. SCHOENMAKERS, V. SPOKOINY, B. ZHARKYNBAY, *Optimal stopping via reinforced regression*, Comm. Math. Sci., 18 (2020), pp. 109–121.
- [106] J. TANG, P. CUI, B. LI, Z. YAOBIN, H. SI, *Parallel hybrid mesh adaptation by refinement and coarsening*, Graphical Models, 111 (2020), pp. 101084/1–101084/10.
- [107] L.-CH. LIN, Y. CHEN, G. PAN, V. SPOKOINY, *Efficient and positive semidefinite pre-averaging realized covariance estimator*, Statist. Sinica, 31 (2021), pp. 1–22 (published online on 23.11.2020). Open Access: http://www3.stat.sinica.edu.tw/preprint/SS-2017-0489_Preprint.pdf.
- [108] N. PUCHKIN, V. SPOKOINY, *An adaptive multiclass nearest neighbor classifier*, ESAIM Probab. Stat., 24 (2020), pp. 69–99.
- [109] H. NEIDHARDT, A. STEPHAN, V.A. ZAGREBNOV, *Convergence rate estimates for Trotter product approximations of solution operators for non-autonomous Cauchy problems*, Publ. Res. Inst. Math. Sci., 56 (2020), pp. 83–135.

- [110] F. BACHOC, A. SUVORIKOVA, D. GINSBOURGER, J.-M. LOUBES, V. SPOKOINY, *Gaussian processes with multidimensional distribution inputs via optimal transport and Hilbertian embedding*, *Electron. J. Stat.*, 14 (2020), pp. 2742–2772. Open Access: <https://projecteuclid.org/euclid.ejs/1595404878>.
- [111] V. BETZ, H. SCHÄFER, L. TAGGI, *Interacting self-avoiding polygons*, *Ann. Inst. H. Poincaré Probab. Statist.*, 56 (2020), pp. 1321–1335.
- [112] B. LEES, L. TAGGI, *Site monotonicity and uniform positivity for interacting random walks and the spin $O(N)$ model with arbitrary N* , *Comm. Math. Phys.*, 376 (2020), pp. 487–520.
- [113] N. TAPIA, L. ZAMBOTTI, *The geometry of the space of branched rough paths*, *Proc. London Math. Soc.* (3), 121 (2020), pp. 220–251. Open Access: <https://londmathsoc.onlinelibrary.wiley.com/doi/full/10.1112/plms.12311>.
- [114] J. DIEHL, E.-F. KURUSCH, N. TAPIA, *Time-warping invariants of multidimensional time series*, *Acta Appl. Math.*, published online on 14.05.2020. Open Access: <https://doi.org/10.1007/s10440-020-00333-x>.
- [115] M. THOMAS, C. BILGEN, K. WEINBERG, *Analysis and simulations for a phase-field fracture model at finite strains based on modified invariants*, *ZAMM Z. Angew. Math. Mech.*, 100 (2020), pp. e201900288/1–e201900288/51. Open Access: <https://onlinelibrary.wiley.com/doi/epdf/10.1002/zamm.201900288>.
- [116] R. ROSSI, U. STEFANELLI, M. THOMAS, *Rate-independent evolution of sets*, *Discrete Contin. Dyn. Syst. Ser. S*, 14 (2021), pp. 89–119 (published online in March 2020).
- [117] P. VÁGNER, M. PAVELKA, O. ESEN, *Multiscale thermodynamics of charged mixtures*, *Contin. Mech. Thermodyn.*, published online on 25.07.2020. Open Access: <https://doi.org/10.1007/s00161-020-00900-5>.
- [118] A.G. VLADIMIROV, K. PANAJOTOV, M. TLIDI, *Orthogonally polarized frequency combs in a mode-locked VECSEL*, *Opt. Lett.*, 45 (2020), pp. 252–255.
- [119] M. TLIDI, E. BERRÍOS-CARO, D. PINTO-RAMO, A.G. VLADIMIROV, M.G. CLERC, *Interaction between vegetation patches and gaps: A self-organized response to water scarcity*, *Phys. D*, 414 (2020), pp. 132708/1–132708/12.
- [120] A.V. KOVALEV, P.S. DMITRIEV, A.G. VLADIMIROV, A. PIMENOV, G. HUYET, E.A. VIKTOROV, *Bifurcation structure of a swept-source laser*, *Phys. Rev. E*, 101 (2020), pp. 012212/1–012212/5.
- [121] M.G. HENNESSY, A. MÜNCH, B. WAGNER, *Phase separation in swelling and deswelling hydrogels with a free boundary*, *Phys. Rev. E*, 101 (2020), pp. 032501/1–032501/14.
- [122] A. BONI, H.-J. WÜNSCHE, H. WENZEL, P. CRUMP, *Impact of the capture time on the series resistance of quantum-well diode lasers*, *Semicond. Sci. Technol.*, 35 (2020), pp. 085032/1–085032/9. Open Access: <https://iopscience.iop.org/article/10.1088/1361-6641/ab9723/pdf>.
- [123] J.-P. KÖSTER, A. PUTZ, H. WENZEL, H.-J. WÜNSCHE, M. RADZIUNAS, H. STEPHAN, M. WILKENS, A. ZEGHUZI, A. KNIGGE, *Mode competition in broad-ridge-waveguide lasers*, *Semicond. Sci. Technol.*, 36 (2020), pp. 015014/1–015014/12. Open Access: <https://iopscience.iop.org/article/10.1088/1361-6641/abc6e7/pdf>.

Articles in Refereed Journals (to appear)

- [1] P. COLLI, G. GILARDI, J. SPREKELS, *An asymptotic analysis for a generalized Cahn–Hilliard system with fractional operators*, *J. Evol. Equ.*

- [2] J. SPREKELS, F. TRÖLTZSCH, *Sparse optimal control of a phase field system with singular potentials arising in the modeling of tumor growth*, ESAIM Control Optim. Calc. Var.
- [3] D. ABDEL, P. VÁGNER, J. FUHRMANN, P. FARRELL, *Modelling charge transport in perovskite solar cells: Potential-based and limiting ion depletion*, Electrochim. Acta.
- [4] D. DVINSKIKH, A. GASNIKOV, *Decentralized and parallel primal and dual accelerated methods for stochastic convex programming problems*, J. Inverse Ill-Posed Probl.
- [5] P. FRIZ, P. GASSIAT, P. PIGATO, *Precise asymptotics: Robust stochastic volatility models*, Ann. Appl. Probab.
- [6] C. GEIERSBACH, E. LOAYZA ROMERO, K. WELKER, *Stochastic approximation for optimization in shape spaces*, SIAM J. Optim.
- [7] C. GEIERSBACH, T. SCARINCI, *Stochastic proximal gradient methods for nonconvex problems in Hilbert spaces*, Comput. Optim. Appl.
- [8] A. GLITZKY, M. LIERO, G. NIKA, *An existence result for a class of electrothermal drift-diffusion models with Gauss–Fermi statistics for organic semiconductors*, Anal. Appl. (Singap.).
- [9] M. HEIDA, ST. NEUKAMM, M. VARGA, *Stochastic homogenization of Λ -convex gradient flows*, Discrete Contin. Dyn. Syst. Ser. S.
- [10] M. HINTERMÜLLER, S. RÖSEL, *Duality results and regularization schemes for Prandtl–Reuss perfect plasticity*, ESAIM Control Optim. Calc. Var.
- [11] M. HINTERMÜLLER, ST.-M. STENGL, TH.M. SUROWIEC, *Uncertainty quantification in image segmentation using the Ambrosio–Tortorelli approximation of the Mumford–Shah energy*, J. Math. Imaging Vision.
- [12] L. BAÑAS, R. LASARZIK, A. PROHL, *Numerical analysis for nematic electrolytes*, IMA J. Numer. Anal.
- [13] TH. APEL, V. KEMPF, A. LINKE, CH. MERDON, *A nonconforming pressure-robust finite element method for the Stokes equations on anisotropic meshes*, IMA J. Numer. Anal.
- [14] A.M. TER ELST, A. LINKE, J. REHBERG, *On the numerical range of sectorial forms*, Pure Appl. Funct. Anal.
- [15] G. FU, CH. LEHRENFELD, A. LINKE, T. STRECKENBACH, *Locking free and gradient robust $H(\text{div})$ -conforming HDG methods for linear elasticity*, J. Sci. Comput.
- [16] A. MIELKE, A. MONTEFUSCO, M.A. PELETIER, *Exploring families of energy-dissipation landscapes via tilting: Three types of EDP convergence*, Contin. Mech. Thermodyn.
- [17] J.-D. DEUSCHEL, T. ORENSHTEIN, N. PERKOWSKI, *Additive functionals as rough paths*, Ann. Probab.
- [18] W.M. KLESSE, A. RATHSFELD, C. GROSS, E. MALGUTH, O. SKIBITZKI, L. ZEALOUK, *Fast scatterometric measurement of periodic surface structures in plasma-etching processes*, Measurement.
- [19] A. KROSHNIN, V. SPOKOINY, A. SUVORIKOVA, *Statistical inference for Bures–Wasserstein barycenters*, Ann. Appl. Probab.
- [20] L. TAGGI, *Uniformly positive correlations in the dimer model and phase transition in lattice permutations in \mathbb{Z}^d , $d > 2$, via reflection positivity*, Comm. Pure Appl. Math.
- [21] V. BETZ, L. TAGGI, *Scaling limit of ballistic self-avoiding walk interacting with spatial random permutations*, Electron. J. Probab.
- [22] E. CANDELLERO, A. STAUFFER, L. TAGGI, *Abelian oil and water dynamics does not have an absorbing-state phase transition*, Trans. Amer. Math. Soc.
- [23] K. CHOUK, W. VAN ZUIJLEN, *Asymptotics of the eigenvalues of the Anderson Hamiltonian with white noise potential in two dimensions*, Ann. Probab.

A.6.5 Contributions to Collected Editions

- [1] D. ABDEL, P. FARRELL, J. FUHRMANN, *Comparison of Scharfetter–Gummel schemes for (non-)degenerate semiconductor device simulation*, in: Proceedings of the 20th International Conference on Numerical Simulation of Optoelectronic Devices – NUSOD 2020, J. Piprek, K. Hinzer, eds., IEEE Conference Publications Management Group, Piscataway, 2020, pp. 107–108.
- [2] U. BANDELOW, M. RADZIUNAS, A. ZEGHUZI, H.-J. WÜNSCHE, H. WENZEL, *Dynamics in high-power diode lasers*, in: Semiconductor Lasers and Laser Dynamics IX, M. Sciamanna, R. Michalzik, K. Panajotov, S. Höfling, eds., vol. 11356 of Proceedings of SPIE, 2020, pp. 113560W/1–113560W/14.
- [3] D. DVINSKIKH, A. OGALTSOV, A. GASNIKOV, P. DVURECHENSKY, V. SPOKOINY, *On the line-search gradient methods for stochastic optimization*, in: Proceedings of the 21th IFAC World Congress, R. Findeisen, S. Hirche, K. Janschek, M. Mönnigmann, eds., vol. 53 of IFAC PapersOnLine, Elsevier, 2020, pp. 1715–1720.
- [4] P. DVURECHENSKY, A. GASNIKOV, E. NURMINSKI, F. STONYAKIN, *Advances in low-memory subgradient optimization*, in: Numerical Nonsmooth Optimization, A.M. Bagirov, M. Gaudioso, N. Karmitza, M.M. Mäkelä, S. Taheri, eds., Springer International Publishing, Cham, 2020, pp. 19–59.
- [5] P. DVURECHENSKY, A. GASNIKOV, S. OMELCHENKO, A. TIURIN, *A stable alternative to Sinkhorn’s algorithm for regularized optimal transport*, in: Mathematical Optimization Theory and Operations Research. MOTOR 2020, A. Kononov, M. Khachay, V.A. Kalyagin, P. Pardalos, eds., no. 12095 in Lecture Notes in Computer Science, Springer, Cham, 2020, pp. 406–423.
- [6] P. DVURECHENSKY, P. OSTROUKHOV, K. SAFIN, S. SHTERN, M. STAUDIGL, *Self-concordant analysis of Frank–Wolfe algorithms*, in: Proceedings of the 37th International Conference on Machine Learning, H. Daumé III, A. Singh, eds., vol. 119 of Proceedings of Machine Learning Research (online), 2020, pp. 2814–2824. URL: <http://proceedings.mlr.press/v119/dvurechensky20a.html>.
- [7] N. TUPITSA, A. GASNIKOV, P. DVURECHENSKY, S. GUMINOV, *Strongly convex optimization for the dual formulation of optimal transport*, in: Mathematical Optimization Theory and Operations Research, A. Kononov, M. Khachay, V.A. Kalyagin, P. Pardalos, eds., vol. 1275 of Theoretical Computer Science and General Issues, Springer International Publishing AG, Cham, 2020, pp. 192–204.
- [8] N. TUPITSA, P. DVURECHENSKY, A. GASNIKOV, C.A. URIBE, *Multimarginal optimal transport by accelerated alternating minimization*, in: 2020 59th IEEE Conference on Decision and Control (CDC), IEEE, 2020, pp. 6132–6137.
- [9] V. DVURECHENSKY, *Data-driven confidence bands for distributed nonparametric regression*, in: Proceedings of Thirty Third Conference on Learning Theory, J. Abernethy, S. Agarwal, eds., vol. 125 of Proceedings of Machine Learning Research, PMLR, 2020, pp. 300–322.
- [10] C. CANCÈS, C. CHAINAIS-HILLAIRET, J. FUHRMANN, B. GAUDEUL, *On four numerical schemes for a unipolar degenerate drift-diffusion model*, in: Finite Volumes for Complex Applications IX – Methods, Theoretical Aspects, Examples – FVCA 9, Bergen, June 2020, R. Klöforn, F. Radu, E. Keijgavlen, J. Fuhrmann, eds., Springer Proceedings in Mathematics & Statistics, Springer International Publishing, Cham et al., 2020, pp. 163–171.
- [11] J. FUHRMANN, D.H. DOAN, A. GLITZKY, M. LIERO, G. NIKA, *Unipolar drift-diffusion simulation of S-shaped current-voltage relations for organic semiconductor devices*, in: Finite Volumes for Complex Applications IX – Methods, Theoretical Aspects, Examples – FVCA 9, Bergen, June 2020, R. Klöforn, E. Keilegavlen, F.A. Radu, J. Fuhrmann, eds., vol. 323 of Springer Proceedings in Mathematics & Statistics, Springer International Publishing, Cham et al., 2020, pp. 625–633.
- [12] A. HINSEN, B. JAHNEL, E. CALI, J.-P. WARY, *Malware propagation in urban D2D networks*, in: IEEE 18th International Symposium on on Modeling and Optimization in Mobile, ad Hoc, and Wireless Networks, (WiOpt), Volos, Greece, Institute of Electrical and Electronics Engineers (IEEE), 2020, pp. 1–9.

- [13] A. HINSEN, CH. HIRSCH, B. JAHNEL, E. CALI, *Typical Voronoi cells for Cox point processes on Manhattan grids*, in: 2019 International Symposium on Modeling and Optimization in Mobile, ad Hoc, and Wireless Networks (WiOPT), Avignon, France, 2019, Institute of Electrical and Electronics Engineers (IEEE), 2020, pp. 1–6.
- [14] A. JHA, V. JOHN, *On basic iteration schemes for nonlinear AFC discretizations*, in: Boundary and Interior Layers, Computational and Asymptotic Methods, BAIL 2018, G.N. Barrenechea, J. Mackenzie, eds., vol. 135 of Lecture Notes in Computational Science and Engineering, Springer, Cham, 2020, pp. 113–128.
- [15] M. KANTNER, TH. KOPRUCKI, *Non-isothermal Scharfetter–Gummel scheme for electro-thermal transport simulation in degenerate semiconductors*, in: Finite Volumes for Complex Applications IX – Methods, Theoretical Aspects, Examples – FVCA 9, Bergen, June 2020, R. Klöforn, E. Keilegavlen, F.A. Radu, J. Fuhrmann, eds., vol. 323 of Springer Proceedings in Mathematics & Statistics, Springer International Publishing, Cham et al., 2020, pp. 173–182.
- [16] A. LINKE, CH. MERDON, *On the significance of pressure-robustness for the space discretization of incompressible high Reynolds number flows*, in: Finite Volumes for Complex Applications IX – Methods, Theoretical Aspects, Examples – FVCA 9, Bergen, June 2020, R. Klöforn, E. Keilegavlen, A. Radu, J. Fuhrmann, eds., vol. 323 of Springer Proceedings in Mathematics & Statistics, Springer International Publishing, Cham et al., 2020, pp. 103–112.
- [17] ———, *Well-balanced discretisation for the compressible Stokes problem by gradient-robustness*, in: Finite Volumes for Complex Applications IX – Methods, Theoretical Aspects, Examples – FVCA 9, Bergen, June 2020, R. Klöforn, E. Keilegavlen, A. Radu, J. Fuhrmann, eds., vol. 323 of Springer Proceedings in Mathematics & Statistics, Springer International Publishing, Cham et al., 2020, pp. 113–121.
- [18] U. GOWDA, A. ROCHE, S. SLEPNEVA, A. PIMENOV, E.A. VIKTOROV, A.G. VLADIMIROV, G. HUYET, *Stability of a long cavity laser*, in: Real-time Measurements, Rogue Phenomena, and Single-Shot Applications V, D.R. Solli, G. Herink, S. Bielawski, eds., vol. 11265 of Proceedings of SPIE, SPIE Digital Library, 2020, pp. 112650F/1–112650F/6.
- [19] A. ROCHE, U. GOWDA, A. PIMENOV, A.V. KOVALEV, M. MARCONI, M. GIUDICI, E.A. VIKTOROV, A.G. VLADIMIROV, G. HUYET, S. SLEPNEVA, *Turn on transient in a long cavity laser*, in: Physics and Simulation of Optoelectronic Devices XXVII, B. Witzigmann, M. Osiański, Y. Arakawa, eds., vol. 11274 of Proceedings of SPIE, SPIE Digital Library, 2020, pp. 112740L/1–112740L/6.
- [20] M. KOLARCZIK, F. BÖHM, U. WOGGON, N. OWSCHIMIKOW, A. PIMENOV, M. WOLFRUM, A.G. VLADIMIROV, ST. MEINECKE, B. LINGNAU, L. JAURIGUE, K. LÜDGE, *Coherent and incoherent dynamics in quantum dots and nanophotonic devices*, in: Semiconductor Nanophotonics, M. Kneissl, A. Knorr, St. Reitzenstein, A. Hoffmann, eds., vol. 194 of Springer Series in Solid-State Sciences, Springer, Cham, 2020, pp. 91–133.
- [21] G. GARRE-WERNER, J.J. MONTIEL-PONSODA, V. RAAB, G. SAFONT, C. BRÉE, M. RADZIUNAS, C. COJOCARU, K. STALIUNAS, *1 kW cw fiber-coupled diode laser with enhanced brightness*, in: High-Power Diode Laser Technology XVIII, M.S. Zediker, ed., vol. 11262 of Proceedings of SPIE, SPIE, San Francisco, 2020, pp. 1126202/1–1126202/9.
- [22] M. RADZIUNAS, D.M. KANE, *Semiconductor laser with delayed optical feedback – What simulations tell us that we didn't know*, in: 14th Pacific Rim Conference on Lasers and Electro-Optics (CLEO PR 2020), OSA Technical Digest, Optical Society of America, Washington, 2020, pp. C4C_4/1–C4C_4/2.
- [23] J.-P. KÖSTER, M. RADZIUNAS, A. ZEGHUZI, H. WENZEL, A. KNIGGE, *Traveling wave model-based analysis of tapered broad-area lasers*, in: Physics and Simulation of Optoelectronic Devices XXVIII, B. Witzigmann, M. Osiański, Y. Arakawa, eds., vol. 11274 of Proceedings of SPIE, SPIE, San Francisco, 2020, pp. 112740I/1–112740I/10.
- [24] M. RADZIUNAS, J. MONTIEL-PONSODA, G. GARRE-WERNER, V. RAAB, *Simulation of cascaded polarization-coupled systems of broad-area semiconductor lasers*, in: Proceedings of the 20th International Conference on Numerical Simulation of Optoelectronic Devices – NUSOD 2020, J. Piprek, K. Hinzer, eds., IEEE Conference Publications Management Group, Piscataway, 2020, pp. 97–98.

- [25] ST. SCHULZ, D. CHAUDHURI, M. O'DONOVAN, S. PATRA, T. STRECKENBACH, P. FARRELL, O. MARQUARDT, TH. KOPRUCKI, *Multi-scale modeling of electronic, optical, and transport properties of III-N alloys and heterostructures*, in: Physics and Simulation of Optoelectronic Devices XXVIII, B. Witzigmann, M. Osiński, Y. Arakawa, eds., vol. 11274 of Proceedings of SPIE, San Francisco, 2020, pp. 1127416/1–1127416/10.

Contributions to Collected Editions (to appear)

- [1] D. KAMZOLOV, A. GASNIKOV, P. DVURECHENSKY, *On the optimal combination of tensor optimization methods*, in: Optimization and Applications 2020, Lecture Notes in Computer Science, Springer International Publishing, Basel.
- [2] A. ROGOZIN, V. LUKOSHIN, A. GASNIKOV, D. KOVALEV, E. SHULGIN, *Towards accelerated rates for distributed optimization over time-varying networks*, in: The 24th International Conference on Artificial Intelligence and Statistics (AISTATS 2021).
- [3] K. HOPF, *Global existence analysis of energy-reaction-diffusion systems*, in: Variational Methods for Evolution, Workshop, Sept. 13–19, 2020, A. Mielke, M. Peletier, D. Slepcev, eds., Oberwolfach Reports, European Mathematical Society Publishing House, Zurich.
- [4] F. DEN HOLLANDER, W. KÖNIG, R. SOARES DOS SANTOS, *The parabolic Anderson model on a Galton–Watson tree*, in: In and Out of Equilibrium 3: Celebrating Vladas Sidoravicius, M.E. Vares, R. Fernandez, L.R. Fontes, C.M. Newman, eds., Progress in Probability, Birkhäuser.
- [5] A. STEPHAN, *EDP-convergence for nonlinear fast-slow reaction systems*, in: Variational Methods for Evolution, Workshop, Sept. 13–19, 2020, A. Mielke, M. Peletier, D. Slepcev, eds., Oberwolfach Reports, European Mathematical Society Publishing House, Zurich.

A.7 Preprints, Reports

A.7.1 WIAS Preprints Series⁵

- [1] P. COLLI, G. GILARDI, J. SPREKELS, *An asymptotic analysis for a generalized Cahn–Hilliard system with fractional operators*, Preprint no. 2741, WIAS, Berlin, 2020.
- [2] ———, *Optimal control of a phase field system of Caginalp type with fractional operators*, Preprint no. 2725, WIAS, Berlin, 2020.
- [3] P. COLLI, A. SIGNORI, J. SPREKELS, *Second-order analysis of an optimal control problem in a phase field tumor growth model with singular potentials and chemotaxis*, Preprint no. 2770, WIAS, Berlin, 2020.
- [4] J. SPREKELS, F. TRÖLTZSCH, *Sparse optimal control of a phase field system with singular potentials arising in the modeling of tumor growth*, Preprint no. 2721, WIAS, Berlin, 2020.
- [5] D. ABDEL, P. FARRELL, J. FUHRMANN, *Assessing the quality of the excess chemical potential flux scheme for degenerate semiconductor device simulation*, Preprint no. 2787, WIAS, Berlin, 2020.
- [6] D. ABDEL, P. VÁGNER, J. FUHRMANN, P. FARRELL, *Modelling charge transport in perovskite solar cells: Potential-based and limiting ion depletion*, Preprint no. 2780, WIAS, Berlin, 2020.
- [7] A. ALPHONSE, C.N. RAUTENBERG, J.F. RODRIGUES, *Analysis of a quasi-variational contact problem arising in thermoelasticity*, Preprint no. 2747, WIAS, Berlin, 2020.
- [8] A. ALPHONSE, M. HINTERMÜLLER, C.N. RAUTENBERG, *On the differentiability of the minimal and maximal solution maps of elliptic quasi-variational inequalities*, Preprint no. 2758, WIAS, Berlin, 2020.
- [9] ———, *Optimal control and directional differentiability for elliptic quasi-variational inequalities*, Preprint no. 2756, WIAS, Berlin, 2020.
- [10] S. AMIRANASHVILI, M. RADZIUNAS, U. BANDELOW, K. BUSCH, R. ČIEGIS, *Additive splitting methods for parallel solution of evolution problems*, Preprint no. 2767, WIAS, Berlin, 2020.
- [11] V. AVANESOV, *Data-driven confidence bands for distributed nonparametric regression*, Preprint no. 2729, WIAS, Berlin, 2020.
- [12] ———, *How to gamble with non-stationary X-armed bandits and have no regrets*, Preprint no. 2686, WIAS, Berlin, 2020.
- [13] ———, *Nonparametric change point detection in regression*, Preprint no. 2687, WIAS, Berlin, 2020.
- [14] U. BANDELOW, M. RADZIUNAS, A. ZEGHUZI, H.-J. WÜNSCHE, H. WENZEL, *Dynamics in high-power diode lasers*, Preprint no. 2715, WIAS, Berlin, 2020.
- [15] CH. BAYER, F. HARANG, P. PIGATO, *Log-modulated rough stochastic volatility models*, Preprint no. 2752, WIAS, Berlin, 2020.
- [16] CH. BAYER, J. QIU, Y. YAO, *Pricing options under rough volatility with backward SPDEs*, Preprint no. 2745, WIAS, Berlin, 2020.
- [17] M. REDMANN, CH. BAYER, P. GOYA, *Low-dimensional approximations of high-dimensional asset price models*, Preprint no. 2706, WIAS, Berlin, 2020.
- [18] CH. BAYER, P. FRIZ, N. TAPIA, *Stability of deep neural networks via discrete rough paths*, Preprint no. 2732, WIAS, Berlin, 2020.
- [19] CH. BAYER, D. BELOMESTNY, P. HAGER, P. PIGATO, J.G.M. SCHOENMAKERS, *Randomized optimal stopping algorithms and their convergence analysis*, Preprint no. 2697, WIAS, Berlin, 2020.

⁵Preprints that have been written by nonresident members and scholarship holders during their stay at WIAS have been listed in front of those written by the WIAS staff members.

- [20] CH. BAYER, P. HAGER, S. RIEDEL, J.G.M. SCHOENMAKERS, *Optimal stopping with signatures*, Preprint no. 2790, WIAS, Berlin, 2020.
- [21] CH. BAYER, D. BELOMESTNY, P. HAGER, P. PIGATO, J.G.M. SCHOENMAKERS, V. SPOKOINY, *Reinforced optimal control*, Preprint no. 2792, WIAS, Berlin, 2020.
- [22] F. BESOLD, V. SPOKOINY, *Adaptive manifold clustering*, Preprint no. 2800, WIAS, Berlin, 2020.
- [23] G. DONG, M. HINTERMÜLLER, K. PAPAITSOROS, *Optimization with learning-informed differential equation constraints and its applications*, Preprint no. 2754, WIAS, Berlin, 2020.
- [24] P.-É. DRUET, *A theory of generalised solutions for ideal gas mixtures with Maxwell–Stefan diffusion*, Preprint no. 2700, WIAS, Berlin, 2020.
- [25] D. BOTHE, P.-É. DRUET, *On the structure of continuum thermodynamical diffusion fluxes – A novel closure scheme and its relation to the Maxwell–Stefan and the Fick–Onsager approach*, Preprint no. 2749, WIAS, Berlin, 2020.
- [26] ———, *Well-posedness analysis of multicomponent incompressible flow models*, Preprint no. 2720, WIAS, Berlin, 2020.
- [27] E. GORBUNOV, D. DVINSKIKH, A. GASNIKOV, *Optimal decentralized distributed algorithms for stochastic convex optimization*, Preprint no. 2691, WIAS, Berlin, 2020.
- [28] D. DVINSKIKH, E. GORBUNOV, A. GASNIKOV, A. DVURECHENSKY, C.A. URIBE, *On primal and dual approaches for distributed stochastic convex optimization over networks*, Preprint no. 2690, WIAS, Berlin, 2020.
- [29] F. STONYAKIN, D. DVINSKIKH, P. DVURECHENSKY, A. KROSHNIN, O. KUZNETSOVA, A. AGAFONOV, A. GASNIKOV, A. TYURIN, C.A. URIBE, D. PASECHNYUK, S. ARTAMONOV, *Gradient methods for problems with inexact model of the objective*, Preprint no. 2688, WIAS, Berlin, 2020.
- [30] P. DVURECHENSKY, A. GASNIKOV, E. NURMINSKI, F. STONYAKIN, *Advances in low-memory subgradient optimization*, Preprint no. 2676, WIAS, Berlin, 2020.
- [31] P. DVURECHENSKY, A. GASNIKOV, P. OSTROUKHOV, A.C. URIBE, A. IVANOVA, *Near-optimal tensor methods for minimizing gradient norm*, Preprint no. 2694, WIAS, Berlin, 2020.
- [32] S. GUMINOV, P. DVURECHENSKY, A. GASNIKOV, *On accelerated alternating minimization*, Preprint no. 2695, WIAS, Berlin, 2020.
- [33] P. DVURECHENSKY, M. STAUDIGL, C.A. URIBE, *Generalized self-concordant Hessian-barrier algorithms*, Preprint no. 2693, WIAS, Berlin, 2020.
- [34] N. TUPITSA, P. DVURECHENSKY, A. GASNIKOV, S. GUMINOV, *Alternating minimization methods for strongly convex optimization*, Preprint no. 2692, WIAS, Berlin, 2020.
- [35] A. IVANOVA, A. GASNIKOV, P. DVURECHENSKY, D. DVINSKIKH, A. TYURIN, E. VORONTOVA, D. PASECHNYUK, *Oracle complexity separation in convex optimization*, Preprint no. 2711, WIAS, Berlin, 2020.
- [36] F. STONYAKIN, A. GASNIKOV, A. TYURIN, D. PASECHNYUK, A. AGAFONOV, P. DVURECHENSKY, D. DVINSKIKH, S. ARTAMONOV, V. PISKUNOVA, *Inexact relative smoothness and strong convexity for optimization and variational inequalities by inexact model*, Preprint no. 2709, WIAS, Berlin, 2020.
- [37] F. STONYAKIN, A. GASNIKOV, A. TYURIN, D. PASECHNYUK, A. AGAFONOV, P. DVURECHENSKY, D. DVINSKIKH, V. PISKUNOVA, *Inexact model: A framework for optimization and variational inequalities*, Preprint no. 2679, WIAS, Berlin, 2020.
- [38] D. KAMZOLOV, A. GASNIKOV, P. DVURECHENSKY, *On the optimal combination of tensor optimization methods*, Preprint no. 2710, WIAS, Berlin, 2020.
- [39] R. KRAWCHENKO, C.A. URIBE, A. GASNIKOV, P. DVURECHENSKY, *Distributed optimization with quantization for computing Wasserstein barycenters*, Preprint no. 2782, WIAS, Berlin, 2020.

- [40] M. EIGEL, O. ERNST, B. SPRUNGK, L. TAMELLINI, *On the convergence of adaptive stochastic collocation for elliptic partial differential equations with affine diffusion*, Preprint no. 2753, WIAS, Berlin, 2020.
- [41] M. EIGEL, P. TRUNSCHKE, R. SCHNEIDER, *Convergence bounds for empirical nonlinear least-squares*, Preprint no. 2714, WIAS, Berlin, 2020.
- [42] TH. EITER, *On the spatially asymptotic structure of time-periodic solutions to the Navier–Stokes equations*, Preprint no. 2727, WIAS, Berlin, 2020.
- [43] TH. EITER, G.P. GALDI, *Spatial decay of the vorticity field of time-periodic viscous flow past a body*, Preprint no. 2791, WIAS, Berlin, 2020.
- [44] I. FRANOVIĆ, S. YANCHUK, S. EYDAM, I. BAČIĆ, M. WOLFRUM, *Dynamics of a stochastic excitable system with slowly adapting feedback*, Preprint no. 2678, WIAS, Berlin, 2020.
- [45] P. FARRELL, ST. KAYSER, N. ROTUNDO, *Modeling and simulation of the lateral photovoltage scanning method*, Preprint no. 2784, WIAS, Berlin, 2020.
- [46] P. COLLI, M.H. FARSHBAF SHAKER, K. SHIRAKAWA, N. YAMAZAKI, *Optimal control for shape memory alloys of the one-dimensional Frémond model*, Preprint no. 2737, WIAS, Berlin, 2020.
- [47] M.H. FARSHBAF SHAKER, M. THOMAS, *Analysis of a compressible Stokes-flow with degenerating and singular viscosity*, Preprint no. 2786, WIAS, Berlin, 2020.
- [48] D. FRERICHS, V. JOHN, *On reducing spurious oscillations in discontinuous Galerkin (DG) methods for steady-state convection-diffusion-reaction equations*, Preprint no. 2769, WIAS, Berlin, 2020.
- [49] D. FRERICHS, CH. MERDON, *Divergence-preserving reconstructions on polygons and a really pressure-robust virtual element method for the Stokes problem*, Preprint no. 2683, WIAS, Berlin, 2020.
- [50] C. BELLINGER, A. DJURDJEVAC, P. FRIZ, N. TAPIA, *Transport and continuity equations with (very) rough noise*, Preprint no. 2696, WIAS, Berlin, 2020.
- [51] C. GEIERSBACH, W. WOLLNER, *Optimality conditions for convex stochastic optimization problems in Banach spaces with almost sure state constraint*, Preprint no. 2755, WIAS, Berlin, 2020.
- [52] A. GLITZKY, M. LIERO, G. NIKA, *Dimension reduction of thermistor models for large-area organic light-emitting diodes*, Preprint no. 2719, WIAS, Berlin, 2020.
- [53] ———, *An effective bulk-surface thermistor model for large-area organic light-emitting diodes*, Preprint no. 2757, WIAS, Berlin, 2020.
- [54] M. HEIDA, *Stochastic homogenization on randomly perforated domains*, Preprint no. 2742, WIAS, Berlin, 2020.
- [55] M. HEIDA, M. KANTNER, A. STEPHAN, *Consistency and convergence for a family of finite volume discretizations of the Fokker–Planck operator*, Preprint no. 2684, WIAS, Berlin, 2020.
- [56] H. HEITSCH, R. HENRION, *An enumerative formula for the spherical cap discrepancy*, Preprint no. 2744, WIAS, Berlin, 2020.
- [57] T. GONZÁLEZ GRANDÓN, R. HENRION, P. PÉREZ-AROS, *Dynamic probabilistic constraints under continuous random distributions*, Preprint no. 2783, WIAS, Berlin, 2020.
- [58] A. HINSEN, B. JAHNEL, E. CALI, J.-P. WARY, *Malware propagation in urban D2D networks*, Preprint no. 2674, WIAS, Berlin, 2020.
- [59] M. HINTERMÜLLER, K. PAPAFIGOROS, C.N. RAUTENBERG, H. SUN, *Dualization and automatic distributed parameter selection of total generalized variation via bilevel optimization*, Preprint no. 2689, WIAS, Berlin, 2020.
- [60] M. HINTERMÜLLER, ST.-M. STENGL, *On the convexity of optimal control problems involving non-linear PDEs or VIs and applications to Nash games*, Preprint no. 2759, WIAS, Berlin, 2020.

- [61] [M. HINTERMÜLLER](#), [ST.-M. STENGL](#), [TH.M. SUROWIEC](#), *Uncertainty quantification in image segmentation using the Ambrosio–Tortorelli approximation of the Mumford–Shah energy*, Preprint no. 2703, WIAS, Berlin, 2020.
- [62] [B. JAHNEL](#), [A. TÓBIÁS](#), *Absence of percolation in graphs based on stationary point processes with degrees bounded by two*, Preprint no. 2774, WIAS, Berlin, 2020.
- [63] [B. JAHNEL](#), [A. TÓBIÁS](#), [E. CALI](#), *Phase transitions for the Boolean model of continuum percolation for Cox point processes*, Preprint no. 2704, WIAS, Berlin, 2020.
- [64] [V. JOHN](#), [P. KNOBLOCH](#), *Existence of solutions of a finite element flux-corrected-transport scheme*, Preprint no. 2761, WIAS, Berlin, 2020.
- [65] [N. AHMED](#), [V. JOHN](#), *An assessment of two classes of variational multiscale methods for the simulation of incompressible turbulent flows*, Preprint no. 2698, WIAS, Berlin, 2020.
- [66] [M. KANTNER](#), [TH. KOPRUCKI](#), *Beyond just “flattening the curve”: Optimal control of epidemics with purely non-pharmaceutical interventions*, Preprint no. 2748, WIAS, Berlin, 2020.
- [67] [O.C. ERNST](#), [D. UEBEL](#), [ST. KAYSER](#), [F. LANGE](#), [TH. TEUBNER](#), [T. BOECK](#), *Revealing all states of dewetting of a thin gold layer on a silicon surface by nanosecond laser conditioning*, Preprint no. 2777, WIAS, Berlin, 2020.
- [68] [D. UEBEL](#), [ST. KAYSER](#), [T. MARKURT](#), [O.C. ERNST](#), [TH. TEUBNER](#), [T. BOECK](#), *Fast Raman mapping and in situ TEM observation of metal induced crystallization of amorphous silicon*, Preprint no. 2772, WIAS, Berlin, 2020.
- [69] [ST. KAYSER](#), [P. FARRELL](#), [N. ROTUNDO](#), *Detecting striations via the lateral photovoltage scanning method without screening effect*, Preprint no. 2785, WIAS, Berlin, 2020.
- [70] [W. KÖNIG](#), *Branching random walks in random environment: A survey*, Preprint no. 2779, WIAS, Berlin, 2020.
- [71] [F. DEN HOLLANDER](#), [W. KÖNIG](#), [R. SOARES DOS SANTOS](#), *The parabolic Anderson model on a Galton–Watson tree*, Preprint no. 2675, WIAS, Berlin, 2020.
- [72] [S. JANSEN](#), [W. KÖNIG](#), [B. SCHMIDT](#), [F. THEIL](#), *Distribution of cracks in a chain of atoms at low temperature*, Preprint no. 2789, WIAS, Berlin, 2020.
- [73] [W. KÖNIG](#), [N. PERKOWSKI](#), [W. VAN ZUIJLEN](#), *Longtime asymptotics of the two-dimensional parabolic Anderson model with white-noise potential*, Preprint no. 2765, WIAS, Berlin, 2020.
- [74] [TH. KOPRUCKI](#), [A. MALTSI](#), [A. MIELKE](#), *On the Darwin–Howie–Whelan equations for the scattering of fast electrons described by the Schrödinger equation*, Preprint no. 2801, WIAS, Berlin, 2020.
- [75] [M.S. ARONNA](#), [J.F. BONNANS](#), [A. KRÖNER](#), *State-constrained control-affine parabolic problems I: First and second order necessary optimality conditions*, Preprint no. 2762, WIAS, Berlin, 2020.
- [76] ———, *State-constrained control-affine parabolic problems II: Second order sufficient optimality conditions*, Preprint no. 2778, WIAS, Berlin, 2020.
- [77] [M. LANDSTORFER](#), [B. PRIFLING](#), [V. SCHMIDT](#), *Mesh generation for periodic 3D microstructure models and computation of effective properties*, Preprint no. 2738, WIAS, Berlin, 2020.
- [78] [R. LASARZIK](#), *Analysis of a thermodynamically consistent Navier–Stokes–Cahn–Hilliard model*, Preprint no. 2739, WIAS, Berlin, 2020.
- [79] [L. BAÑAS](#), [R. LASARZIK](#), [A. PROHL](#), *Numerical analysis for nematic electrolytes*, Preprint no. 2717, WIAS, Berlin, 2020.
- [80] [N. AHMED](#), [G.R. BARRENECHEA](#), [E. BURMAN](#), [J. GUZMÁN](#), [A. LINKE](#), [CH. MERDON](#), *A pressure-robust discretization of Oseen’s equation using stabilization in the vorticity equation*, Preprint no. 2740, WIAS, Berlin, 2020.

- [81] TH. APEL, V. KEMPF, A. LINKE, CH. MERDON, *A nonconforming pressure-robust finite element method for the Stokes equations on anisotropic meshes*, Preprint no. 2702, WIAS, Berlin, 2020.
- [82] G. FU, CH. LEHRENFELD, A. LINKE, T. STRECKENBACH, *Locking free and gradient robust $H(\text{div})$ -conforming HDG methods for linear elasticity*, Preprint no. 2680, WIAS, Berlin, 2020.
- [83] A. MALTSI, T. NIERMANN, T. STRECKENBACH, K. TABELOW, TH. KOPRUCKI, *Numerical simulation of TEM images for $\text{In}(\text{Ga})\text{As}/\text{GaAs}$ quantum dots with various shapes*, Preprint no. 2682, WIAS, Berlin, 2020.
- [84] O. MARQUARDT, *Simulating the electronic properties of semiconductor nanostructures using multiband $k \cdot p$ models*, Preprint no. 2773, WIAS, Berlin, 2020.
- [85] K.M. GAMBARYAN, O. MARQUARDT, T. BOECK, A. TRAMPERT, *Micro- and nano-scale engineering and structures shape architecture at nucleation from In-As-Sb-P composition liquid phase on an $\text{InAs}(100)$ surface*, Preprint no. 2775, WIAS, Berlin, 2020.
- [86] O. MARQUARDT, M.A. CARO, TH. KOPRUCKI, P. MATHÉ, M. WILLATZEN, *Multiband $k \cdot p$ model and fitting scheme for ab initio-based electronic structure parameters for wurtzite GaAs*, Preprint no. 2699, WIAS, Berlin, 2020.
- [87] P.L. LEDERER, CH. MERDON, *Guaranteed upper bounds for the velocity error of pressure-robust Stokes discretisations*, Preprint no. 2750, WIAS, Berlin, 2020.
- [88] A. MIELKE, *Relating a rate-independent system and a gradient system for the case of one-homogeneous potentials*, Preprint no. 2771, WIAS, Berlin, 2020.
- [89] A. MIELKE, R.R. NETZ, S. ZENDEHROUD, *A rigorous derivation and energetics of a wave equation with fractional damping*, Preprint no. 2718, WIAS, Berlin, 2020.
- [90] J. MAAS, A. MIELKE, *Modeling of chemical reaction systems with detailed balance using gradient structures*, Preprint no. 2712, WIAS, Berlin, 2020.
- [91] A. MIELKE, M.A. PELETIER, A. STEPHAN, *EDP-convergence for nonlinear fast-slow reaction systems with detailed balance*, Preprint no. 2781, WIAS, Berlin, 2020.
- [92] G. NIKA, B. VERNESCU, *Micro-geometry effects on the nonlinear effective yield strength response of magnetorheological fluids*, Preprint no. 2673, WIAS, Berlin, 2020.
- [93] J.-D. DEUSCHEL, T. ORENSHTEIN, G.R. MORENO FLORES, *Aging for the stationary Kardar–Parisi–Zhang equation and related models*, Preprint no. 2763, WIAS, Berlin, 2020.
- [94] J.-D. DEUSCHEL, T. ORENSHTEIN, N. PERKOWSKI, *Additive functionals as rough paths*, Preprint no. 2685, WIAS, Berlin, 2020.
- [95] D. PESCHKA, M. ROSENAU, *Two-phase flows for sedimentation of suspensions*, Preprint no. 2743, WIAS, Berlin, 2020.
- [96] U. GOWDA, A. ROCHE, A. PIMENOV, A.G. VLADIMIROV, S. SLEPNEVA, E.A. VIKTOROV, G. HUYET, *Turbulent coherent structures in a long cavity semiconductor laser near the lasing threshold*, Preprint no. 2724, WIAS, Berlin, 2020.
- [97] G. HU, A. RATHSFELD, *Radiation conditions for the Helmholtz equation in a half plane filled by inhomogeneous periodic material*, Preprint no. 2726, WIAS, Berlin, 2020.
- [98] R. CHILL, H. MEINLSCHMIDT, J. REHBERG, *On the numerical range of second order elliptic operators with mixed boundary conditions in L^p* , Preprint no. 2723, WIAS, Berlin, 2020.
- [99] H. MEINLSCHMIDT, J. REHBERG, *Extrapolated elliptic regularity and application to the van Roosbroeck system of semiconductor equations*, Preprint no. 2705, WIAS, Berlin, 2020.
- [100] D. GABRIELLI, D.R.M. RENGER, *Dynamical phase transitions for flows on finite graphs*, Preprint no. 2746, WIAS, Berlin, 2020.

- [101] M.A. PELETIER, D.R.M. RENGER, *Fast reaction limits via Γ -convergence of the flux rate functional*, Preprint no. 2766, WIAS, Berlin, 2020.
- [102] S. RIEDEL, *Semi-implicit Taylor schemes for stiff rough differential equations*, Preprint no. 2734, WIAS, Berlin, 2020.
- [103] M. GHANI VARZANEH, S. RIEDEL, *A dynamical theory for singular stochastic delay differential equations II: Nonlinear equations and invariant manifolds*, Preprint no. 2701, WIAS, Berlin, 2020.
- [104] M. REDMANN, S. RIEDEL, *Runge–Kutta methods for rough differential equations*, Preprint no. 2708, WIAS, Berlin, 2020.
- [105] R.J.A. LAEVEN, J.G.M. SCHOENMAKERS, N.F.F. SCHWEIZER, M. STADJE, *Robust multiple stopping – A pathwise duality approach*, Preprint no. 2728, WIAS, Berlin, 2020.
- [106] G. THIELE, A. FEY, D. SOMMER, J. KRÜGER, *System identification of a hysteresis-controlled pump system using SINDy*, Preprint no. 2794, WIAS, Berlin, 2020.
- [107] A. KROSHNIN, V. SPOKOINY, A. SUVORIKOVA, *Statistical inference for Bures–Wasserstein barycenters*, Preprint no. 2788, WIAS, Berlin, 2020.
- [108] A. STEPHAN, *EDP-convergence for a linear reaction-diffusion system with fast reversible reaction*, Preprint no. 2793, WIAS, Berlin, 2020.
- [109] L. TAGGI, *Essential enhancements in Abelian networks: Continuity and uniform strict monotonicity*, Preprint no. 2722, WIAS, Berlin, 2020.
- [110] B. LEES, L. TAGGI, *Exponential decay of transverse correlations for spin systems with continuous symmetry and non-zero external field*, Preprint no. 2730, WIAS, Berlin, 2020.
- [111] ———, *Site-monotonicity properties for reflection positive measures with applications to quantum spin systems*, Preprint no. 2713, WIAS, Berlin, 2020.
- [112] K. EBRAHIMI-FARD, F. PATRAS, N. TAPIA, L. ZAMBOTTI, *Wick polynomials in non-commutative probability: A group-theoretical approach*, Preprint no. 2677, WIAS, Berlin, 2020.
- [113] J. DIEHL, K. EBRAHIMI-FARD, N. TAPIA, *Generalized iterated-sums signatures*, Preprint no. 2795, WIAS, Berlin, 2020.
- [114] ———, *Iterated-sums signature, quasi-symmetric functions and time series analysis*, Preprint no. 2736, WIAS, Berlin, 2020.
- [115] ———, *Tropical time series, iterated-sum signatures and quasisymmetric functions*, Preprint no. 2760, WIAS, Berlin, 2020.
- [116] J. DIEHL, R. PREISS, M. RUDDY, N. TAPIA, *The moving frame method for iterated-integrals: Orthogonal invariants*, Preprint no. 2796, WIAS, Berlin, 2020.
- [117] S. BARTELS, M. MILICEVIC, M. THOMAS, N. WEBER, *Fully discrete approximation of rate-independent damage models with gradient regularization*, Preprint no. 2707, WIAS, Berlin, 2020.
- [118] M. THOMAS, S. TORNQUIST, *Discrete approximation of dynamic phase-field fracture in visco-elastic materials*, Preprint no. 2798, WIAS, Berlin, 2020.
- [119] S. BARTELS, M. MILICEVIC, M. THOMAS, S. TORNQUIST, N. WEBER, *Approximation schemes for materials with discontinuities*, Preprint no. 2799, WIAS, Berlin, 2020.
- [120] P. VÁGNER, M. PAVELKA, O. ESEN, *Multiscale thermodynamics of charged mixtures*, Preprint no. 2733, WIAS, Berlin, 2020.
- [121] V. MILOŠ, P. VÁGNER, D. BUDÁČ, M. CARDA, M. PAIDAR, J. FUHRMANN, K. BOUZEK, *Generalized Poisson–Nernst–Planck-based physical model of O_2 | LSM | YSZ electrode*, Preprint no. 2797, WIAS, Berlin, 2020.

- [122] N. PERKOWSKI, W. VAN ZUIJLEN, *Quantitative heat kernel estimates for diffusions with distributional drift*, Preprint no. 2768, WIAS, Berlin, 2020.
- [123] A.V. KOVALEV, P.S. DMITRIEV, A.G. VLADIMIROV, A. PIMENOV, G. HUYET, E.A. VIKTOROV, *Bifurcation structure of a swept source laser*, Preprint no. 2681, WIAS, Berlin, 2020.
- [124] G.L. CELORA, M.G. HENNESSY, A. MÜNCH, B. WAGNER, S.L. WATERS, *A kinetic model of a polyelectrolyte gel undergoing phase separation*, Preprint no. 2802, WIAS, Berlin, 2020.
- [125] G.L. CELORA, M.G. HENNESSY, A. MÜNCH, S.L. WATERS, B. WAGNER, *Spinodal decomposition and collapse of a polyelectrolyte gel*, Preprint no. 2731, WIAS, Berlin, 2020.
- [126] M.G. HENNESSY, G.L. CELORA, A. MÜNCH, S.L. WATERS, B. WAGNER, *Asymptotic study of the electric double layer at the interface of a polyelectrolyte gel and solvent bath*, Preprint no. 2751, WIAS, Berlin, 2020.
- [127] U. WILBRANDT, N. ALIA, V. JOHN, *Optimal control of a buoyancy-driven liquid steel stirring modeled with single-phase Navier–Stokes equations*, Preprint no. 2776, WIAS, Berlin, 2020.
- [128] A. BONI, H.-J. WÜNSCHE, H. WENZEL, P. CRUMP, *Impact of the capture time on the series resistance of quantum-well diode lasers*, Preprint no. 2735, WIAS, Berlin, 2020.
- [129] J.-P. KÖSTER, A. PUTZ, H. WENZEL, H.-J. WÜNSCHE, M. RADZIUNAS, H. STEPHAN, M. WILKENS, A. ZEGHUZI, A. KNIGGE, *Mode competition in broad-ridge-waveguide lasers*, Preprint no. 2764, WIAS, Berlin, 2020.
- [130] E. IPOCOANA, A. ZAFFERI, *Further regularity and uniqueness results for a non-isothermal Cahn–Hilliard equation*, Preprint no. 2716, WIAS, Berlin, 2020.

A.7.2 Preprints/Reports in other Institutions

- [1] S. ATHREYA, O. BUTKOVSKY, K. LÉ, L. MYTNIK, *Well-posedness of stochastic heat equation with distributional drift and skew stochastic heat equation*, arXiv:2011.13498, Cornell University, Ithaca, USA, 2020.
- [2] O. BUTKOVSKY, K. DAREIOTIS, M. GERENCSÉR, *Approximation of SDEs — A stochastic sewing approach*, arXiv:1909.07961, Cornell University, Ithaca, USA, 2020.
- [3] D. DVINSKIKH, *Stochastic approximation versus sample average approximation for population Wasserstein barycenter calculation*, arXiv:2001.07697, Cornell University, Ithaca, USA, 2020.
- [4] D. DVINSKIKH, D. TIAPKIN, *Improved complexity bounds in Wasserstein barycenter problem*, arXiv:2010.04677, Cornell University, Ithaca, USA, 2020.
- [5] D. DVINSKIKH, A. OGALTSOV, A. GASNIKOV, P. DVURECHENSKY, A. TYURIN, V. SPOKOINY, *Adaptive gradient descent for convex and non-convex stochastic optimization*, arXiv:1911.08380, Cornell University, Ithaca, USA, 2020.
- [6] D. DVINSKIKH, A. GASNIKOV, *Decentralized and parallel primal and dual accelerated methods for stochastic convex programming problems*, arXiv:1904.09015, Cornell University, Ithaca, USA, 2020.
- [7] E. GORBUNOV, A. ROGOZIN, A. BEZNOSIKOV, D. DVINSKIKH, A. GASNIKOV, *Recent theoretical advances in decentralized distributed convex optimization*, arXiv:2011.13259, Cornell University, Ithaca, USA, 2020.
- [8] A. SADIEV, A. BEZNOSIKOV, P. DVURECHENSKY, A. GASNIKOV, *Zeroth-order algorithms for smooth saddle-point problems*, arXiv:2009.09908, Cornell University, Ithaca, USA, 2020.
- [9] P. DVURECHENSKY, K. SAFIN, S. SHTERN, M. STAUDIGL, *Generalized self-concordant analysis of Frank–Wolfe algorithms*, arXiv:2010.01009, Cornell University, Ithaca, USA, 2020.
- [10] I. SHIBAEV, P. DVURECHENSKY, A. GASNIKOV, *Zeroth-order methods for noisy Hölder-gradient functions*, arXiv:2006.11857, Cornell University, Ithaca, USA, 2020.

- [11] [P. DVURECHENSKY](#), [S. SHTERN](#), [M. STAUDIGL](#), [P. OSTROUKHOV](#), [K. SAFIN](#), *Self-concordant analysis of Frank-Wolfe algorithms*, arXiv:2002.04320, Cornell University, Ithaca, USA, 2020.
- [12] [N. TUPITSA](#), [P. DVURECHENSKY](#), [A. GASNIKOV](#), [C.A. URIBE](#), *Multimarginal optimal transport by accelerated alternating minimization*, arXiv:2004.02294, Cornell University Library, arXiv.org, Ithaca, USA, 2020.
- [13] [M. DANILOVA](#), [P. DVURECHENSKY](#), [A. GASNIKOV](#), [E. GORBUNOV](#), [S. GUMINOV](#), [D. KAMZOLOV](#), [I. SHIBAEV](#), *Recent theoretical advances in non-convex optimization*, arXiv:2012.06188, Cornell University, Ithaca, USA, 2020.
- [14] [D. TIAPKIN](#), [A. GASNIKOV](#), [P. DVURECHENSKY](#), *Stochastic saddle-point optimization for Wasserstein barycenters*, arXiv:2006.06763, Cornell University, Ithaca, USA, 2020.
- [15] [C. BELLINGERI](#), [P. FRIZ](#), [M. GERENCSÉR](#), *Singular paths spaces and applications*, arXiv:2003.03352, Cornell University, Ithaca, 2020.
- [16] [P. FRIZ](#), [J. GATHERAL](#), [R. RADOIČIĆ](#), *Forests, cumulants, martingales*, arXiv:2002.01448, Cornell University, Ithaca, USA, 2020.
- [17] [P. FRIZ](#), [P. PIGATO](#), [J. SEIBEL](#), *The step stochastic volatility model (SSVM)*, May 7, Available at SSRN's eLibrary: <https://ssrn.com/abstract=3595408> or <http://dx.doi.org/10.2139/ssrn.3595408>, 2020.
- [18] [A. BEZDOSIKOV](#), [V. SAMOKHIN](#), [A. GASNIKOV](#), *Local SGD for saddle-point problems*, arXiv:2010.13112, Cornell University, Ithaca, USA, 2020.
- [19] [A. RASTOGI](#), [P. MATHÉ](#), *Inverse learning in Hilbert scales*, arXiv:2002.10208, Cornell University, Ithaca, USA, 2020.
- [20] [N. PUCHKIN](#), [V. SPOKOINY](#), [E. STEPANOV](#), [D. TREVISAN](#), *Reconstruction of manifold embeddings into Euclidean spaces via intrinsic distances*, arXiv:2012.13770, Cornell University, Ithaca, USA, 2020.
- [21] [N. PUCHKIN](#), [A. TIMOFEEV](#), [V. SPOKOINY](#), *Manifold-based time series forecasting*, arXiv:2012.08244, Cornell University, Ithaca, USA, 2020.

A.8 Talks and Posters

A.8.1 Main and Plenary Talks

1. P. FRIZ, *Diamonds, cumulants, signature cumulants and Magnus expansion (online talk)*, Geometry of Curves in Time Series and Shape Analysis (Online Event), August 11–14, Max-Planck-Institut für Mathematik in den Naturwissenschaften, Leipzig, August 14.
2. B. WAGNER, *Phase-field models of the lithiation/delithiation cycle of thin-film electrodes (online talk)*, Oxford Battery Modelling Symposium (Online Event), March 16–17, University of Oxford, UK, March 16.

A.8.2 Scientific Talks (Invited)

1. L. ANDREIS, *Phase transitions in inhomogeneous random graphs and coagulation processes*, The 3rd Haifa Probability School. Workshop on Random Geometry and Stochastic Analysis, February 24–28, Technion Israel Institute of Technology, Haifa, February 25.
2. ———, *Sparse inhomogeneous random graphs from a large deviation point of view (online talk)*, Probability Seminar (Online Event), University of Bath, Department of Mathematical Sciences, UK, June 1.
3. ———, *The phase transition in random graphs and coagulation processes: A large deviation approach (online talk)*, Seminar of DISMA (Online Event), Politecnico di Torino, Department of Mathematical Sciences (DISMA), Italy, July 14.
4. U. BANDELOW, *Modeling of nonlinear dynamical effects in photonics*, Colloquium of the School of Mathematics and Physics, University of West Australia, Perth, Australia, February 19.
5. ———, *Dynamics of high-power diode lasers (online talk)*, SPIE Photonics Europe (Online Event), April 3–7, April 6.
6. CH. BAYER, *Pricing American options by exercise rate optimization*, Research Seminar on Insurance Mathematics and Stochastic Finance, Eidgenössische Technische Hochschule Zürich, Switzerland, January 9.
7. ———, *Pricing American options by exercise rate optimization*, Mathrisk-INRIA / LPSM Paris-Diderot Seminaire, Inria Paris Research Centre, France, February 6.
8. ———, *Pricing American options by exercise rate optimization*, Lunch at the Lab, University of Calgary, Department of Mathematics and Statistics, Canada, March 3.
9. ———, *Rough volatility*, Summer School 2020 and Annual Meeting of the Berlin–Oxford IRTG 2544 “Stochastic Analysis in Interaction”, September 14–17, Döllnsee, September 15.
10. O. BUTKOVSKY, *Regularization by noise for SDEs and related systems: A tale of two approaches*, Eighth Bielefeld-SNU joint Workshop in Mathematics, February 24–26, Universität Bielefeld, Fakultät für Mathematik, February 24.
11. ———, *Exponential ergodicity of order-preserving SPDEs in the hypoelliptic setting via new coupling techniques (online talk)*, Bernoulli-IMS One World Symposium 2020 (Online Event), August 24–28, August 25.
12. ———, *Skew stochastic heat equation and regularization by noise for PDEs (online talk)*, Bernoulli-IMS One World Symposium 2020 (Online Event), August 24–28, August 27.
13. ———, *New coupling techniques for exponential ergodicity of SPDEs in the hypoelliptic and effectively elliptic settings (online talk)*, Probability Seminar, Heriot-Watt University, Edinburgh, UK, October 21.
14. ———, *Regularization by noise for PDEs – A stochastic sewing approach (online talk)*, FOR 2402 Seminar (Online Event), Technische Universität Berlin, Institut für Mathematik, November 12.

15. D. DVINSKIKH, A. GASNIKOV, *Two approaches for population Wasserstein barycenter problem: Stochastic averaging versus sample average approximation (online talks)*, 2 talks, XII Summer School on Operations Research, Data and Decision Making, May 19–21, Faculty of Informatics, Mathematics and Computer Science, Nizhny Novgorod, Russian Federation, May 20.
16. P. DVURECHENSKY, *Distributed optimization for Wasserstein barycenters (online talk)*, 15th INFORMS Telecommunication and Network Analytics Conference 2020 (Online Event), October 20–21, INFORMS Telecommunications & Networks Analytics, Catonsville, USA, October 21.
17. TH. EITER, *Spatially asymptotic structure of time-periodic Navier–Stokes flows (online talk)*, MA4M: Mathematical Analysis for Mechanics (Online Event), November 23–25, WIAS Berlin, November 24.
18. P. FARRELL, *Numerical methods for innovative semiconductor devices (online talk)*, Technische Universität Dresden, Institut für Wissenschaftliches Rechnen, May 27.
19. M. HEIDA, *Stochastic homogenization on perforated domains*, Friedrich-Alexander Universität Erlangen-Nürnberg, Department Mathematik, July 2.
20. ———, *Stochastic homogenization on perforated domains (online talk)*, MA4M: Mathematical Analysis for Mechanics (Online Event), November 23–25, WIAS Berlin, November 24.
21. M. HINTERMÜLLER, *Functional-analytic and numerical issues in splitting methods for total variation-based image reconstruction*, The Fifth International Conference on Numerical Analysis and Optimization, January 6–9, Sultan Qaboos University, Oman, January 6.
22. ———, *Magnetic resonance fingerprinting of integrated physics models*, Efficient Algorithms in Data Science, Learning and Computational Physics, January 12–16, Sanya, China, January 15.
23. D. HÖMBERG, *Maths for the digital factory (online talk)*, Workshop on Industrial Mathematics and Computer Science (Online Event), University of Craiova, Romania, October 31.
24. K. HOPF, *Global existence analysis of energy-reaction-diffusion systems*, Workshop “Variational Methods for Evolution”, September 13–19, Mathematisches Forschungsinstitut Oberwolfach, September 15.
25. B. JAHNEL, *Phase transitions for the Boolean model for Cox point processes (online talk)*, Bernoulli-IMS One World Symposium 2020 (Online Event), August 24–28, August 27.
26. V. JOHN, *Numerical methods for convection-dominated equations*, 4 talks, Indian Institute of Technology Roorkee, Department of Mathematics, India, January 27–30.
27. W. KÖNIG, *Probabilistic treatment of Bose–Einstein condensation*, Summer School 2020 and Annual Meeting of the Berlin–Oxford IRTG 2544 “Stochastic Analysis in Interaction”, September 14–17, Döllnsee, September 16.
28. R. LASARZIK, *Dissipative solutions in the context of the numerical approximation of nematic electrolytes (online talk)*, Oberseminar Numerik, Universität Bielefeld, Fakultät für Mathematik, June 23.
29. M. LIERO, *Drift-diffusion simulation of S-shaped current-voltage relations for organic semiconductor devices (online talk)*, SimOEP 2020: International Conference on Simulation of Organic Electronics and Photovoltaics (Online Event), August 31 – September 2, Zürcher Hochschule für Angewandte Wissenschaften, Switzerland, September 1.
30. ———, *Evolutionary Gamma-convergence for multiscale problems (online talks)*, 2 talks, Thematic Einstein Semester: Student Compact Course “Variational Methods for Fluids and Solids” (Online Event), October 12–23, WIAS Berlin, October 15.
31. A. LINKE, *Gradient-robustness: A new concept assuring accurate spatial discretizations for vector-valued PDEs*, Workshop “Structure, Regularity and Robustness in the Approximation of PDEs”, Università degli Studi di Milano Statale, Italy, February 10.

32. ———, *Gradient-robustness: A new concept assuring accurate spatial discretizations for vector-valued PDEs (online talk)*, Eindhoven University of Technology, Centre for Analysis, Scientific Computing and Applications, Netherlands, June 24.
33. ———, *On pressure-robust space discretizations and incompressible high Reynolds number flows (online talk)*, Conference on Scientific Computing (ALGORITMY 2020) (Online Event), September 10–15, Slovak University of Technology, Podbanské, Slovakia, September 15.
34. ———, *On the significance of pressure-robustness for locking-free incompressible flow solvers at high Reynolds numbers (online talk)*, Workshop on Modeling and Simulation of Transport Phenomena 2020 (Online Event), October 13–15, Technische Universität Dortmund, Schloss-Hotel Petry, Treis-Karden, October 14.
35. O. MARQUARDT, *Data-driven electronic structure calculations for semiconductor nanostructures*, Efficient Algorithms for Numerical Problems, January 17, WIAS Berlin, January 17.
36. ———, *Electronic properties of semiconductor heterostructures using SPHInX (online tutorial)*, NUSOD 2020: 20th International Conference on Numerical Simulation of Optoelectronic Devices (Online Event), September 14–25, Politecnico di Torino, September 14.
37. P. MATHÉ, *Bayesian inverse problems with non-commuting operators*, University of Edinburgh, School of Mathematics, UK, February 14.
38. A. MIELKE, *Finite-strain viscoelasticity with temperature coupling*, Calculus of Variations and Applications, January 27 – February 1, Scuola Internazionale Superiore di Studi Avanzati (SISSA), Trieste, Italy, January 28.
39. ———, *Gradient systems and evolutionary Gamma-convergence (online talk)*, Oberseminar “Mathematik in den Naturwissenschaften” (Online Event), Julius-Maximilians-Universität Würzburg, June 5.
40. ———, *Similarity solutions for Kolmogorov’s two-equation model for turbulence*, Workshop on Control of Self-Organizing Nonlinear Systems, September 2–3, CRC 910, Technische Universität Berlin, September 2.
41. ———, *Variational structures for the analysis of PDE systems (online talks)*, 2 talks, Thematic Einstein Semester on Energy-based Mathematical Methods for Reactive Multiphase Flows: Student Compact Course “Variational Methods for Fluids and Solids” (Online Event), October 12–23, WIAS Berlin, October 13.
42. ———, *Differential equations as gradient flows, with applications in mechanics, stochastics, and chemistry (online talk)*, Würzburger Mathematisches Kolloquium (Online Event), Julius-Maximilians-Universität Würzburg, November 9.
43. ———, *EDP-convergence for multiscale gradient systems with applications to fast-slow reaction systems (online talk)*, One World Dynamics Seminar (Online Event), Technische Universität München, November 13.
44. ———, *Global existence for finite-strain viscoelasticity with temperature coupling (online talk)*, One World Dynamics Seminar (Online Event), University of Bath, UK, December 1.
45. T. ORENSHTEIN, *Aging for the stationary KPZ equation*, The 3rd Haifa Probability School. Workshop on Random Geometry and Stochastic Analysis, February 24–28, Technion Israel Institute of Technology, Haifa, February 24.
46. ———, *Aging for the stationary KPZ equation (online talk)*, 13th Annual ERC Berlin–Oxford Young Researchers Meeting on Applied Stochastic Analysis (Online Event), June 8–10, WIAS Berlin, June 10.
47. ———, *Aging in Edwards–Wilkinson and KPZ universality classes (online talk)*, Probability, Stochastic Analysis and Statistics Seminar (Online Event), University of Pisa, Italy, October 27.
48. ———, *Rough walks (online talk)*, Mathematics Colloquium (Online Event), Bar Ilan University, Ramat Gan, Israel, November 8.

49. ———, *Aging for the O’Connell–Yor model in intermediate disorder (online talk)*, Joint Israeli Probability Seminar (Online Event), Technion, Haifa, November 17.
50. K. PAPAITSOROS, *Automatic distributed regularization parameter selection in Total Generalized Variation image reconstruction via bilevel optimization*, Seminar, Shenzhen MSU-BIT University, Department of Mathematics, Shenzhen, China, January 16.
51. ———, *Automatic distributed regularization parameter selection in Total Generalized Variation image reconstruction via bilevel optimization*, Seminar, Southern University of Science and Technology, Shenzhen, China, January 17.
52. R.I.A. PATTERSON, *Interpreting LDPs without detailed balance*, Workshop “Variational Methods for Evolution”, September 13–19, Mathematisches Forschungsinstitut Oberwolfach, September 15.
53. P. PELECH, *Separately global solutions to rate-independent systems – Applications to large-strain deformations of damageable solids (online talk)*, MA4M: Mathematical Analysis for Mechanics (Online Event), November 23–25, WIAS Berlin, November 23.
54. D. PESCHKA, *Mathematical modeling and simulation of flows and the interaction with a substrate using energetic variational methods*, CRC 1194 “Interaction between Transport and Wetting Processes”, Technische Universität Darmstadt, January 22.
55. D. PESCHKA, L. HELTAI, *Fluid-structure interaction (online talks)*, 4 talks, Thematic Einstein Semester on Energy-based Mathematical Methods for Reactive Multiphase Flows: Student Compact Course “Variational Methods for Fluids and Solids” (Online Event), October 12–23, WIAS Berlin, October 20–21.
56. J. REHBERG, *Explicit and uniform estimates for second order divergence operators on L^p spaces*, Oberseminar “Analysis und Theoretische Physik”, Leibniz Universität Hannover, Institut für Angewandte Mathematik, January 28.
57. D.R.M. RENGER, *Variational structures and particle systems (online talks)*, 4 talks, Student Compact Course (Online Event), Technische Universität Berlin, October 15–16.
58. S. RIEDEL, *Runge–Kutta methods for rough differential equations (online talk)*, The DNA Seminar (spring 2020), Norwegian University of Science and Technology, Department of Mathematical Sciences, Trondheim, Norway, June 24.
59. H. SI, *On decomposition of embedded prisms in \mathbb{R}^3 without additional points (online talk)*, 10th International Conference “Numerical Geometry, Grid Generation and Scientific Computing” (NUMGRID 2020) (Online Event), November 25–27, Russian Academy of Sciences, Federal Research Center of Information and Control, Moscow, Russian Federation, November 27.
60. V. SPOKOINY, *Bayes inference for non-linear inverse problems*, Workshop “Statistics meets Machine Learning”, January 26–31, Mathematisches Forschungsinstitut Oberwolfach, January 28.
61. ———, *Advanced Statistical Methods*, 3 talks, Higher School of Economics, Faculty of Computer Science, Moscow, Russian Federation, February 11 – March 3.
62. A. STEPHAN, *Coarse-graining via EDP-convergence for linear fast-slow reaction systems*, Seminar “Applied Analysis”, Eindhoven University of Technology, Centre for Analysis, Scientific Computing, and Applications – Mathematics and Computer Science, Netherlands, January 20.
63. ———, *EDP-convergence for nonlinear fast-slow reactions*, Workshop “Variational Methods for Evolution”, September 13–19, Mathematisches Forschungsinstitut Oberwolfach, September 18.
64. ———, *Coarse-graining for gradient systems with applications to reaction systems (online talk)*, Thematic Einstein Semester on Energy-based Mathematical Methods for Reactive Multiphase Flows: Student Compact Course “Variational Methods for Fluids and Solids” (Online Event), October 12–23, WIAS Berlin, October 15.

65. ———, *On gradient flows and gradient systems (online talk)*, CRC 1114 PhD Seminar (Online Event), Freie Universität Berlin, November 11.
66. ———, *On gradient systems and applications to interacting particle systems (online talk)*, CRC 1114 PhD Seminar (Online Event), Freie Universität Berlin, November 25.
67. A. SUVORIKOVA, *Shape-based domain adaptation*, Statistical Seminar of HDI Lab, Higher School of Economics, Faculty of Computer Science, Moscow, Russian Federation, March 2.
68. ———, *Shape-based domain adaptation via optimal transportation (online talk)*, Machine Learning Online Seminar, Max-Planck-Institut für Mathematik in den Naturwissenschaften (MIS), Leipzig, April 1.
69. ———, *Change point detection in high-dimensional data (online talk)*, Joint Aramco-HSE Reserach Seminar, Higher School of Economics, Faculty of Computer Science, Moscow, Russian Federation, April 15.
70. ———, *User-friendly optimal transport (online talk)*, Chromatine Seminar (Online Event), Skolkovo Institute of Science and Technology (Skoltech), Moscow, Russian Federation, August 11.
71. ———, *Optimal transport and its application in bioinformatics*, Second HSE-Yandex Autumn School on Generative Models, November 24–27, National Research University Higher School of Economics, Moscow, Russian Federation, November 27.
72. L. TAGGI, *Macroscopic self-avoiding walk interacting with lattice permutations and uniformly-positive monomer-correlations for the dimer model in Z^d , $d > 2$* , Probability Seminar, University of Warwick, Mathematics Institute, UK, January 16.
73. ———, *Macroscopic self-avoiding walk interacting with lattice permutations and uniformly-positive monomer-monomer correlations in the dimer model in Z^d , $d > 2$* , Probability Seminar, University of Bristol, School of Mathematics, UK, February 7.
74. ———, *Macroscopic self-avoiding walk interacting with lattice permutations and uniformly-positive monomer-monomer correlations in the dimer model in Z^d , $d > 2$ (online talk)*, Probability Seminar (Online Event), University of Bristol, School of Mathematics Research, UK, April 7.
75. ———, *Exponential decay of correlations in the spin and loop $O(N)$ model (online talk)*, Percolation Today (Online Event), Eidgenössische Technische Hochschule Zürich (ETH), Switzerland, October 6.
76. N. TAPIA, *Transport equations with low regularity rough noise*, Young Researchers between Geometry and Stochastic Analysis, February 12–14, University of Bergen, Norway, February 13.
77. ———, *Higher order iterated-sums signatures (online talk)*, DataSig Seminar, University of Oxford, Mathematical Institute, UK, April 2.
78. ———, *Transport and continuity equations with rough noise (online talk)*, The DNA Seminar (spring 2020), Norwegian University of Science and Technology, Department of Mathematical Sciences, Trondheim, Norway, April 22.
79. ———, *Free Wick polynomials (online talk)*, Arbeitsgruppenseminar Analysis, Universität Potsdam, Institut für Mathematik, April 24.
80. ———, *Signatures in shape analysis (online talk)*, Geometry of curves in time series and shape analysis (Online Event), August 11–14, Max-Planck-Institut für Mathematik in den Naturwissenschaften (MIS), Leipzig, August 14.
81. M. THOMAS, *Modeling and analysis of flows of concentrated suspensions (online talk)*, Colloquium of the RTG 2339 “Interfaces, Complex Structures, and Singular Limits” (Online Event), Universität Regensburg, July 10.
82. ———, *Thermodynamical modelling via energy and entropy functionals (online talks)*, 4 talks, Thematic Einstein Semester on Energy-based Mathematical Methods for Reactive Multiphase Flows: Student Compact Course “Variational Methods for Fluids and Solids” (Online Event), October 12–23, WIAS Berlin, October 12–19.

83. S. TORNQVIST, *Dynamic phase-field fracture in visco-elastic materials (online talk)*, Thematic Einstein Semester on Energy-based Mathematical Methods for Reactive Multiphase Flows: Student Compact Course “Variational Methods for Fluids and Solids” (Online Event), October 12–23, WIAS Berlin, October 14.
84. ———, *Temporal regularity of solutions to a dynamic phase-field fracture model in visco-elastic materials (online talk)*, MA4M: Mathematical Analysis for Mechanics (Online Event), November 23–25, WIAS Berlin, November 23.
85. W. VAN ZUIJLEN, *Spectral asymptotics of the Anderson Hamiltonian*, Forschungsseminar “Functional Analysis“, Karlsruher Institut für Technologie, Fakultät für Mathematik, Institut für Analysis, January 21.
86. ———, *Large time behaviour of the parabolic Anderson model (online talk)*, Probability Seminar, Universidade Federal da Bahia, Instituto de Matematica Doutorado em Matematica (Online Event), Salvador, Brazil, October 21.
87. B. WAGNER, *Pattern formation in dewetting films (online talk)*, Workshop “Mathematical Modeling and Scientific Computing: Focus on Complex Processes and Systems” (Online Event), November 19–20, Technische Universität München, November 19.
88. M. WOLFRUM, *Temporal dissipative solitons in systems with time delay*, Séminaire Orléans, Institut Denis Poisson, Orléans, France, January 23.
89. A. ZAFFERI, *Lagrangian–Eulerian reduction of GENERIC systems (online talk)*, Thematic Einstein Semester on Energy-based Mathematical Methods for Reactive Multiphase Flows: Student Compact Course “Variational Methods for Fluids and Solids” (Online Event), October 12–23, WIAS Berlin, October 12.

A.8.3 Talks for a More General Public

1. P. FRIZ, *Raue Analysis*, MATH+, MATHINSIDE, Urania Berlin, January 28.
2. B. JAHNEL, *Murphy’s law oder die Entropie des tippenden Affen*, MATH+, MATHINSIDE, Urania Berlin, January 28.
3. W. KÖNIG, *Paradoxa in der Wahrscheinlichkeitsrechnung*, MATH+, MATHINSIDE, Urania Berlin, January 28.

A.8.4 Posters

1. G. DONG, *Integrated physics-based method, learning-informed model and hyperbolic PDEs for imaging*, Efficient Algorithms in Data Science, Learning and Computational Physics, Sanya, China, January 12–16.
2. D. DVINSKIKH, A. GASNIKOV, *SA vs SAA for population Wasserstein barycenter calculation*, Math of Machine Learning 2020, Sochi, Russian Federation, February 19–22.
3. N. DROPKA, P. FARRELL, ST. KAYSER, N. ROTUNDO, *Numerics for innovative semiconductor devices – An outlook*, German Conference on Crystal Growth, Munich, March 11–13.
4. P. FARRELL, D. PESCHKA, *Challenges in drift-diffusion semiconductor simulations*, Finite Volumes for Complex Applications IX (Online Event), Bergen, Norway, June 15–19.
5. C. CANCÈS, C. CHAINAIS-HILLAIRET, J. FUHRMANN, B. GAUDEUL, *On four numerical schemes for a unipolar degenerate drift-diffusion model*, Finite Volumes for Complex Applications IX (Online Event), Bergen, Norway, June 15–19.
6. J. FUHRMANN, D.H. DOAN, A. GLITZKY, M. LIERO, G. NIKA, *Unipolar drift-diffusion simulation of S-shaped current-voltage relations for organic semiconductor devices*, Finite Volumes for Complex Applications IX (Online Event), Bergen, Norway, June 15–19.

7. J. FUHRMANN, C. GUHLKE, M. LANDSTORFER, A. LINKE, CH. MERDON, R. MÜLLER, *Quality preserving numerical methods for electroosmotic flow*, Einstein Semester on Energy-based Mathematical Methods for Reactive Multiphase Flows: Kick-off Conference (Online Event), October 26–30.
8. M. HEIDA, A. MIELKE, A. STEPHAN, *Effective models for materials and interfaces with multiple scales*, CRC 1114: Scaling Cascades in Complex Systems (SCCS Days) (Online Event), December 2–4.
9. R. HENRION, W. ACKOIJ, *Analysis of a two-stage probabilistic programming model*, PGMO Days 2020 (Online Event), Palaiseau, France, December 1.
10. V. JOHN, *On the provable convergence order for the kinetic energy of FEMs for the incompressible Navier–Stokes equations*, 7th European Seminar on Computing (ESCO 2020) (Online Event), Pilsen, Czech Republic, June 8–12.
11. TH. KOPRUCKI, K. TABELOW, T. STRECKENBACH, T. NIERMANN, A. MALTSI, *Model-based geometry reconstruction of TEM images*, MATH+ Day 2020 (Online Event), Berlin, November 6.
12. M. LIERO, A. MIELKE, *Analysis for thermo-mechanical models with internal variables*, Presentation of project proposals in DFG SPP 2256 “Variational Methods for Predicting Complex Phenomena in Engineering Structures and Materials”, Bad Honnef, January 30.
13. A. LINKE, CH. MERDON, *On the significance of pressure-robustness for the space discretization of incompressible high Reynolds number flows*, Finite Volumes for Complex Applications IX (Online Event), Bergen, Norway, June 15–19.
14. ———, *On high-order pressure-robust space discretisations, their advantages for incompressible high Reynolds number generalised Beltrami flows and beyond*, Einstein Semester on Energy-based Mathematical Methods for Reactive Multiphase Flows: Kick-off Conference (Online Event), Berlin, October 26–30.
15. O. MARQUARDT, TH. KOPRUCKI, A. MIELKE, *DESCANT – Data-driven electronic structure calculations for semiconductor nanostructures*, MATH+ Day 2020 (Online Event), Berlin, November 6.
16. K. PAPANITSOROS, *Spatially dependent parameter selection in TGV based image restoration via bilevel optimization*, Efficient Algorithms in Data Science, Learning and Computational Physics, Sanya, China, January 12–16.
17. P. PELECH, *Separately global solutions to rate-independent systems: Applications to large-strain deformations of damageable solids*, Thematic Einstein Semester: Student Compact Course “Variational Methods for Fluids and Solids” (Online Event), October 12–23.
18. D. PESCHKA, *Modeling and simulation of wetting and dewetting with dynamic contact angles*, Wetting Dynamics 2020, Bonn, September 28–30.
19. M.H. FARSHBAF SHAKER, D. PESCHKA, M. THOMAS, *Modeling and analysis of suspension flows*, MATH+ Day 2020 (Online Event), Berlin, November 6.
20. D.M. RENGER, *Fast reaction limits via Gamma-convergence of the flux rate functional*, CRC 1114: Scaling Cascades in Complex Systems (SCCS Days) (Online Event), December 2–4.
21. A. KROSHNIN, A. SUVORIKOVA, V. SPOKOINY, *Statistical inference on Bures–Wasserstein space: From theory to practice*, Math of Machine Learning 2020, Sochi, Russian Federation, February 19–22.
22. M. THOMAS, *Nonlinear fracture dynamics: Modeling, analysis, approximation, and applications*, Presentation of project proposals in SPP 2256 “Variational Methods for Predicting Complex Phenomena in Engineering Structures and Materials”, Bad Honnef, January 30.
23. A. ZAFFERI, K. HUBER, *Dynamics of rock dehydration*, CRC 1114: Scaling Cascades in Complex Systems (SCCS Days) (Online Event), December 2–4.

A.9 Visits to other Institutions⁶

1. CH. BAYER, Eidgenössische Technische Hochschule Zürich, Fachbereich Mathematik, Switzerland, January 7–10.
2. ———, Inria Paris Research Centre, Mathrisk Research Team, France, February 6–11.
3. ———, University of Calgary, Department of Mathematics and Statistics, Canada, March 2–6.
4. P.-É. DRUET, Technische Universität Darmstadt, Fachbereich Mathematik, January 26–29.
5. D. DVINSKIKH, Sirius University of Science and Technology, Sochi, Russian Federation, February 17–25.
6. D. HÖMBERG, Adjunct Professorship, Norwegian University of Science and Technology, Department of Mathematical Sciences, Trondheim, Norway, February 17–28.
7. V. JOHN, Indian Institute of Technology Roorkee, Department of Mathematics, India, January 20–31.
8. ———, Universidad Autónoma de Madrid, Departamento de Matemáticas, Spain, March 2–6.
9. W. KÖNIG, Westfälische Wilhelms-Universität Münster, Fachbereich Mathematik und Informatik, January 20–24.
10. A. LINKE, Università degli Studi di Milano Statale, Dipartimento di Matematica, Italy, February 10–14.
11. G. NIKA, Worcester Polytechnic Institute, Department of Mathematical Sciences, USA, January 2–18.
12. T. ORENSHTEIN, The Weizmann Institute of Science, Department of Mathematics, Rehovot, Israel, February 29 – March 8.
13. V. SPOKOINY, Higher School of Economics, Faculty of Computer Science, Moscow, Russian Federation, February 11 – March 6.
14. A. STEPHAN, Eindhoven University of Technology, Department of Mathematics and Computer Science, Netherlands, January 20–24.
15. A. SUVORIKOVA, Higher School of Economics, Faculty of Computer Science, Moscow, Russian Federation, February 10 – March 9.
16. L. TAGGI, University of Warwick, Mathematics Institute, UK, January 14–17.
17. ———, University of Bristol, School of Mathematics, UK, February 3–7.
18. W. VAN ZUIJLEN, Karlsruher Institut für Technologie, Fakultät für Mathematik, Institut für Analysis, January 20–24.
19. ———, Université Paris Dauphine, Centre de Recherches en Mathématiques de la Décision, France, January 27–31.
20. ———, Universidade Federal de Minas Gerais (UFMG), Departamento de Matemática/ICEx, Belo Horizonte, Brazil, February 11–21.
21. ———, Universidade Federal da Bahia, Instituto de Matematica Doutorado em Matematica, Salvador, Brazil, March 17–20.
22. B. WAGNER, University of Oxford, Mathematical Institute, UK, January 20–24.
23. M. WOLFRUM, Institut Denis Poisson, Orléans, France, January 20–24.

⁶Only stays of more than three days are listed.

A.10 Academic Teaching⁷

Winter Semester 2019/2020

1. U. BANDELOW, *Mathematische Modelle der Photonik* (research seminar), Humboldt-Universität zu Berlin/WIAS Berlin, 2 SWS.
2. P. DVURECHENSKY, *Recent Developments in Optimization Methods and Machine Learning Applications* (lecture), Humboldt-Universität zu Berlin, 2 SWS.
3. ———, *Recent Developments in Optimization Methods and Machine Learning Applications* (practice), Humboldt-Universität zu Berlin, 1 SWS.
4. M.H. FARSHBAF SHAKER, *Optimalsteuerung bei partiellen Differentialgleichungen* (lecture), Technische Universität Berlin, 4 SWS.
5. P. FRIZ, *Oberseminar Rough Paths, Stochastic Partial Differential Equations and Related Topics* (senior seminar), Technische Universität Berlin, 2 SWS.
6. ———, *Stochastik und Finanzmathematik* (practice), Technische Universität Berlin, 2 SWS.
7. P. FRIZ, CH. BAYER, *Rough Volatility, Rough Paths and Related Topics* (lecture), Technische Universität Berlin, 2 SWS.
8. J. FUHRMANN, *Wissenschaftliches Rechnen (Scientific Computing)* (lecture), Technische Universität Berlin, 4 SWS.
9. A. GLITZKY, *Ausgewählte Themen der Optimierung (M23): Einführung in die Kontrolltheorie und optimale Steuerung* (lecture), Humboldt-Universität zu Berlin, 2 SWS.
10. ———, *Ausgewählte Themen der Optimierung (M23): Einführung in die Kontrolltheorie und optimale Steuerung* (practice), Humboldt-Universität zu Berlin, 1 SWS.
11. A. GLITZKY, A. MIELKE, B. ZWICKNAGL, *Nichtlineare partielle Differentialgleichungen (Langenbach-Seminar)* (senior seminar), Humboldt-Universität zu Berlin/WIAS Berlin, 2 SWS.
12. M. HEIDA, *Homogenization* (lecture), Technische Universität München, 2 SWS.
13. ———, *Nonlinear Analysis* (lecture), Technische Universität München, 4 SWS.
14. ———, *Nonlinear Analysis* (practice), Technische Universität München, 2 SWS.
15. M. HINTERMÜLLER, *Joint Research Seminar on Nonsmooth Variational Problems and Operator Equations / Mathematical Optimization* (research seminar), Humboldt-Universität zu Berlin/WIAS Berlin, 2 SWS.
16. D. HÖMBERG, *Nichtlineare Optimierung* (seminar), Technische Universität Berlin, 2 SWS.
17. O. KLEIN, *Ausgewählte Themen der angewandten Analysis (M38): Mathematische Modellierung von Hystereseeffekten* (lecture), Humboldt-Universität zu Berlin, 2 SWS.
18. ———, *Ausgewählte Themen der angewandten Analysis (M38): Mathematische Modellierung von Hystereseeffekten* (practice), Humboldt-Universität zu Berlin, 1 SWS.
19. A. MIELKE, *Mehrdimensionale Variationsrechnung* (lecture), Humboldt-Universität zu Berlin, 4 SWS.
20. ———, *Mehrdimensionale Variationsrechnung* (practice), Humboldt-Universität zu Berlin, 2 SWS.
21. D. PESCHKA, *Numerische Mathematik II für Ingenieure* (lecture), Technische Universität Berlin, 4 SWS.
22. V. SPOKOINY, *Modern Methods in Applied Stochastics and Nonparametric Statistics* (seminar), Humboldt-Universität zu Berlin/WIAS Berlin, 2 SWS.

⁷SWS = semester periods per week

23. V. SPOKOINY, W. HÄRDLE, M. REISS, S. GREVEN, *Mathematical Statistics* (research seminar), Humboldt-Universität zu Berlin/Universität Potsdam/WIAS Berlin, 2 SWS.
24. H. STEPHAN, *Funktionalanalytische Methoden in der klassischen Physik* (lecture), Humboldt-Universität zu Berlin, 2 SWS.
25. ———, *Funktionalanalytische Methoden in der klassischen Physik* (practice), Humboldt-Universität zu Berlin, 1 SWS.
26. K. TABELOW, *Mathematik* (seminar), Steinbeis-Hochschule Berlin, 2 SWS.
27. M. THOMAS, *Funktionalanalysis* (lecture), Universität Kassel, 4 SWS.
28. ———, *Nichtlineare Funktionalanalysis* (lecture), Universität Kassel, 4 SWS.
29. M. WOLFRUM, B. FIEDLER, *Nonlinear Dynamics* (senior seminar), Freie Universität Berlin/WIAS Berlin, 2 SWS.

Summer Semester 2020

1. U. BANDELOW, *Online: Mathematische Modelle der Photonik* (research seminar), Humboldt-Universität zu Berlin/WIAS Berlin, 2 SWS.
2. M. EIGEL, *Online: Tensorproduktapproximation für hochdimensionale PDEs und Maschinelles Lernen* (lecture), Technische Universität Berlin, 2 SWS.
3. P. FRIZ, *Online: Oberseminar Rough Paths, Stochastic Partial Differential Equations and Related Topics* (senior seminar), Technische Universität Berlin, 2 SWS.
4. ———, *Online: Stochastik und Finanzmathematik* (practice), Technische Universität Berlin, 2 SWS.
5. A. GLITZKY, A. MIELKE, B. ZWICKNAGL, *Online: Nichtlineare partielle Differentialgleichungen (Langenbach-Seminar)* (senior seminar), Humboldt-Universität zu Berlin/WIAS Berlin, 2 SWS.
6. M. HEIDA, *Online: Differentialgleichungen für Ingenieure* (lecture), Technische Universität Berlin, 2 SWS.
7. M. HINTERMÜLLER, *Online: Ausgewählte Themen der Optimierung (M23): Mathematical Programs with Equilibrium Constraints / Mathematische Optimierung unter Gleichgewichtsrestriktionen* (lecture), Humboldt-Universität zu Berlin, 2 SWS.
8. D. HÖMBERG, *Online: Nichtlineare Optimierung* (lecture), Technische Universität Berlin, 4 SWS.
9. B. JAHNEL, L. TAGGI, *Online: Spin Systems and Phase Transitions* (lecture), Technische Universität Berlin, 2 SWS.
10. ———, *Online: Student's Seminar on Spin Systems and Phase Transitions* (seminar), Technische Universität Berlin, 2 SWS.
11. V. JOHN, *Online: Numerik I* (lecture), Freie Universität Berlin, 4 SWS.
12. W. KÖNIG, *Online: Wahrscheinlichkeitstheorie I* (lecture), Technische Universität Berlin, 4 SWS.
13. M. LANDSTORFER, *Online: Mathematische Modellierung mit Differentialgleichungen* (lecture), Technische Universität Berlin, 4 SWS.
14. D. PESCHKA, *Online: Numerical Methods for Fluid Flows* (lecture), Technische Universität Berlin, 2 SWS.
15. ———, *Online: Numerical Methods for Fluid Flows* (practice), Technische Universität Berlin, 2 SWS.
16. D.R.M. RENGER, *Online: Große Abweichungen* (lecture), Technische Universität Berlin, 2 SWS.
17. V. SPOKOINY, *Online: Mathematische Statistik* (lecture), Humboldt-Universität zu Berlin, 4 SWS.

18. ———, *Online: Modern Methods in Applied Stochastics and Nonparametric Statistics* (seminar), Humboldt-Universität zu Berlin/WIAS Berlin, 2 SWS.
19. ———, *Online: Mathematische Statistik* (practice), Humboldt-Universität zu Berlin, 2 SWS.
20. V. SPOKOINY, W. HÄRDLE, M. REISS, S. GREVEN, *Online: Mathematical Statistics* (research seminar), Humboldt-Universität zu Berlin/Universität Potsdam/WIAS Berlin, 2 SWS.
21. K. TABELOW, *Online: Mathematik* (seminar), Steinbeis-Hochschule Berlin, 2 SWS.
22. W. VAN ZUIJLEN, *Online: Theory of Function Spaces and Applications* (lecture), Freie Universität Berlin, 2 SWS.
23. M. WOLFRUM, B. FIEDLER, I. SCHNEIDER, E. SCHÖLL, *Online: Nonlinear Dynamics* (senior seminar), Freie Universität Berlin/WIAS Berlin/Technische Universität Berlin, 2 SWS.

Winter Semester 2020/2021

1. U. BANDELOW, *Online: Mathematische Modelle der Photonik* (research seminar), Humboldt-Universität zu Berlin/WIAS Berlin, 2 SWS.
2. P.-É. DRUET, *Online: Nonlinear Partial Differential Equations* (lecture), Humboldt-Universität zu Berlin, 4 SWS.
3. ———, *Online: Nonlinear Partial Differential Equations* (practice), Humboldt-Universität zu Berlin, 2 SWS.
4. P. DVURECHENSKY, *Online: Theory of Optimization Algorithms for Large-scale Problems Motivated by Machine Learning Applications* (lecture), Humboldt-Universität zu Berlin, 2 SWS.
5. ———, *Online: Theory of Optimization Algorithms for Large-scale Problems Motivated by Machine Learning Applications* (practice), Humboldt-Universität zu Berlin, 1 SWS.
6. M.H. FARSHBAF SHAKER, *Online: Mathematik für Ingenieure C1* (lecture), Friedrich-Alexander-Universität Erlangen-Nürnberg, 4 SWS.
7. ———, *Online: Übungen zur Mathematik für Ingenieure C1* (practice), Friedrich-Alexander-Universität Erlangen-Nürnberg, 2 SWS.
8. P. FRIZ, *Online: Oberseminar Rough Paths, Stochastic Partial Differential Equations and Related Topics* (senior seminar), Technische Universität Berlin, 2 SWS.
9. J. FUHRMANN, *Online: Wissenschaftliches Rechnen (Scientific Computing)* (lecture), Technische Universität Berlin, 4 SWS.
10. A. GLITZKY, A. MIELKE, B. ZWICKNAGL, *Online: Nichtlineare partielle Differentialgleichungen (Langenbach-Seminar)* (senior seminar), Humboldt-Universität zu Berlin/WIAS Berlin, 2 SWS.
11. D. HÖMBERG, *Online: Nichtlineare Optimierung* (seminar), Technische Universität Berlin, 2 SWS.
12. V. JOHN, *Online: Numerical Mathematics 2* (lecture), Freie Universität Berlin, 4 SWS.
13. O. KLEIN, *Online: Spezielle Themen der Mathematik (M39): Einführung in die Quantifizierung von Unsicherheiten, Uncertainty Quantification* (lecture), Humboldt-Universität zu Berlin, 2 SWS.
14. ———, *Online: Spezielle Themen der Mathematik (M39): Einführung in die Quantifizierung von Unsicherheiten, Uncertainty Quantification* (practice), Humboldt-Universität zu Berlin, 1 SWS.
15. W. KÖNIG, *Online: Probability Theory II* (lecture), Technische Universität Berlin, 4 SWS.
16. Z. LAKDAWALA, *Online: Numerical and Applied Linear Algebra (mid Sept. to Dec. 9, co-lecturer)* (lecture), Lahore University of Management Sciences, Pakistan, 2 SWS.

17. M. LANDSTORFER, *Online: Numerische Mathematik II für Ingenieure* (lecture), Technische Universität Berlin, 2 SWS.
18. A. LINKE, *Online: Mathematik für Geowissenschaftler I* (lecture), Freie Universität Berlin, 2 SWS.
19. V. SPOKOINY, *Online: Modern Methods in Applied Stochastics and Nonparametric Statistics* (seminar), Humboldt-Universität zu Berlin/WIAS Berlin, 2 SWS.
20. V. SPOKOINY, W. HÄRDLE, M. REISS, S. GREVEN, *Online: Mathematical Statistics* (research seminar), Humboldt-Universität zu Berlin/Universität Potsdam/WIAS Berlin, 2 SWS.
21. K. TABELOW, *Online: Mathematik* (seminar), Steinbeis-Hochschule Berlin, 2 SWS.
22. M. WOLFRUM, B. FIEDLER, I. SCHNEIDER, E. SCHÖLL, *Online: Nonlinear Dynamics* (senior seminar), Freie Universität Berlin/WIAS Berlin/Technische Universität Berlin, 2 SWS.

A.11 Visiting Scientists⁸

A.11.1 Guests

1. G.R. BARRENECHEA, University of Strathclyde, Department of Mathematics and Statistics, Glasgow, UK, February 11–15.
2. P. BERG, University of Alberta, Department of Science, Canada, October 1 – November 20.
3. G. BLANCHARD, Université Paris-Saclay, L'Institut des Hautes Etudes Scientifiques (IHES), Bures-sur-Yvette, France, January 13–18.
4. M. BROKATE, Technische Universität München, Zentrum Mathematik, Garching, July 8, 2019 – December 31, 2020.
5. P. DAS, EFD Induction AS, Skien, Norway, February 10–14.
6. M. FENZL, Universität Zürich, Institut für Mathematik, Switzerland, January 13–17.
7. A. GASNIKOV, Moscow Institute of Physics and Technology (MIPT), Department of Control/Management and Applied Mathematics, Dolgoprudny, Moscow Region, Russian Federation, December 27, 2019 – January 27, 2020.
8. ———, October 12–31.
9. P. HAGER, Technische Universität Berlin, Institut für Mathematik, January 1 – April 30.
10. ———, June 1, 2020 – December 31, 2021.
11. F.A. HARANG, University of Oslo, Department of Mathematics, Norway, January 27–31.
12. L. HELTAI, Scuola Internazionale Superiore di Studi Avanzati (SISSA), Mathematical Analysis, Modeling, and Applications, Trieste, Italy, October 11–29.
13. M. HEYDENREICH, Universität München, Mathematisches Institut, September 2–5.
14. H. HOEL, RWTH Aachen, Fachgruppe Mathematik, Lehrstuhl für Mathematics of Uncertainty Quantification, Aachen, February 24–27.
15. J. HOLLEY, Robert Bosch GmbH, January 1 – March 31.
16. O. HUBER, Humboldt-Universität zu Berlin, Institut für Mathematik, January 1 – December 31.
17. A. IVANOVA, Moscow Institute of Physics and Technology (MIPT), Department of Control/Management and Applied Mathematics, Dolgoprudny, Moscow Region, Russian Federation, January 20 – February 1.
18. D. KAMZOLOV, Moscow Institute of Physics and Technology (MIPT), Department of Control/Management and Applied Mathematics, Dolgoprudny, Moscow Region, Russian Federation, January 7 – February 6.
19. R. KRAVCHENKO, Humboldt-Universität zu Berlin, Institut für Mathematik, Berlin, July 1, 2019 – December 31, 2021.
20. P. LEDERER, Technische Universität Wien, Institut für Analysis und Scientific Computing, Austria, February 23–27.
21. A. MÜNCH, University of Oxford, Oxford Center for Industrial and Applied Mathematics, Mathematical Institute, UK, March 18–31.
22. P. PIGATO, University of Rome Tor Vergata, Department of Economics and Finance, Italy, November 28, 2019 – February 29, 2020.

⁸Only stays of more than three days are listed.

23. R. PYMAR, Birkbeck University of London, Department of Economics, Mathematics and Statistics, UK, February 3–21.
24. S. RIEDEL, Technische Universität Berlin, Institut für Mathematik, November 1 – December 31.
25. E. SACHS, Universität Trier, Fachbereich IV, Numerik, March 30 – April 3.
26. A. STEPHAN, Deutsches Zentrum für Luft- und Raumfahrt (DLR), Institut für Physik der Atmosphäre, Weßling, February 24–28.
27. Y. SUN, Humboldt-Universität zu Berlin, Institut für Mathematik, January 1 – September 30.
28. F.J.E. TELSCHOW, University of California San Diego, Department of Family and Preventive Medicine, La Jolla CA, USA, February 1 – December 31.
29. N. TORRI, Université Paris Nanterre, Laboratoire d'Analyse et de Mathématiques, Nanterre, France, February 22–26.
30. B. ZALTZMAN, Ben Gurion University of the Negev, Jacob Blaustein Institute for Desert Research, Sede Boqer Campus, Israel, March 3 – August 31.

A.11.2 Scholarship Holders

1. A. JHA, New Delhi, India, Berlin Mathematical School, October 1, 2017 – October 31, 2020.
2. CH. KWOFIE, University of Energy and Natural Resources, Sunyani, Ghana, DAAD Fellowship, February 1, 2018 – June 30, 2021.

A.11.3 Doctoral Candidates and Post-docs supervised by WIAS Collaborators

1. P. HAGER, Technische Universität Berlin, supervisor: Prof. Dr. P. Friz, Technische Universität Berlin, doctoral candidate, January 1 – December 31.
2. J. HOLLEY, Humboldt-Universität zu Berlin, Institut für Mathematik, supervisor: Prof. Dr. M. Hintermüller, Robert Bosch GmbH, doctoral candidate, January 1 – March 31.
3. A. JHA, Freie Universität Berlin, Institut für Mathematik, supervisor: Prof. Dr. V. John, Berlin Mathematical School, doctoral candidate, January 1 – September 30.
4. R. KRAVCHENKO, Humboldt-Universität zu Berlin, Institut für Mathematik, supervisor: Prof. Dr. V. Spokoiny, MATH+, doctoral candidate, January 1 – December 31.
5. Y. SUN, Humboldt-Universität zu Berlin, Mathematisch-Naturwissenschaftliche Fakultät, supervisor: Prof. Dr. V. Spokoiny, Berlin Mathematical School, doctoral candidate, January 1 – December 31.

A.12 Guest Talks

1. CH. AMORINO, Université d'Évry-Val-d'Essonne, Département de Mathématiques, Évry, France, *Invariant adaptive density estimation for ergodic SDE with jumps over anisotropic classes (online talk)*, May 20.
2. A. BACH, Technische Universität München, Fakultät für Mathematik, *Geometrically frustrated spin systems: The antiferromagnetic XY model on the triangular lattice (online talk)*, November 25.
3. F. BACHOC, Université Paul Sabatier, Institut de Mathématiques, Toulouse, France, *Valid confidence intervals post-model selection (online talk)*, June 17.
4. S. BAGULEY, Universität Mannheim, Institut für Mathematik, *Perpetual integrals for stable SDEs (online talk)*, May 13.
5. G.R. BARRENECHEA, University of Strathclyde, Department of Mathematics and Statistics, Glasgow, UK, *Low-order divergence-free finite element methods*, February 13.
6. P. BERG, University of Alberta, Department of Science, Canada, *From microscale to macroscale properties of polymer electrolyte membranes: A case for pore network models (online talk)*, November 17.
7. ST.A. BETHUELSEN, University of Bergen, Department of Mathematics, Norway, *Invariance principle for random walks on dynamically averaging random conductances (online talk)*, November 11.
8. H. BONDELL, University of Melbourne, School of Mathematics and Statistics, Australia, *Bayesian regression for high-dimensional data using a prior on the model fit (online talk)*, December 16.
9. T. BREITEN, Technische Universität Berlin, Institut für Mathematik, *Optimal feedback control and minimum energy estimation by value function approximations (online talk)*, September 29.
10. A. CARPENTIER, Universität Magdeburg, Institut für Mathematische Stochastik, *Adaptive inference and its relations to sequential decision making*, February 12.
11. R.M. COLOMBO, University of Brescia, INdAM Unit, Italy, *A hyperbolic-parabolic system to model and control parasites through parasitoids (online talk)*, June 9.
12. TH. DICKHAUS, Universität Bremen, Institut für Statistik, *How many null hypotheses are false? (online talk)*, April 29.
13. G. DUDA, Charité Berlin, Julius Wolff Institute for Biomechanics and Musculoskeletal Regeneration, *From mechanical forces to tissue straining – How to employ biophysical cues to guide regeneration*, February 3.
14. M. FENZL, Universität Zürich, Institut für Mathematik, Switzerland, *Asymptotic results for stabilizing geometric statistics*, January 15.
15. A. GASNIKOV, Moscow Institute of Physics and Technology (MIPT), Department of Control/Management and Applied Mathematics, Dolgoprudny, Moscow Region, Russian Federation, *An overview of distributed optimization*, January 14.
16. J. GINSTER, Humboldt-Universität zu Berlin, Institut für Mathematik, *On the motion of curved dislocations in three dimensions: Simplified linearized elasticity (online talk)*, November 18.
17. M. GRMELA, Polytechnique Montréal, Département de Génie Chimique, Canada, *Multiscale thermodynamics (online talk)*, November 26.
18. P. HAGER, Technische Universität Berlin, Institut für Mathematik, *Reinforced optimal control (online talk)*, July 7.
19. ST. HEINRICH, Universität Kaiserslautern, Fachbereich Informatik, *Quantum computing for numerical problems – Algorithms and complexity*, January 17.
20. H. HOEL, Rheinisch-Westfälische Technische Hochschule Aachen, Fachbereich Mathematik, *Multilevel ensemble Kalman filtering algorithms*, February 25.

21. A. IVANOVA, Moscow Institute of Physics and Technology (MIPT), Department of Control/Management and Applied Mathematics, Dolgoprudny, Moscow Region, Russian Federation, *Optimization methods for resource allocation problem*, January 28.
22. P.E. JACOB, Harvard University, Department of Statistics, USA, *Unbiased Markov chain Monte Carlo methods with couplings (online talk)*, November 4.
23. N. KLEIN, Humboldt-Universität zu Berlin, Wirtschaftswissenschaftliche Fakultät, *Bayesian regression copulas*, January 29.
24. Y. KLOCHKOV, University of Cambridge, Faculty of Economics, UK, *Robust K-means clustering under two moments (online talk)*, December 2.
25. R. KRAVCHENKO, Humboldt-Universität zu Berlin, Institut für Mathematik, *Distributed optimization with quantization for computing Wasserstein barycenters (online talk)*, December 1.
26. A. KREISS, Catholic University of Leuven, Research Centre for Operations Research and Statistics (ORSTAT), Belgium, *Correlation bounds, mixing and m -dependence under random time-varying network distances with an application to Cox processes (online talk)*, November 25.
27. M. KRUŽÍK, Czech Academy of Sciences, Institute of Information Theory and Automation, Prague, Czech Republic, *Equilibrium for multiphase solids with Eulerian interfaces (online talk)*, December 10.
28. P. LEDERER, Technische Universität Wien, Institut für Analysis und Scientific Computing, Austria, *Divergence-free tangential finite element methods for incompressible flows on surfaces*, February 27.
29. D. LIEBL, Universität Bonn, Finanzwirtschaft und Statistik, *Fast and fair simultaneous confidence bands for functional parameters*, January 8.
30. M. LÖFFLER, ETH Zürich, Department of Mathematics, Switzerland, *Computationally efficient sparse clustering (online talk)*, November 18.
31. J. MATEU, Universitat Jaume I, Departamento de Matemáticas, Castelló de la Plana, Spain, *Complex spatial and spatio-temporal point process dependencies: Linear ANOVA-type models, metrics and barycenters and predictive stochastic models of crime*, January 22.
32. S. MAZZONETTO, Universität Potsdam, Institut für Mathematik, *Threshold Ornstein–Uhlenbeck model: Parameters estimation (online talk)*, June 23.
33. S. NECHAYEV, Ferdinand-Braun-Institut, Berlin, *Towards LDSL-based multiphysics modeling of semiconductor lasers: Ideals and challenges (online talk)*, November 24.
34. J. NILES-WEED, New York University, Courant Institute of Mathematical Sciences and Center for Data Science, USA, *Minimax estimation of smooth densities in Wasserstein distance (online talk)*, June 10.
35. G. PEYRÉ, École Normale Supérieure, Département de Mathématiques et Applications, Paris, France, *Scaling optimal transport for high dimensional learning (online talk)*, April 22.
36. R. PYMAR, Birkbeck University of London, Department of Economics, Mathematics and Statistics, *Mixing times of exclusion processes on regular graphs*, February 5.
37. T. ROUBÍČEK, Charles University Prague, Mathematical Institute, Czech Republic, *The old Stefan problem in a new mechanical context (online talk)*, November 11.
38. J. ROUSSEAU, University of Oxford, Department of Statistics, UK, *Bayesian nonparametric estimation in multivariate non-linear Hawkes processes (online talk)*, December 11.
39. J. SCHAUMBURG, Vrije Universiteit Amsterdam, Department of Econometrics and Data Science, Netherlands, *Dynamic clustering of multivariate panel data (online talk)*, May 6.
40. I. STEINWART, Universität Stuttgart, Institut für Stochastik und Anwendungen, *Some thoughts and questions towards a statistical understanding of DNNs (online talk)*, June 24.

41. A. STEPHAN, Deutsches Zentrum für Luft- und Raumfahrt (DLR), Institut für Physik der Atmosphäre, Weßling, *Modeling Navier–Stokes equations for high Reynolds number flows and complex geometries in aerodynamic applications*, February 27.
42. L. STRENGE, Technische Universität Berlin, Fachgebiet Regelungssysteme, *A multilayer, multi-timescale model approach for economic and frequency control in power grids using Julia*, January 9.
43. T. SULLIVAN, Freie Universität Berlin, Institut für Mathematik, *A rigorous theory of conditional mean embeddings*, February 5.
44. C.A. URIBE, Massachusetts Institute of Technology, Laboratory for Information and Decision Systems (LIDS), Cambridge, USA, *Distributed inference for cooperative learning (online talk)*, May 12.
45. I. VAN KEILEGOM, Catholic University of Leuven, Faculty of Economics and Business, Belgium, *On a semi-parametric estimation method for AFT mixture cure models (online talk)*, June 3.
46. A. WALTHER, Humboldt-Universität zu Berlin, Mathematisch-Naturwissenschaftliche Fakultät, *Algorithmic differentiation: Sensitivities, adjoints and nonsmooth optimization (online talk)*, September 3.
47. S. WANG, University of Cambridge, Centre for Mathematical Sciences, UK, *Convergence rates for penalised least squares estimators in PDE-constrained regression problems*, January 15.
48. CH. WIENERS, Karlsruher Institut für Technologie, Fakultät für Mathematik, *A discontinuous Galerkin method for phase field approximations of dynamic fracture (online talk)*, November 19.
49. B. ZALTZMAN, Ben-Gurion University of the Negev, Jacob Blaustein Institute for Desert Research, Sede Boqer Campus, Israel, *Artifact of “Breakthrough” osmosis or what may be wrong with local Spiegler–Kedem–Katchalsky equations with constant coefficients (online talk)*, April 22.
50. ———, *Orientation effects in hydrodynamic instability in concentration polarization (online talk)*, April 29.
51. ———, *Equilibrium electro-convective instability in electrodeposition with Butler–Volmer kinetics (online talk)*, May 6.
52. N. ZHIVOTOVSKIY, Google Research, Brain Team, Zurich, Switzerland, *Fast classification rates in online and statistical learning with abstention (online talk)*, April 21.

A.13 Software

AWC – Adaptive Weights Clustering (contact: V. Spokoiny, phone: +49 30/20372-575, e-mail: vladimir.spokoiny@wias-berlin.de)

AWC is an open source Python package containing implementation of the novel non-parametric clustering algorithm **Adaptive Weights Clustering**. The method is fully automatic and does not require to specify the number of clusters or their structure. The procedure is numerically feasible and applicable for high-dimensional datasets.

More information: <https://www.wias-berlin.de/software/awc/>

AWS – Adaptive Weights Smoothing (contact: J. Polzehl, phone: +49 30/20372-481, e-mail: joerg.polzehl@wias-berlin.de)

AWS is a contributed package within the R-Project for Statistical Computing containing a reference implementation of the **Adaptive Weights Smoothing** algorithms for local constant likelihood and local polynomial regression models. Binaries for several operating systems are available from the Comprehensive R Archive Network (<http://cran.r-project.org>).

More information: <https://www.wias-berlin.de/software/aws/>

BALaser (contact: M. Radziunas, phone: +49 30/20372-441, e-mail: mindaugas.radziunas@wias-berlin.de)

BALaser is the software tool used for simulations of the nonlinear dynamics in high-power edge-emitting **Broad-Area semiconductor Lasers**. It integrates numerically the laterally extended dynamic traveling wave model (one- and two-dimensional partial differential equations), executes different data post-processing routines, and visualizes the obtained data. When required, the traveling-wave-model-based solver is self-consistently coupled to the quasi-three-dimensional inhomogeneous current-spreading and heat-flow solvers, both developed using the WIAS `pdelib` toolkit.

More information: <https://www.wias-berlin.de/software/balaser/>

ddfermi (contact: Th. Koprucki, phone: +49 30/20372-508, e-mail: thomas.koprucki@wias-berlin.de, J. Fuhrmann, phone: +49 30/20372-560, e-mail: juergen.fuhrmann@wias-berlin.de, P. Farrell, phone: +49 30/20372-401, e-mail: patricio.farrell@wias-berlin.de)

`ddfermi` is an open-source software prototype that simulates the carrier transport in classical or organic semiconductor devices based on drift-diffusion models.

The key features are

- finite volume discretization of the semiconductor equations (van Roosbroeck system),
- thermodynamically consistent Scharfetter–Gummel flux discretizations beyond Boltzmann,
- general statistics: Fermi–Dirac, Gauss–Fermi, Blakemore, and Boltzmann,
- generic carrier species concept,
- one-, two- and three-dimensional devices,
- C++ code based on `pdelib` and interfaced via Python,
- in-situ visualization.

Please find further information under <https://www.wias-berlin.de/software/ddfermi/>.

DiPoG (contact: A. Rathsfeld, phone: +49 30/20372-457, e-mail: andreas.rathsfeld@wias-berlin.de)

The program package **DiPoG** (**D**irect and **i**nverse **P**roblems for **o**ptical **G**ratings) provides simulation and optimization tools for periodic diffractive structures with multilayer stacks.

The direct solver computes the field distributions and efficiencies of given gratings for TE and TM polarization as well as, under conical mounting, for arbitrary polygonal surface profiles. The inverse solver deals with the optimal design of gratings, realizing given optical functions, for example, far-field patterns, efficiency, or phase profiles. The algorithms are based on coupled generalized finite/boundary elements and gradient-type optimization methods.

For detailed information please see <https://www.wias-berlin.de/software/DIPOG/>.

LDSL-tool (contact: M. Radziunas, phone: +49 30/20372-441, e-mail: mindaugas.radziunas@wias-berlin.de)

LDSL-tool (**L**ongitudinal **D**ynamics in **S**emiconductor **L**asers) is a **tool** for the simulation and analysis of the nonlinear longitudinal dynamics in multisection semiconductor lasers and different coupled laser devices. This software is used to investigate and design laser devices that exhibit various nonlinear effects such as self-pulsations, chaos, hysteresis, mode switching, excitability, mutual synchronization, and frequency entrainment by an external modulated optical or electrical signal.

LDSL-tool combines models of different complexity, ranging from partial differential equation (PDE) to ordinary differential equation (ODE) systems. A mode analysis of the PDE system, a comparison of the different models, and a numerical bifurcation analysis of PDE systems are also possible.

Detailed information: <https://www.wias-berlin.de/software/ldsl>

WIAS-MeFreSim (contact: A. Rathsfeld, phone: +49 30/20372-457, e-mail: andreas.rathsfeld@wias-berlin.de)

WIAS-MeFreSim allows for the three-dimensional simulation of induction heat treatment for workpieces made of steel using single- and multi-frequency currents. It is the aim of the heat treatment to produce workpieces with hard, wear-resistant surface and soft, ductile core. The boundary layer of the workpiece is heated up by induced eddy currents and rapidly cooled down by the subsequent quenching process. The resulting solid-solid phase transitions lead to a hardening of the surface of the workpiece.

WIAS-MeFreSim is based on the WIAS software **pdelib**. It solves coupled systems of PDEs consisting of Maxwell's equations, the heat equation, and the equations of linear elasticity.

For more information see <https://www.wias-berlin.de/software/MeFreSim/>.

Par Moon (contact: U. Wilbrandt, phone: +49 30/20372-571, e-mail: ulrich.wilbrandt@wias-berlin.de)

Par Moon is a flexible finite element package for the solution of steady-state and time-dependent convection-diffusion-reaction equations, incompressible Navier–Stokes equations, and coupled systems consisting of these types of equations, like population balance systems or systems coupling free flows and flows in porous media.

Please find more information under <http://cmg.cds.iisc.ac.in/parmoon/>.

Important features of **Par Moon** are

- the availability of more than 100 finite elements in one, two, and three space dimensions (conforming, non-conforming, discontinuous, higher-order, vector-valued, isoparametric, with bubbles),
- the use of implicit time-stepping schemes (θ -schemes, DIRK schemes, Rosenbrock–Wanner schemes),
- the application of a multiple-discretization multi-level (MDML) preconditioner in Krylov subspace methods,
- tools for using reduced-order models based on proper orthogonal decomposition (POD) are available,

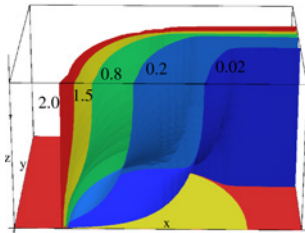

Concentration isosurfaces in a thin-layer flow cell (*pdelib*)

- hybrid parallelization with MPI and OpenMP.

ParMoon is a joint development with the group of Prof. S. Ganesan (IISc Bangalore) and the group of Prof. G. Matthies (TU Dresden).

pdelib (contact: J. Fuhrmann, phone: +49 30/20372-560, e-mail: juergen.fuhrmann@wias-berlin.de, T. Streckenbach, phone: +49 30/20372-476, e-mail: timo.streckenbach@wias-berlin.de)

pdelib is a collection of software components that are useful to create simulators and visualization tools for partial differential equations. The main idea of the package is modularity, based on a bottom-up design realized in the C++ programming language. Among others, it provides

- iterative solvers for linear and nonlinear systems of equations,
- sparse matrix structures with preconditioners and direct solver interfaces,
- dimension-independent simplex grid handling in one, two, and three space dimensions,
- finite-volume-based solution of coupled parabolic reaction-diffusion-convection systems and pressure-robust discretizations for Navier–Stokes,
- finite-element-based solution of variational equations (especially thermoelasticity) with goal-oriented error estimators,
- optimization tool box,
- parallelization on SMP architectures,
- graphical output during computation using OpenGL,
- scripting interface based on the languages Python and Lua,
- graphical user interface based on the FLTK toolkit,
- modular build system and package manager for the installation of third-party software used in the code.

Please see also <https://www.wias-berlin.de/software/pdelib/>.

PDELib.jl (contact: J. Fuhrmann, phone: +49 30/20372-560, e-mail: juergen.fuhrmann@wias-berlin.de, T. Streckenbach, phone: +49 30/20372-476, e-mail: timo.streckenbach@wias-berlin.de, Ch. Merdon, phone: +49 30/20372-452, e-mail: Christian.Merdon@wias-berlin.de)

PDELib.jl is being developed as the successor of *pdelib* in the Julia programming language. It is a collection of open source Julia packages dedicated to the handling of sparse matrices, mesh generation, and visualization. It wraps the Julia package *VoronoiFVM.jl* that implements the Voronoi box based finite volume method for nonlinear systems of partial differential equations and the Julia package *GradientRobustMultiPhysics.jl* implementing gradient robust finite element methods in Julia. Please see also <https://github.com/WIAS-BERLIN/PDELib.jl>.

SPHInX (contact: O. Marquardt, phone: +49 30/20372-474, e-mail: oliver.marquardt@wias-berlin.de)

SPHInX is an open-source C++ library for materials simulation hosted by the Max-Planck-Institut für Eisenforschung GmbH in Düsseldorf, Germany. The multiband $\mathbf{k} \cdot \mathbf{p}$ and continuum elasticity modules of *SPHInX* for the calculation of elastic and optoelectronic properties of semiconductor heterostructures are maintained at WIAS Berlin. Please see <https://srepo.mpie.de/>.

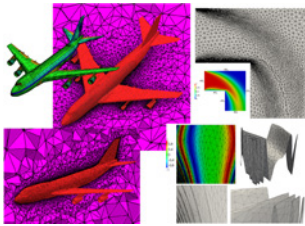

Adapted tetrahedral meshes and anisotropic meshes for numerical methods and scientific computation

TetGen (contact: H. Si, phone: +49 30/20372-446, e-mail: hang.si@wias-berlin.de)

TetGen is a mesh generator for three-dimensional simplex meshes as they are used in finite volume and finite element computations. It generates the Delaunay tetrahedralization, Voronoi diagram, and convex hull for three-dimensional point sets. For three-dimensional domains with piecewise linear boundary, it constructs constrained Delaunay tetrahedralizations and quality tetrahedral meshes. Based on recent research on fundamental algorithms for the generation of tetrahedral meshes, the new version 1.6 provides improvements with respect to the quality of the created meshes and the speed for their creation.

More information is available at <https://www.wias-berlin.de/software/tetgen/>.

WIAS-TeSCA (contact: H. Stephan, phone: +49 30/20372-442, e-mail: holger.stephan@wias-berlin.de)

WIAS-TeSCA is a **Two-dimensional Semi-Conductor Analysis** package. It serves to simulate numerically the charge carrier transport in semiconductor devices based upon the drift-diffusion model. This van Roosbroeck system is augmented by a vast variety of additional physical phenomena playing a role in the operation of specialized semiconductor devices as, e.g., the influence of magnetic fields, optical radiation, temperature, or the kinetics of deep (trapped) impurities.

The strategy of WIAS-TeSCA for solving the resulting highly nonlinear system of partial differential equations is oriented towards the Lyapunov structure of the system describing the currents of electrons and holes within the device. Thus, efficient numerical procedures for both the stationary and the transient simulation were implemented, the spatial structure of which is a finite volume method. The underlying finite element discretization allows the simulation of arbitrarily shaped two-dimensional device structures.

WIAS-TeSCA has been successfully used in the research and development of semiconductor devices such as transistors, diodes, sensors, detectors, lasers, and solar cells.

The semiconductor device simulation package WIAS-TeSCA operates in a Linux environment on desktop computers.

WIAS is currently focusing on the development of a new generation semiconductor simulator prototype. Therefore, WIAS-TeSCA is in maintenance mode and is used for benchmarking of the new code and the support of running projects.

For more information please see <https://www.wias-berlin.de/software/tesca/>.

WIAS Software Collection for Imaging (contact: K. Tabelow, phone: +49 30/20372-564, e-mail: karsten.tabelow@wias-berlin.de)

`adimpro` is a contributed package within the R-Project for Statistical Computing that contains tools for image processing, including structural adaptive smoothing of digital color images. The package is available from the Comprehensive R Archive Network (<http://cran.r-project.org>).

The AWS for AMIRA (TM) plugin implements a structural adaptive smoothing procedure for two- and three-dimensional images in the visualization software AMIRA (TM). It is available in the Zuse Institute Berlin's version of the software for research purposes (<http://amira.zib.de/>).

WIAS Software Collection for Neuroscience (contact: K. Tabelow, phone: +49 30/20372-564, e-mail: karsten.tabelow@wias-berlin.de)

`dmi` is a contributed package within the R-Project for Statistical Computing. The package contains tools for the analysis of diffusion-weighted magnetic resonance imaging data (dMRI). It can be used to read dMRI data, to estimate the diffusion tensor, for the adaptive smoothing of dMRI data, the estimation of the orientation density function or its square root, the estimation of tensor mixture models, the estimation of the diffusion kurtosis model, fiber tracking, and for the two- and three-dimensional visualization of the results. The package is available from the Comprehensive R Archive Network (<http://cran.r-project.org>). The multi-shell position-orientation adaptive smoothing (msPOAS) method for dMRI data is additionally available within the ACID toolbox for SPM (<http://www.diffusioontools.com>).

`fMRI` is a contributed package within the R-Project for Statistical Computing that contains tools to analyze fMRI data with structure-adaptive smoothing procedures. The package is available from the Comprehensive R Archive Network (<http://cran.r-project.org>).

`qMRI` is the third R-package in this collection that contains functions for the analysis of magnetic resonance imaging data acquired in the multi-parameter mapping framework, including the estimation of quantitative model parameters, structural adaptive smoothing methods for noise reduction, and methods for performing a bias correction caused by the low signal-to-noise ratio.

The three R-packages of this collection are included in the Neuroconductor platform for reproducible computational imaging software (<https://neuroconductor.org>).